



PDHonline Course G415 (6 PDH)

DoD Security Engineering Facilities Planning Manual (Part 1)

Instructor: Robert E. Merton, PE

2020

PDH Online | PDH Center

5272 Meadow Estates Drive
Fairfax, VA 22030-6658
Phone: 703-988-0088
www.PDHonline.com

An Approved Continuing Education Provider

UNIFIED FACILITIES CRITERIA (UFC)

DoD Security Engineering Facilities Planning Manual



**DISTRIBUTION STATEMENT A: Approved for Public Release;
Distribution is unlimited.**

UNIFIED FACILITIES CRITERIA (UFC)

DoD Security Engineering Facilities Planning Manual

Any copyrighted material included in this UFC is identified at its point of use. Use of the copyrighted material apart from this UFC must have the permission of the copyright holder.

DEPUTY UNDER SECRETARY OF DEFENSE (INSTALLATIONS AND ENVIRONMENT)

J3, DEPUTY DIRECTORATE FOR ANTITERRORISM AND FORCE PROTECTION, JOINT CHIEFS OF STAFF

U.S. ARMY CORPS OF ENGINEERS (Preparing Activity)

NAVAL FACILITIES ENGINEERING COMMAND

AIR FORCE CIVIL ENGINEER SUPPORT AGENCY

Record of Changes (changes are indicated by \1\ ... /1/)

Change No.	Date	Location

FOREWORD

The Unified Facilities Criteria (UFC) system is prescribed by MIL-STD 3007 and provides planning, design, construction, sustainment, restoration, and modernization criteria, and applies to the Military Departments, the Defense Agencies, and the DoD Field Activities in accordance with [USD\(AT&L\) Memorandum](#) dated 29 May 2002. UFC will be used for all DoD projects and work for other customers where appropriate. All construction outside of the United States is also governed by Status of forces Agreements (SOFA), Host Nation Funded Construction Agreements (HNFA), and in some instances, Bilateral Infrastructure Agreements (BIA.) Therefore, the acquisition team must ensure compliance with the more stringent of the UFC, the SOFA, the HNFA, and the BIA, as applicable.

UFC are living documents and will be periodically reviewed, updated, and made available to users as part of the Services' responsibility for providing technical criteria for military construction. Headquarters, U.S. Army Corps of Engineers (HQUSACE), Naval Facilities Engineering Command (NAVFAC), and Air Force Civil Engineer Support Agency (AFCESA) are responsible for administration of the UFC system. Defense agencies should contact the preparing service for document interpretation and improvements. Technical content of UFC is the responsibility of the cognizant DoD working group. Recommended changes with supporting rationale should be sent to the respective service proponent office by the following electronic form: [Criteria Change Request \(CCR\)](#). The form is also accessible from the Internet sites listed below.

UFC are effective upon issuance and are distributed only in electronic media from the following source:

- Whole Building Design Guide web site <http://dod.wbdg.org/>.

Hard copies of UFC printed from electronic media should be checked against the current electronic version prior to use to ensure that they are current.

AUTHORIZED BY:

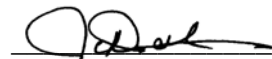

JAMES C. DALTON, P.E.
Chief, Engineering and Construction
U.S. Army Corps of Engineers



PAUL A. PARKER
The Deputy Civil Engineer
DCS/Installations & Logistics
Department of the Air Force



JOSEPH E. GOTT, P.E.
Chief Engineer
Naval Facilities Engineering Command



Dr. GET W. MOY, P.E.
Director, Installations Requirements and
Management
Office of the Deputy Under Secretary of Defense
(Installations and Environment)

This page intentionally left blank

**Unified Facilities Criteria (UFC)
New Document Summary Sheet**

Subject: UFC 4-020-01, DoD Security Engineering Facilities Planning Manual

Cancels: UFC 4-020-01 FA, Security Engineering Project Development

Document Description and Need:

- **Purpose:** This UFC supports the planning of DoD facilities that include requirements for security and antiterrorism. It will be used in conjunction with UFC 4-010-01, *DoD Minimum Antiterrorism Standards for Buildings*, to establish the security and antiterrorism design criteria that will be the basis for DoD facility designs. Those criteria include the assets to be protected, the threats to those assets, the levels to which those assets are to be protected against those threats, and any design constraints imposed by facility users. This document also provides a means for identifying the costs for providing the applicable levels of protection and a risk management process for evaluating those costs and the protection options.
- **Application and Use:** Commanders, security and antiterrorism personnel, planners, and other members of project planning teams will use this UFC to establish project specific design criteria for DoD facilities, estimate the costs for implementing those criteria, and evaluating both the design criteria and the options for implementing it. The design criteria and costs will be incorporated into project programming documents. This UFC also provides guidance for incorporation of security and antiterrorism principles into installation master planning.
- **Need:** This UFC is one in a series of security engineering Unified Facilities Criteria that address minimum standards, planning, preliminary design, and detailed design for security and antiterrorism. This UFC provides the starting point for application of all of the manuals within the security engineering series. Without this UFC, there would be no standardized DoD-wide process for identifying and justifying design criteria for security and antiterrorism and no basis for applying the other manuals in the series.

Impact. The following direct benefits will result from publication of UFC 4-020-01:

- Creates a standardized approach for identifying and justifying security and antiterrorism design criteria for DoD facilities
- Creates standardized nomenclature and criteria for asset, threat, and level of protection definition.
- Creates a standardized procedure for identifying costs for DoD facilities with security and antiterrorism requirements to a planning level of detail.
- Creates a standardized process for evaluating design criteria and protection options based on cost and risk management.
- Provides guidance for incorporating security and antiterrorism principles into installation master planning.
- Does not have any adverse impacts on environmental, sustainability, or constructability policies or practices.

This page intentionally left blank

CONTENTS

		<u>Page</u>
CHAPTER 1 INTRODUCTION		
Paragraph	1-1	BACKGROUND 1-1
	1-2	PURPOSE 1-1
	1-3	SCOPE 1-1
	1-3.1	Design Criteria Development 1-1
	1-3.2	Cost Increase Identification 1-2
	1-3.3	Cost Increase Justification 1-2
	1.4	APPLICABILITY 1-2
	1-5	REFERENCES 1-2
	1-6	THE PLANNING TEAM..... 1-3
	1-6.1	Facility User 1-3
	1-6.2	Antiterrorism..... 1-3
	1-6.3	Intelligence 1-3
	1-6.4	Operations 1-3
	1-6.5	Security 1-3
	1-6.6	Logistics 1-4
	1-6.7	Engineering..... 1-4
	1-6.8	Resource Management..... 1-4
	1-6.9	Others 1-4
	1-7	INTEGRATING WITH OTHER REQUIREMENTS . 1-4
	1-7.1	Security Regulations 1-4
	1-7.2	Explosives Safety..... 1-4
	1-7.3	Other DoD Component Standards 1-5
	1-7.4	Historic Preservation 1-5
	1-7.5	Sustainable Design 1-5
	1-7.6	Other Facility Requirements..... 1-5
	1-8	SECURITY ENGINEERING UFC SERIES 1-6
	1-8.1	DoD Minimum Antiterrorism Standards for Buildings 1-6
	1-8.2	Security Engineering Planning Manual 1-6
	1-8.3	Security Engineering Design Manual 1-6
	1-8.4	Security Engineering Support Manuals 1-6
	1-9	Security Engineering UFC Application 1-7
 CHAPTER 2 AGGRESSOR THREATS AND TACTICS		
Paragraph	2-1	INTRODUCTION..... 2-1
	2-2	AGGRESSORS..... 2-1
	2-2.1	Aggressor Objectives 2-1
	2-2.2	Aggressor Categories 2-1
	2-3	AGGRESSOR TACTICS..... 2-4
	2-3.1	Moving Vehicle Bomb Tactic..... 2-4
	2-3.2	Stationary Vehicle Bomb Tactic 2-4
	2-3.3	Hand Delivered Device Tactic..... 2-4
	2-3.4	Indirect Fire Weapons Tactic 2-5

2-3.5	Direct Fire Weapons Tactic.....	2-5
2-3.6	Forced Entry Tactic.....	2-5
2-3.7	Covert Entry Tactic.....	2-5
2-3.8	Visual Surveillance Tactic	2-5
2-3.9	Acoustic Eavesdropping Tactic	2-5
2-3.10	Electronic Emanations Eavesdropping Tactic	2-5
2-3.11	Airborne Contamination Tactic.....	2-6
2-3.12	Waterborne Contamination Tactic.....	2-6
2-3.13	Waterfront Attacks.....	2-6
2-3.14	Tactics Not Addressed	2-6
2-4	TOOLS, WEAPONS, EXPLOSIVES, AND AGENTS	2-6
2-4.1	Tools	2-7
2-4.2	Weapons.....	2-8
2-4.3	Explosives.....	2-9
2-4.4	Chemical, Biological, and Radiological Agents	2-10

CHAPTER 3 DESIGN CRITERIA DEVELOPMENT

Paragraph	3-1	INTRODUCTION.....	3-1
	3-1.1	Design Criteria	3-2
	3-1.2	Other Standards.....	3-2
	3-1.3	Priority.....	3-2
	3-1.4	Risk Management	3-2
	3-2	USING THIS PROCEDURE.....	3-3
	3-3	STEP 1: CONVENE THE PLANNING TEAM.....	3-7
	3-4	STEP 2: IDENTIFY ASSETS	3-7
	3-4.1	Determine Facility Types.....	3-7
	3-4.2	Determine Default Assets	3-7
	3-5	STEP 3: DETERMINE ASSET VALUE	3-9
	3-5.1	Value Rating Factors.....	3-9
	3-5.2	Determine Asset Value Rating	3-21
	3-5.3	Eliminate Assets with “Very Low” Value Ratings....	3-21
	3-6	STEP 4: IDENTIFY AGGRESSOR LIKELIHOODS	3-21
	3-6.1	Select Applicable Aggressors	3-21
	3-6.2	Assess Aggressor Likelihood Ratings	3-21
	3-6.3	Determine Likelihood Ratings	3-34
	3-6.4	Aggressors With “Very Low” Likelihood Ratings	3-34
	3-7	STEP 5: IDENTIFY TACTICS AND THREAT SEVERITY LEVELS.....	3-35
	3-7.1	Select Applicable Tactics Based on Assets	3-35
	3-7.2	Select Applicable Tactics Based on Aggressors	3-35
	3-7.3	Identify Threat Severity Levels.....	3-35
	3-8	STEP 6: CONSOLIDATE INTO INITIAL DESIGN BASIS THREAT	3-40
	3-8.1	Initial Design Basis Threat	3-40
	3-8.2	Modifying the Initial Design Basis Threat	3-40

3-9	STEP 7: DETERMINE INITIAL LEVEL OF PROTECTION	3-42
3-9.1	Initial Level of Protection	3-43
3-9.2	Example	3-43
3-9.3	Modifying the Initial Level of Protection.....	3-43
3-10	STEP 8: DETERMINE PLANNING RISK LEVELS	3-43
3-10.1	Determine Threat Effectiveness Ratings.....	3-43
3-10.2	Select Initial Protection Factors.....	3-45
3-10.3	Calculate Average Initial Protection Factors	3-47
3-10.4	Adjust Initial Protection Factors.....	3-47
3-10.5	Determine Risk Level	3-47
3-11	STEP 9: ASSESS ACCEPTIBILITY OF RISK LEVELS	3-48
3-11.1	Cost and Risk Evaluation	3-48
3-11.2	Cost and Risk Analysis	3-49
3-12	STEP 10: IDENTIFY USER CONSTRAINTS.....	3-51
3-12.1	Political Considerations.....	3-51
3-12.2	Financial Considerations.....	3-51
3-12.3	Regulations	3-51
3-12.4	Procedural or Operational Considerations	3-51
3-12.5	Facility and Site Constraints.....	3-52
3-12.6	Response Force.....	3-53
3-12.7	Response Time	3-53
3-12.8	Manpower Allocation.....	3-53
3-13	INFORMATION SENSITIVITY	3-54
3-13.1	Derivative Classification	3-54
3-13.2	Classification Guides.....	3-54
3-13.3	Original Classification.....	3-54

CHAPTER 4 DESIGN STRATEGIES

Paragraph	4-1	INTRODUCTION.....	4-1
	4-1.1	General Design Strategy.....	4-1
	4-1.2	Specific Design Strategy	4-1
	4-1.3	Project Scope Implications.....	4-1
	4-2	VEHICLE BOMB TACTICS	4-2
	4-2.1	General Design Strategy.....	4-2
	4-2.2	Specific Design Strategies	4-3
	4-2.3	Project Scope Implications.....	4-6
	4-3	HAND DELIVERED DEVICES.....	4-11
	4-3.1	General Design Strategy.....	4-11
	4-3.2	Specific Design Strategies	4-11
	4-3.3	Project Scope Implications.....	4-12
	4-4	INDIRECT FIRE WEAPONS.....	4-16
	4-4.1	General Design Strategy.....	4-16
	4-4.2	Specific Design Strategies	4-16
	4-4.3	Project Scope Implications.....	4-18

4-5	DIRECT FIRE WEAPONS	4-21
4-5.1	General Design Strategy	4-21
4-5.2	Specific Design Strategy	4-21
4-5.3	Project Scope Implications.....	4-22
4-6	AIRBORNE CONTAMINATION TACTIC	4-24
4-6.1	General Design Strategy	4-24
4-6.2	Specific Design Strategies	4-24
4-6.3	Project Scope Implications.....	4-25
4-7	WATERBORNE CONTAMINATION TACTIC	4-26
4-7.1	General Design Strategy	4-27
4-7.2	Specific Design Strategies	4-27
4-7.3	Project Scope Implications.....	4-28
4-8	WATERFRONT ATTACK TACTIC.....	4-30
4-8.1	General Design Strategy	4-30
4-8.2	Specific Design Strategies	4-30
4-8.3	Project Scope Implications.....	4-31
4-9	FORCED ENTRY TACTIC	4-31
4-9.1	General Design Strategy	4-31
4-9.2	Specific Design Strategy	4-32
4-9.3	Project Scope Implication.....	4-33
4-10	COVERT ENTRY TACTIC	4-34
4-10.1	General Design Strategy	4-34
4-10.2	Specific Design Strategy	4-35
4-10.3	Project Scope Implications.....	4-35
4-11	VISUAL SURVEILLANCE TACTIC	4-37
4-11.1	General Design Strategy	4-37
4-11.2	Specific Design Strategy	4-37
4-11.3	Project Scope Implications.....	4-37
4-12	ACOUSTIC EAVESDROPPING TACTIC.....	4-38
4-12.1	General Design Strategy	4-38
4-12.2	Specific Design Strategy	4-38
4-12.3	Project Scope Implications.....	4-39
4-13	ELECTRONIC EMANATIONS EAVESDROPPING TACTIC	4-40
4-13.1	General Design Strategy	4-40
4-13.2	Specific Design Strategy	4-40
4-13.3	Project Scope Implications.....	4-40

CHAPTER 5 MASTER PLANNING CONSIDERATIONS

Paragraph	5-1	INTRODUCTION.....	5-1
	5-2	SECURITY AND ANTITERRORISM PLANNING...	5-1
	5-3	ISSUES IN MASTER PLANNING	5-2
	5-3.1	Land Use Planning.....	5-2
	5-3.2	Site Planning and Space Management.....	5-3
	5-3.3	Vehicle Access and Circulation.....	5-4

CHAPTER 6 PROJECT COST DEVELOPMENT

Paragraph	6-1	INTRODUCTION.....	6-1
	6-2	BUILDING TYPES	6-1
	6-3	BASELINE COSTS.....	6-1
	6-4	NEW BUILDING CONSTRUCTION.....	6-1
	6-5	EXISTING BUILDING CONSTRUCTION.....	6-2
	6-6	SITework COSTS.....	6-2
	6-7	DETERMINING NEW CONSTRUCTION COST INCREASES	6-2
	6-7.1	Determine Representative Building Types	6-2
	6-7.2	Determine Facility Baseline Cost	6-3
	6-7.3	Find Applicable Cost Tables	6-3
	6-7.4	Find the Cost Increase	6-3
	6-7.5	Resolve Construction Components.....	6-3
	6-7.6	Determine Facility Cost Increase	6-3
	6-7.7	Record the Cost Increase	6-3
	6-8	DETERMINING RETROFIT CONSTRUCTION COST INCREASES	6-3
	6-8.1	Determine Representative Building Type.....	6-3
	6-8.2	Determine Facility Baseline Cost	6-4
	6-8.3	Find Applicable Cost Tables	6-4
	6-8.4	Find the Cost Increase	6-4
	6-8.5	Resolve Construction Components.....	6-4
	6-8.6	Determine Facility Cost Increase	6-4
	6-8.7	Record the Cost Increase	6-4
	6-9	DETERMINING SITework COSTS.....	6-4
	6-9.1	Identify Applicable Tactic and Threat Severity Level	6-5
	6-9.2	Identify Costs of Baseline Barriers	6-5
	6-9.3	Find Applicable Barrier Multiplier.....	6-5
	6-9.4	Identify the Applicable Quantities	6-5
	6-9.5	Determine Barrier Costs.....	6-5
	6-9.6	Record Barrier Costs.....	6-5
	6-10	EXAMPLE PROBLEM.....	6-5
	6-10.1	Building Cost Increase	6-6
	6-10.2	Barrier Costs	6-9
GLOSSARY		G-1
APPENDIX A	NEW CONSTRUCTION COST TABLES		A-1
APPENDIX B	RETROFIT CONSTRUCTION COST TABLES		B-1
APPENDIX C	CONSOLIDATED CONSTRUCTION COMPONENT TABLES		C-1
APPENDIX D	EXPEDITIONARY CONSTRUCTION COSTS		D-1
APPENDIX E	BLANK WORKSHEETS		E-1

FIGURES

Figure	Title	
1-1	Security Engineering UFC Application	1-8
3-1	Design Criteria	3-1
3-2	The Design Criteria Development Procedure	3-4
3-3	Sample Design Criteria Summary Worksheet.....	3-11
3-4	Sample Asset Value/Aggressor Likelihood Worksheet	3-22
3-5	Sample Tactic and Threat Severity Level Worksheet	3-36
3-6	Sample Risk Level Calculation Worksheet	3-46
3-7	Sample Building Cost and Risk Evaluation Worksheet.....	3-50
4-1	Standoff Zones	4-7
4-2	Passive Perimeter Barriers for Stationary Vehicle Bombs	4-8
4-3	Passive Perimeter Barriers for Moving Vehicle Bombs.....	4-8
4-4	Active Vehicle Barriers for Stationary Vehicle.....	4-9
4-5	Active Vehicle Barriers for Moving Vehicle Tactic.....	4-9
4-6	Entry Foyer to Reduce Door Hazards.....	4-10
4-7	Site Design Example for High Level of Protection	4-13
4-8	Entry and Delivery Points.....	4-15
4-9	Narrow Windows.....	4-19
4-10	Sacrificial Roof and Exterior Foyers.....	4-20
4-11	Shielded SEA Hut Cluster.....	4-21
4-12	Modular TEMPEST Enclosure	4-41
5-1	Consolidated vs. Separated Facilities	5-5
5-2	Opportunities for Observation from Adjacent Facilities	5-5
5-3	Road Modifications to Reduce Speed.....	5-7
5-4	Installation Vehicle Circulation Modifications	5-7
5-5	Road Closure to Create Standoff.....	5-8
5-6	Parking and Roadway Modifications.....	5-8

TABLES

3-1	Common Facility Types	3-8
3-2	Default Assets.....	3-10
3-3	Value Rating Factor Applicability	3-12
3-4	Criticality to User / Mission Impact/ Population Type	3-13
3-5	Impact on the National Defense.....	3-14
3-6	Asset Replacement.....	3-15
3-7	Perceived Political Sensitivity	3-15
3-8	Relative Value to User	3-18
3-9	Potential Aggressors and Default Goals	3-23
3-10	Installation Location	3-24
3-11	Installation or Facility Publicity Profile.....	3-24
3-12	Asset Accessibility	3-25
3-13	Asset Availability.....	3-25
3-14	Asset Dynamics	3-26

3-15	Recognizability.....	3-26
3-16	Relative Value to Aggressors.....	3-28
3-17	Law Enforcement Personnel Visibility.....	3-30
3-18	Aggressors' Perception of Success	3-31
3-19	Threat Level.....	3-32
3-20	History of Acts Against Like Assets / Terrorist Intentions.....	3-33
3-21	Terrorist Operational Capability	3-33
3-22	Terrorist Operating Environment.....	3-34
3-23	Terrorist Activity	3-34
3-24	Applicable Asset / Tactic Selection	3-37
3-25	Applicable Aggressor / Tactic Selection.....	3-38
3-26	Threat Severity Selection.....	3-39
3-27	Threat Parameters.....	3-41
3-28	Applicable Levels of Protection.....	3-44
3-29	Threat Effectiveness Ratings	3-45
3-30	Initial Protection Factors	3-45
4-1	Levels of Protection-New and Existing Buildings	4-4
4-2	Levels of Protection-Expeditionary and Temporary Structures	4-5
4-3	Manpower and Procedures Goals for Vehicle Bomb Tactics ..	4-5
4-4	STC Ratings for Levels of Protection	4-39
6-1	Example Problem Building Components.....	6-8
6-2	Illustrative DD Form 1391 Front Page Cost Presentation	6-10

This page intentionally left blank

CHAPTER 1

INTRODUCTION

1-1 **BACKGROUND.** In December 1999 DoD published the *Interim Department of Defense Antiterrorism / Force Protection Construction Standards*, which was the first attempt by DoD to ensure that antiterrorism standards were incorporated into the planning, programming, and budgeting for the design and construction of military facilities. Those standards were replaced by UFC 4-010-01, the *DoD Minimum Antiterrorism Standards for Buildings*. The development of minimum standards for protecting DoD personnel against terrorist acts was required by Title 10 U.S. Code, Subtitle A, PART IV, CHAPTER 169, SUBCHAPTER III, §2859 and implemented by DoD Instruction 2000.16.

The minimum standards provide baseline minimum levels of protection with which all DoD inhabited buildings must comply as long as they meet specific “triggers”. Those levels of protection can be achieved using conventional construction if certain minimum standoff distances are provided. There needed to be guidance for how to design buildings where the minimum standoff distances were not available. In addition, there needed to be guidance for providing higher levels of protection where users could justify them, for addressing threats other than terrorist threats, and for addressing protection of assets other than people.

Up until the development of the security engineering series of UFC, there was no DoD-wide standardized process for identifying and justifying design criteria beyond the minimum standards, which resulted in a wide range of solutions. Some of those solutions provided unjustifiably high levels of protection or protection to unrealistic threats. Some resulted in unreasonably low levels of protection. Design and planning guidance was spread among multiple service specific documents that were neither coordinated nor uniform. This UFC is intended to provide the uniformity and consistency in planning for security and antiterrorism that were not previously available.

1-2 **PURPOSE.** The purpose of this UFC is to support planning of projects that include requirements for security and antiterrorism. Those requirements come from the *DoD Minimum Antiterrorism Standards for Buildings*, combatant command standards, standards from other DoD components or commands, regulations, or installation or user requirements. Projects include new construction, existing construction or expeditionary and temporary construction. The intended users of this UFC are engineering planners responsible for project development and planning teams responsible for developing design criteria for projects. The ultimate purpose of this guidance is to develop appropriate, effective, unobtrusive, and economical protective designs to a level appropriate for project programming and to provide commanders with the information they need to allocate resources.

1-3 **SCOPE.** The scope of this UFC includes the following:

1-3.1 **Design Criteria Development.** This UFC includes a process for defining the design criteria for a protective system that protects important assets associated with

a permanent facility or one in an expeditionary environment. The design criteria will consist of the assets to be protected, the threats to those assets, the degree to which those assets will be protected against the threat, and any constraints that might be imposed on a design. The design criteria may be limited to that defined in minimum standards or it may go beyond those requirements.

1-3.2 **Cost Increase Identification.** This UFC includes a process for identifying the increases in cost associated with protecting the identified assets to the applicable threat and to the appropriate level of protection over that of conventional construction.

1-3.3 **Cost Increase Justification.** The processes in this UFC provide a basis for justifying increased project costs related to security and antiterrorism in programming documents using relative risk to ensure the added costs are not deleted in the budgetary process.

1-4 **APPLICABILITY.** This UFC applies to all DoD components and to all DoD assets and facilities that are owned, leased, privatized, or otherwise occupied, managed, or controlled by or for DoD.

1-5 **REFERENCES**

- Interim Department of Defense Antiterrorism / Force Protection Construction Standards, December 16, 1999 (cancelled by UFC 4-010-01)
- DoD Instruction 2000.16, DoD Antiterrorism Standards, 14 June 2001.
- DoD O-2000.12-H, DoD Antiterrorism Handbook, 9 February 2004
- DoD Manual 5100.76-M, Physical Security of Sensitive Conventional Arms, Ammunition, and Explosives, 12 August 2000
- Unified Facilities Criteria (UFC) 3-701-05, DoD Facilities Pricing Guide, March 2005
- Unified Facilities Criteria (UFC) 4-010-01, DoD Minimum Antiterrorism Standards for Buildings, 8 October 2003
- Unified Facilities Criteria (UFC) 4-010-02, DoD Minimum Antiterrorism Standoff Distances for Buildings; (For Official Use Only (FOUO)) 8 October 2003
- Unified Facilities Criteria (UFC) 4-020-02, DoD Security Engineering Facilities Design Manual, (Draft)
- DoD 6055.9-STD, DoD Ammunition and Explosive Safety Standards, 5 October 2004

- United States European Command (USEUCOM) Antiterrorism Operations Order 08-01, January, 2008 (For Official Use Only (FOUO))
- United States Central Command (USCENTCOM) Operations Order 05-01, *Antiterrorism*, 10 August 2005
- Army Field Manual 3-9, Navy Publication P-467, Air Force Manual 355-7, Potential Military Chemical/Biological Agents and Compounds, 12 December 1990
- Army Field Manual 3-6, Air Force Manual 105-7, Fleet Marine Field Manual 7-11-H, Field Behavior of NBC Agents (Including Smoke and Incendiaries), 3 November 1986

1-6 **THE PLANNING TEAM.** Establishing the design criteria for security and antiterrorism is not something that can be done effectively by any one person. It requires a team of people to ensure that the varied interests relating to a project are considered appropriately. The specific membership of a planning team will be based on local considerations, but in general, the following functions should be represented.

1-6.1 **Facility User.** The ultimate users of the planned facility identify the assets within the facility that will require protection and establish their relative value. The users also identify any special operational or logistical design constraints for the facility.

1-6.2 **Antiterrorism.** DoD Instruction 2000.16 requires every installation or base to have an antiterrorism officer. The role of the antiterrorism officer is to orchestrate the development of comprehensive antiterrorism plans and to coordinate the efforts of all organizations on the installations with respect to antiterrorism preparation and response. As such, the antiterrorism officer is a critical member of the planning team.

1-6.3 **Intelligence.** Representatives of this function are responsible for providing input for the identification of threats to identified assets including information on potential aggressors, their likely targets, and their likely tactics. Because the scope of security engineering potentially includes criminals, terrorists, subversives, and foreign intelligence agents, the intelligence role might not be represented by one person or organization. Criminal intelligence and terrorist intelligence may be in different organizations, for example. This varies by DoD component and location.

1-6.4 **Operations.** Representatives of this function may be considered to serve as installation level user representatives or representatives of the senior tactical commander on an installation. The installation antiterrorism office and the responsibility for antiterrorism commonly reside in operations.

1-6.5 **Security.** Representatives of the security and law enforcement function are responsible for detecting and defeating acts of aggression against assets. Therefore, these representatives supply information about the response capabilities of military police, contract or security guards, local police, or other applicable security

forces. They may also provide information on general security requirements and on criminal threats.

1-6.6 **Logistics.** Representatives of this function are commonly responsible for maintenance of installed equipment in facilities. They provide input on equipment maintenance and on integrating with existing systems.

1-6.7 **Engineering.** Representatives of this function are responsible for facility planning, design, construction, maintenance, and repair. The Director of Public Works (DPW) or Base Civil Engineer (BCE) (or equivalent) organizations commonly include the master planner or project programmer. The programmer organizes and leads the planning team; consolidates all facility requirements, design criteria, and project cost information into the appropriate programming documents; and establishes the project cost estimate or budget.

1-6.8 **Resource Management.** The resource manager will be responsible for obtaining the funds necessary to implement whatever projects are formulated as part of this process. They are also familiar with what funds sources are available and with the requirements for programming those funds.

1-6.9 **Others.** Based on local considerations, there may be others who should be consulted for input into the design criteria. They might include Fire Marshals, communications people, environmental people, and historic preservation officers.

1-7 **INTEGRATING WITH OTHER REQUIREMENTS.** Security and antiterrorism requirements will never be the only requirements associated with a project. Even where a project is specifically for security and antiterrorism upgrades, there will still be other requirements that must be considered. There will be times where one criterion is more stringent than another, in which case the more stringent one must be applied. In some cases, criteria may conflict. In those cases, those conflicts must be resolved, which may require compromise or adjustment to one or the other criteria. The following are examples of common criteria that must be integrated with security and antiterrorism requirements.

1-7.1 **Security Regulations.** Many security regulations specify protective measures, policies, and operations related to security. This UFC is intended to complement those existing regulations, not to contradict or supersede them. Regulatory requirements must be accommodated and coordinated.

1-7.2 **Explosive Safety.** Antiterrorism standards establish criteria to minimize the potential for mass casualties and progressive collapse from a terrorist attack. In addition, based on application of this UFC, planning teams may identify higher levels of protection against explosives threats than are mandated by the minimum standards. DoD 6055.9-STD, *DoD Ammunition and Explosive Safety Standards* as implemented by Service component explosive safety standards, establish acceptable levels of protection for accidental explosions of DoD-titled munitions. The explosive safety and antiterrorism standards address hazards associated with unique events; therefore, they

may specify different levels of protection. Compliance with both standards is required. Where conflicts arise, the more stringent criteria will govern.

1-7.3 **Other DoD Component Standards.** DoD components and Combatant Commanders are allowed to supplement the *DoD Minimum Antiterrorism Standards for Buildings*, but those supplemental requirements may not be less stringent. Examples of such supplemental requirements include USEUCOM Operations Order 08-01 and USCENTCOM Operations Order 05-01. Those operations orders establish additional construction standards for projects constructed in the European and Central Command areas of operations. In addition, DoD components may establish implementing instructions for applying the *DoD Minimum Antiterrorism Standards for Buildings*, which need to be taken into account in project planning.

1-7.4 **Historic Preservation.** Implementation of security and antiterrorism requirements cannot supersede the DoD obligation to comply with federal laws regarding cultural resources to include the National Historic Preservation Act and the Archaeological Resources Protection Act. The planning team needs to determine possible adverse effects upon an historic structure and/or archaeological resource in conjunction with establishing antiterrorism and security requirements to the greatest extent possible and to consult accordingly. Personnel at installations abroad should coordinate with the host nation regarding possible adverse effects to cultural resources. Conversely, historic preservation compliance does not negate the requirement to implement security and antiterrorism standards and requirements. Federal agencies are always the decision-maker in the Section 106 process of the National Historic Preservation Act. An agency should not allow for prolonged consultations that conflict with the eminent need to implement security and antiterrorism standards and requirements. Preservation issues need to be quickly and effectively resolved to avoid obstructing security and antiterrorism efforts.

1-7.5 **Sustainable Design.** Sustainable design seeks to reduce negative impacts on the environment and on the health and comfort of building occupants, thereby improving building performance. The basic objectives of sustainability are to reduce consumption of non-renewable resources, minimize waste, and create healthy, productive environments. Requirements for security and antiterrorism may pose challenges for sustainable design, but the two goals are not mutually exclusive. Two of the most significant areas of conflict are in providing plantings close to buildings for shading and water conservation and in maximizing natural lighting. Issues such as those require careful coordination among design disciplines and may require tradeoffs.

1-7.6 **Other Facility Requirements.** Project programmers and designers also must consider issues such as life safety and fire protection, functional issues, energy conservation, seismic criteria, barrier-free handicapped access, and aesthetics. Protective measures may enhance energy conservation or seismic survivability, but the objectives of life safety requirements or barrier-free access may conflict with the objectives of the protective system. The programmer and the planning team need to recognize conflicts and establish priorities in the programming phase to guide designers to appropriate and optimal solutions.

1-8 **SECURITY ENGINEERING UFC SERIES.** This UFC is one of a series of security engineering Unified Facilities Criteria documents that cover minimum standards, planning, preliminary design, and detailed design for security and antiterrorism. The manuals in this series are designed to be used sequentially by a diverse audience to facilitate development of projects throughout the design cycle. The manuals in this series include the following:

1-8.1 **DoD Minimum Antiterrorism Standards for Buildings.** UFC 4-010-01 and 4-010-02 establish standards that provide minimum levels of protection against terrorist attacks for the occupants of all DoD inhabited buildings. Those UFC are intended to be used by security and antiterrorism personnel and design teams to identify the minimum requirements that must be incorporated into the design of all new construction and major renovations of inhabited DoD buildings. They also include recommendations that should be, but are not required to be incorporated into all such buildings.

1-8.2 **Security Engineering Facilities Planning Manual.** This manual presents processes for developing the design criteria necessary to incorporate security and antiterrorism into DoD facilities and for identifying the cost implications of applying those design criteria. Those design criteria may be limited to the requirements of the minimum standards, or they may include protection of assets other than those addressed in the minimum standards (people), aggressor tactics that are not addressed in the minimum standards, or levels of protection beyond those required by the minimum standards. The cost implications for security and antiterrorism are addressed as cost increases over conventional construction for common construction types. The changes in construction represented by those cost increases are tabulated for reference, but they represent only representative construction that will meet the requirements of the design criteria. The manual also addresses the tradeoffs between cost and risk. The Security Engineering Facilities Planning Manual is intended to be used by planners as well as security and antiterrorism personnel with support from planning team members.

1-8.3 **Security Engineering Facilities Design Manual.** UFC 4-020-02 provides interdisciplinary design guidance for developing preliminary systems of protective measures to implement the design criteria established using UFC 4-020-01. Those protective measures include building and site elements, equipment, and the supporting manpower and procedures necessary to make them all work as a system. The information in UFC 4-020-02 is in sufficient detail to support concept level project development, and as such can provide a good basis for a more detailed design. The manual also provides a process for assessing the impact of protective measures on risk. The primary audience for the Security Engineering Design Manual is the design team, but it can also be used by security and antiterrorism personnel.

1-8.4 **Security Engineering Support Manuals.** In addition to the standards, planning, and design UFCs mentioned above, there is a series of additional UFCs that provide detailed design guidance for developing final designs based on the preliminary

designs developed using UFC 4-020-02. These support manuals provide specialized, discipline specific design guidance. Some address specific tactics such as direct fire weapons, forced entry, or airborne contamination. Others address limited aspects of design such as resistance to progressive collapse or design of portions of buildings such as mail rooms. Still others address details of designs for specific protective measures such as vehicle barriers or fences. The Security Engineering Support Manuals are intended to be used by the design team during the development of final design packages.

1-9 Security Engineering UFC Application. The application of the security engineering series of UFCs is illustrated in Figure 1-1. This manual is intended to be the starting point for any project that is likely to have security or antiterrorism requirements. By beginning with this UFC, the design criteria will be developed that establishes which of the other UFCs in the series will need to be applied. The design criteria may indicate that only the minimum standards need to be incorporated, or it may include additional requirements, resulting in the need for application of additional UFCs. Even if only the minimum standards are required other UFCs may need to be applied if sufficient standoff distances are unavailable. Applying this series of UFCs in the manner illustrated in Figure 1-1 will result in the most efficient use of resources for protecting assets against security and antiterrorism related threats.

Figure 1-1. Security Engineering UFC Application

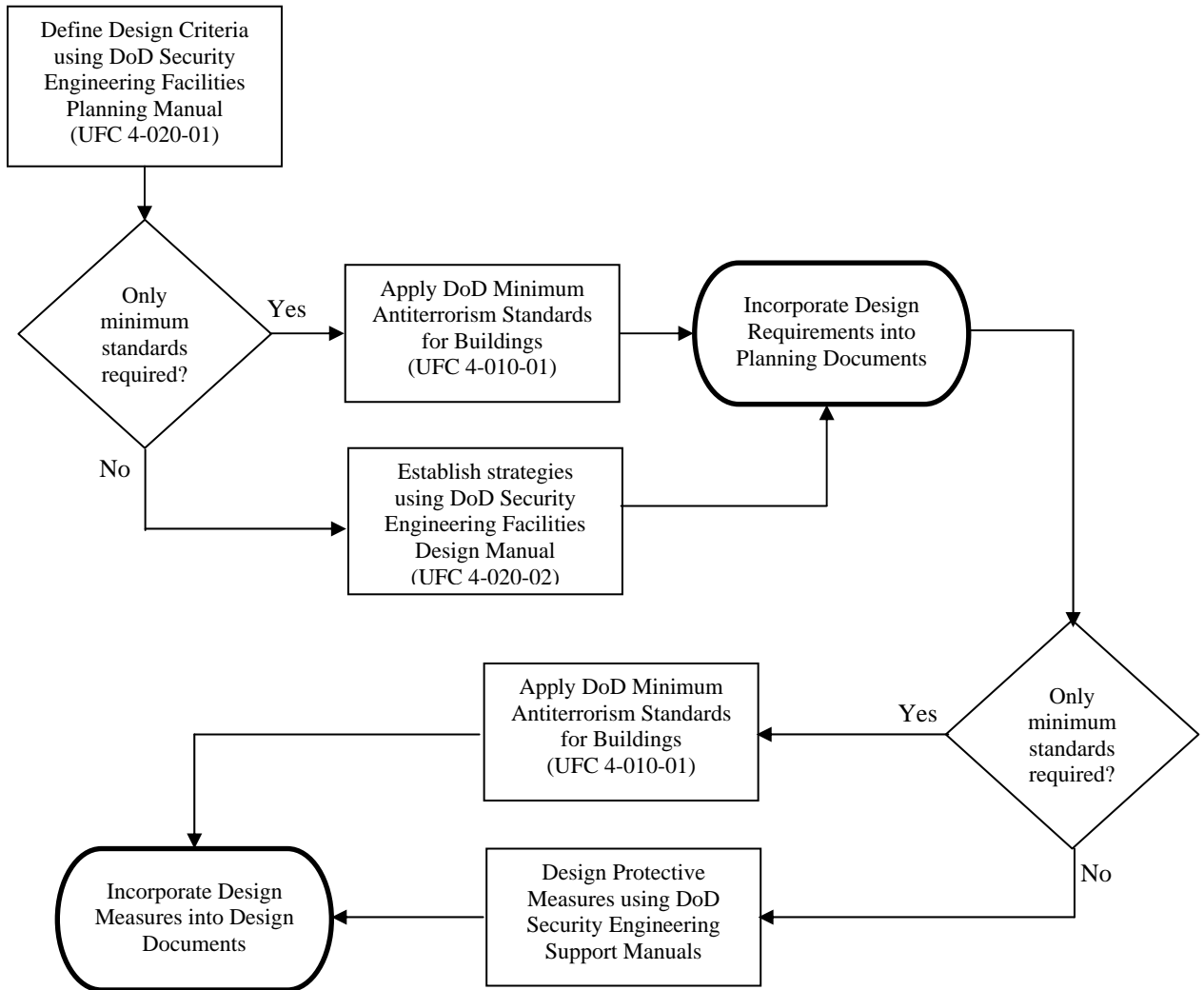

CHAPTER 2

AGGRESSOR THREATS AND TACTICS

2-1 **INTRODUCTION.** Historical patterns and trends in aggressor activity indicate general categories of aggressors and the common tactics that they can be predicted to use against DoD assets. These aggressor tactics and their associated tools, weapons, explosives, and agents are the basis for the threat to assets. Understanding the basis for the threat and the aggressors' objectives is essential to effective protective system design. This chapter describes aggressors, tactics, tools, weapons, explosives, and agents that are referred to throughout the security engineering series of UFC.

For the purposes of designing a protective system, the perpetrators of terrorist or criminal acts or acts of espionage are not important. To designers the important issue is how an aggressor attacks the asset and with what. Within this UFC aggressors will only be considered in determining the tactics that will be used against assets and the tools, weapons, explosives, and agents associated with those tactics. The aggressors will not be carried into the design criteria.

This is by no means a comprehensive treatment of threat. The purpose of this chapter is to provide a common basis for defining threat for the purposes of facility design. Planning teams may add additional threat parameters as they find it necessary.

2-2 **AGGRESSORS.** Aggressors are people who perform hostile acts against assets such as equipment, personnel, and operations. The aggressor objectives and aggressor categories considered in this UFC are described below.

2-2.1 **Aggressor Objectives.** There are four major aggressor objectives that describe aggressor behavior. An explanation of how these objectives apply to each aggressor category is presented in subsequent paragraphs. Aggressors may use the first three objectives to accomplish the fourth. The four aggressor objectives include:

- Inflicting injury or death on people
- Destroying or damaging facilities, property, equipment, or resources
- Stealing equipment, materiel, or information
- Creating adverse publicity

2-2.2 **Aggressor Categories.** The four broad categories of aggressors considered in this manual are criminals, protesters, terrorists, and subversives. Hostile acts performed by these aggressors range from crimes such as burglary to low-intensity conflict such as unconventional warfare. Each of these aggressor categories describes predictable aggressors that pose threats to DoD assets and who share common objectives and tactics. This manual does not address the commonly referenced

aggressor category of disaffected persons, which includes disoriented persons and disgruntled employees. Those aggressors are not covered separately in this manual because they may exhibit similar characteristics to any of the four categories included or they generally do not present a predictable threat.

2-2.2.1 **Criminals.** Criminals are divided into one of three possible groups based on their degree of sophistication. These three groups are defined as unsophisticated criminals, sophisticated criminals, and organized criminal groups. The common objective for all three criminal groups is assumed to be theft of assets.

2-2.2.1.1 **Unsophisticated Criminals.** Unsophisticated criminals are unskilled in the use of tools and weapons and have no formal organization. Their targets are those that meet their immediate needs such as drugs, money, and pilferable items. Unsophisticated criminals are interested in opportune targets that present little or no risk. Breaking and entering or smash-and-grab techniques are common. Theft by insiders is also common.

2-2.2.1.2 **Sophisticated Criminals.** Sophisticated criminals are skilled in the use of certain tools and weapons and are efficient and organized. They plan their attacks and have sophisticated equipment and the technical capability to employ it. Sophisticated criminals are often assisted by insiders. They target high value assets, frequently steal in large quantities, yet target assets with relatively low risk in handling and disposal. Commonly targeted facilities include controlled substance (drug) storage, warehouses, post exchanges, and Class VI (liquor) stores.

2-2.2.1.3 **Organized Criminal Groups.** Organized criminal groups are highly sophisticated, are able to draw on specialists, and are able to obtain the equipment needed to achieve their goals efficiently. These groups form efficient, hierarchical organizations which can employ highly paid insiders. Examples include drug cartels, organized crime "families," the Yakuza, and MS-13. Targets of organized criminal groups may involve a high degree of risk in handling and disposal such as large quantities of money; equipment; and arms, ammunition, and explosives. In addition, some such organizations have exhibited the will to inflict death or injury to support their activities or intimidate law enforcement personnel.

2-2.2.2 **Protesters.** For the purposes of this manual, only violent protesters are considered to be a threat. Protesters include the two general groups of vandals/activists and extremist protesters. Both groups are politically or issue oriented and act out of frustration, discontent, or anger against the actions of other social or political groups. The primary objectives of both groups commonly include destruction and publicity.

2-2.2.2.1 **Vandals/Activists.** Vandals/activists are commonly unsophisticated and superficially destructive. They generally do not intend to injure people or cause extensive damage to their targets. Their actions may be covert or overt. Typically, they choose symbolic targets that pose little risk to them. For the purposes of risk analysis in this document, vandals/activists are grouped with criminals.

2-2.2.2.2 **Extremist Protest Groups.** Extremist protest groups are moderately sophisticated and are usually more destructive than vandals. Their actions are frequently overt and may involve the additional objective or consequence of injuring people. They attack symbolic targets, including authority figures such as high-ranking officials and police, weapon systems, and things they consider to be environmentally unsound. For the purposes of risk analysis in this document, extremist protest groups are grouped with terrorists.

2-2.2.3 **Terrorists.** Terrorists are ideologically, politically, or issue oriented. They commonly work in small, well-organized groups or cells. They are sophisticated, skilled with tools and weapons, and possess an efficient planning capability. Terrorist objectives usually include death, destruction, theft, and publicity. Three types of terrorist groups are identified in this manual based on their areas of operation and their sophistication. The three types are domestic terrorists, international terrorists, and state sponsored terrorists.

2-2.2.3.1 **Domestic Terrorists.** Domestic terrorists for the purposes of this UFC are terrorists indigenous to the United States, Puerto Rico, and the US territories who are not directed by foreign interests. Domestic terrorists in the United States have typically been political extremists operating in distinct areas of the country. They have primarily consisted of ethnic and white supremacy groups, many with ties to groups that originated during the 1960's and 1970's. Historically, most acts of terrorism in the United States by domestic terrorists have been less severe than those outside the United States, and operations have been somewhat limited. One noted exception to that trend was the bombing of the Alfred P. Murrah Building in Oklahoma City.

2-2.2.3.2 **International Terrorists.** International terrorists are either connected to a foreign power or their activities transcend national boundaries. International terrorists have typically been better organized and better equipped than their domestic counterparts. They have included political extremists and ethnically or religiously oriented groups. Their attacks have also been more severe and more frequent than those by domestic terrorists in the United States. Examples of foreign terrorist groups designated by the U.S. Department of State include the Revolutionary Group 17 November, the Aum Shinrikyo Group, Basque Fatherland and Liberty (ETA), Sendero Luminoso (Shining Path), and the al-Aqsa Martyrs Brigade.

2-2.2.3.3 **State Sponsored Terrorists.** State sponsored terrorist groups generally operate independently, but receive foreign government support, to include intelligence and even operational support. They have exhibited military capabilities and have used a broad range of military and improvised weapons. They have historically staged the most serious terrorist attacks, including suicidal attacks. They are predominantly ethnically or religiously oriented. Some of these groups have legitimate political wings in addition to their terrorist wings. Examples of state sponsored terrorist groups designated by the U.S. Department of State include al Qaida, the Palestinian Islamic Jihad, Hizballah, and the Revolutionary Armed Forces of Columbia (FARC).

2-2.2.4 **Subversives.** Subversives include aggressors from foreign governments or from groups trying to overthrow the government by force. They include saboteurs and foreign intelligence agents.

2-2.2.4.1 **Saboteurs.** Saboteurs include guerrillas and unconventional warfare forces. They are paramilitary or actual military personnel who are very sophisticated, highly skilled, and employ meticulous planning. They commonly act in small groups, have an unlimited arsenal of weapons, and are well-trained in the use of those weapons. The objectives of saboteurs usually include destruction of property and death and their targets include mission-critical personnel, equipment, and operations. The scope of this manual is limited to sabotage in a low intensity conflict; therefore, full-scale attacks by guerrillas or commandos during wartime are not addressed.

2-2.2.4.2 **Foreign Intelligence Agents.** Foreign intelligence agents are highly skilled and very sophisticated. They are generally foreign agents, but they frequently employ insiders for assistance. These agents commonly operate covertly to avoid detection before, during, or after an action. Their objective is usually assumed to be theft of sensitive information.

2-3 **AGGRESSOR TACTICS.** Aggressors have historically employed a wide range of offensive strategies reflecting their capabilities and objectives. This UFC and subsequent UFCs in the security engineering series categorize these offensive strategies into 13 tactics that are specific methods of achieving aggressor goals. Separating these tactics into categories allows facility planners to define threats in common terms that can be used by facility designers.

2-3.1 **Moving Vehicle Bomb Tactic.** In this tactic aggressors drive an explosives-laden car or truck into a facility and detonate the explosives. The aggressors' goals are to damage or destroy the facility and/or to kill people. This is a suicide attack.

2-3.2 **Stationary Vehicle Bomb Tactic.** In this tactic aggressors covertly park an explosives-laden car or truck near a facility. It is assumed that the aggressors park the vehicle in a legal location to avoid being noticed. The aggressors then detonate the explosives either by time delay or remote control. The aggressors' goals in this tactic are the same as for the moving vehicle bomb tactic with the additional goal of destroying assets within the blast area.

2-3.3 **Hand Delivered Device Tactic.** In this tactic aggressors attempt to enter a facility or get close to the exterior of a facility or to assets not located within a facility with either placed or thrown explosives or incendiary devices. This tactic also includes explosive or incendiary devices delivered through the mail or to supply and materiel handling points such as loading docks. The aggressors' goals are to damage the facility, to injure or kill its occupants, or to damage or destroy assets.

2-3.4 **Indirect Fire Weapons Tactic.** In this tactic aggressors fire military or improvised indirect fire weapons at a facility from a significant distance. Indirect fire weapons (commonly mortars or rockets) do not require a clear line of sight to the target. They can be fired over obstacles. The aggressors' goals are to damage the facility, to injure or kill its occupants, or to damage or destroy assets.

2-3.5 **Direct Fire Weapons Tactic.** In this tactic aggressors fire weapons that require direct lines of sight to targets. These attacks may be from a significant distance or may be close-up as in a drive-by shooting. Direct fire weapons include antitank weapons and various small arms, such as pistols, submachine guns, shotguns, and rifles. The aggressors' goals are to injure or kill facility occupants or to damage or destroy assets.

2-3.6 **Forced Entry Tactic.** In this tactic aggressors forcibly enter a facility using forced entry tools, explosives, and small arms. The aggressor uses the tools and explosives to create a man-passable opening or to operate an operable assembly in the facility's walls, doors, roof, windows, or utility openings. The aggressor may also use explosives or small arms to overpower guards as part of this tactic. The aggressors' goals are to steal or destroy assets, compromise information, injure or kill facility occupants, or disrupt operations.

2-3.7 **Covert Entry Tactic.** In this tactic aggressors attempt to enter a facility or portion of a facility to which they do not have authorized access by using false credentials, by stealth, and by surreptitious entry. Covert entry can either be by people not associated with a facility or insiders who try to access areas in which they are not authorized. The aggressors' goals are to steal assets, to compromise information, to disrupt operations, or to injure or kill building occupants.

2-3.8 **Visual Surveillance Tactic.** In this tactic aggressors employ ocular and photographic devices such as binoculars and cameras with telephoto lenses to monitor facility or installation operations or to see assets. The aggressors' goal is to compromise information. Aggressors may also use this tactic as a precursor to other tactics to determine information about an asset of interest or about security measures.

2-3.9 **Acoustic Eavesdropping Tactic.** In this tactic aggressors employ listening devices from outside a facility or restricted area of a facility to monitor voice communication or other audibly transmitted information. This tactic does not include the use of listening devices "planted" inside facilities. Those devices are in the realm of technical security and are beyond the scope of this manual. The aggressors' goal in this tactic is to compromise information.

2-3.10 **Electronic Emanations Eavesdropping Tactic.** In this tactic aggressors employ electronic emanation surveillance equipment from outside a facility or restricted area of a facility to intercept electronic emanations from computers, communications, and related equipment. This tactic is commonly treated in the context of TEMPEST protection, most of the details of which are classified. There are, however, unclassified

facility design related issues that will be described in the security engineering series of UFCs. The aggressors' goal in this tactic is to compromise information.

2-3.11 **Airborne Contamination Tactic.** In this tactic aggressors contaminate the air supply of a facility by introducing chemical, biological, or radiological agents into it. These agents can be delivered to facilities either by external or internal release. External release can be from directed plumes spread from a standoff distance, from a point or line source, from general aerial release, or by directly inserting them into outside air intakes. Internal release can be through the mail, by supplies delivery, direct release within the building area, or insertion into the building ventilation system. The aggressors' goal is to kill or injure people.

2-3.12 **Waterborne Contamination Tactic.** In this tactic aggressors contaminate the water supply to a facility by introducing chemical, biological, or radiological agents into it. These agents can be introduced into the system at any location with varying effectiveness depending on the quantity of water and the contaminant involved. The aggressors' goal is to kill or injure people.

2-3.13 **Waterfront Attacks.** In this tactic aggressors attack people or other waterfront assets from the water either by swimming or on watercraft. Attacks on waterfront assets from the land are covered by other tactics. The aggressors' goal is to kill or injure people or to damage or destroy equipment or other assets.

2-3.14 **Tactics Not Addressed.** This UFC and the security engineering series of UFCs address the typical threats to fixed facilities for which designers can provide protective measures. Some common terrorist tactics are beyond the protection facility designers can provide. Kidnappings, hijackings, and assassinations that take place away from facilities or during travel between facilities are beyond the designers' control. Protection against those threats is provided through operational security and other means not associated with facility design. This UFC does not address such tactics or postulated tactics that have minimal historical or intelligence basis among the aggressors addressed in this UFC such as airborne bombings or airborne attacks using light or remote-controlled aircraft. While attacks like the aircraft attack on the World Trade Center have precedent, they are not addressed in this UFC because it is impractical to design conventional facilities to resist them. The use of nuclear devices is not addressed for the same reason.

2-4 **TOOLS, WEAPONS, EXPLOSIVES, AND AGENTS.** Aggressors use various tools, weapons, explosives, and agents to attain their objectives. The tools, weapons, explosives, and agents included in this UFC and discussed throughout the security engineering series of UFCs represent those used currently and historically or those that can be reasonably expected in the near future. Specific tools, weapons, explosives, and agents associated with each tactic are identified in chapter 3 of this UFC. General descriptions of these tools, weapons, explosives, and agents are provided below.

2-4.1 **Tools.** Tools used to breach protective construction components or barriers include forced entry tools, vehicles, and surveillance tools. Credentials used to gain access to an asset can also be considered tools.

2-4.1.1 **Forced Entry Tools.** These tools include hand, power, and thermal tools and explosives that can be carried by two people. In this manual, forced entry tools are divided into the following categories based on increasing levels of sophistication, skill required to use the tools, and risk of detection associated with use of the tools (referred to as observability).

2-4.1.1.1 **Limited Hand Tools.** Limited hand tools are those hand tools that have low observability. They include claw tools, carpenter's saws, hacksaws, Kelly tools, bolt cutters, pliers, spanner wrenches, tin snips, wrecking and pry bars, and wire cutters. These kinds of tools can be found in homes and small workshops and require little skill or sophistication to use.

2-4.1.1.2 **Unlimited Hand Tools.** These tools include the limited hand tools listed above plus high observable tools such as hammers, sledgehammers, cutting mauls, shovels, pry axes, pick head axes, and fire axes. These include tools that are not as commonly available such as those that are used by firefighters.

2-4.1.1.3 **Power Tools.** Power tools are categorized a limited or unlimited. Unlimited power tools include electric (with external power), gasoline, or air-powered circular saws, reciprocating saws; chain saws; saber saws; roto-hammers (rotating jackhammers) and drills. Limited power tools can be the same as unlimited (circular and reciprocating saws, etc.), but the power source is self-contained (batteries). Hydraulic bolt cutters and rescue tools are also included in the limited tool category.

2-4.1.1.4 **Thermal Tools.** Thermal tools include oxyacetylene, electric arc, or oxygen fed cutting torches, burn bars, and rocket torches. Burn bars are pipes containing steel rods and an oxygen supply tube. They emit a stream of extremely hot flame capable of burning through thick steel plate and concrete.

2-4.1.1.5 **Explosives.** Explosives used as forced entry tools include bulk or equivalent tamped explosive breaching charges and linear shape charges. Breaching charges are quantities of explosives placed directly against an object the aggressor intends to breach or destroy. Such charges can be backed up with a mass such as a steel plate or soil to direct their explosive effects. This practice is referred to as tamping the charge. Linear shape charges are explosives that are manufactured in strips and formed into shapes that direct the force of the explosives into a narrow area directly underneath the strip. They are used to cut man-passable openings through materials.

2-4.1.2 **Vehicles.** Used as tools, vehicles breach layers of defense or barriers and may carry explosives. The vehicles considered in this UFC include cargo trucks ranging from 7000 to 18000 kilograms (approximately 15,000 to 40,000 pounds) gross vehicle weight, small trucks up to 2500 kilograms (approximately 5,500 pounds) gross

vehicle weight, and cars up to 1800 kilograms (approximately 4,000 pounds) gross vehicle weight.

2-4.1.3 **Watercraft.** Used as tools, watercraft can breach defined perimeters associated with waterfronts. Watercraft considered in this UFC include small powerboats, Combat Rubber Raiding Craft, Rigid Hulled Inflatable Boats, jet skis, swimmer delivery vehicles, and torpedoes.

2-4.1.4 **Surveillance Tools.** Surveillance tools enable aggressors to gather information from a distance. The various types of these tools are described below.

2-4.1.4.1 **Ocular Devices.** These enhance vision for visual surveillance. Ocular devices include binoculars, telescopes, cameras, and night vision devices.

2-4.1.4.2 **Listening Devices.** These include devices that amplify audible communication signals such as speech. They include directional microphones and laser operated listening devices. For the purposes of this UFC, they do not include electronic microphones (bugs) hidden in a facility. Those devices are covered in the area of technical security, which is beyond the scope of this UFC and generally beyond the scope of facility design.

2-4.1.4.3 **Electronic Emanations Eavesdropping Equipment.** This equipment includes devices that intercept and translate emanations from electronic equipment. This equipment is generally described in the context of the TEMPEST threat, most of the details of which are classified.

2-4.1.5 **False Credentials.** False credentials include any form of authorization or identification credential that can be falsified or counterfeited and used by unauthorized personnel or otherwise misused. These include, but are not limited to, keys, key cards, badges, and identification or authorization documents. False credentials are used in the covert entry tactic.

2-4.2 **Weapons.** Aggressors kill or injure people or damage or destroy facilities or assets using weapons that range from incendiary devices to mortars. Categories of weapons and their uses are described below.

2-4.2.1 **Incendiary Devices.** These devices include a wide range of devices that can be used to spread fire, most of which are improvised. A prime example of an improvised incendiary device (IID) is a Molotov cocktail, which is a bottle of flammable liquid with a rag in the top. After the rag is lit, the bottle is thrown, it breaks on the surface it hits, the flammable liquid catches fire, and the fire spreads over whatever it hits. Incendiary devices may be used to attack the exterior of a facility or to sabotage an asset.

2-4.2.2 **Direct Fire Weapons.** Direct fire weapons must be aimed directly at a target and the line of sight to the target must be clear to successfully hit it. There is a

broad range of indirect fire weapons, but for the purposes of this UFC, they will be limited to small arms and anti-tank weapons.

2-4.2.2.1 **Small Arms.** Small arms include pistols, rifles, shotguns, and submachine guns that can be either military issue or civilian weapons. The weapons are described in this UFC in terms of ballistics standards developed for testing the resistance of building elements or assemblies to the weapons' effects. These standards generally indicate the weapon to be used in the test, the ammunition, the muzzle velocity, and the number of rounds to be fired. Aggressors use small arms to attack assets from a distance and may also use them to overpower guards. They are not used to shoot off locks or similarly breach construction components.

2-4.2.2.2 **Antitank Weapons.** Antitank weapons are fired from a distance and may be directed against facilities, vehicles, or other assets that could be targeted from a distance. The antitank weapons considered in this manual are shoulder-fired, rocket propelled grenade (RPG) launchers. Examples of weapons that have been used by terrorists include the Russian RPG-7, RPG 18, and RPG 22 and the U.S. M-72 Light Antitank Weapon (LAW). While there are more effective antitank weapons and missiles, only the class of such weapons stated above will be considered due to their wide availability and the history of their use. In addition, building conventional buildings to resist more effective weapons is impractical.

2-4.2.3 **Indirect Fire Weapons.** Indirect fire weapons are those that can be fired over obstacles to hit targets. They do not require a clear line of sight as direct fire weapons do, but they do require a clear line of flight. For the purposes of this UFC, indirect fire weapons will be considered to include mortars and small rockets. The small rockets considered here are improvised or military rockets with small explosive or incendiary charges on them, which are representative of historical terrorist attacks. The mortars considered in this UFC include both military and improvised mortars. Historically, the improvised versions of mortars have carried larger quantities of explosives than the military versions used by terrorists.

2-4.3 **Explosives.** Aggressors commonly use explosives to damage or destroy facilities or assets or to kill or injure people. Explosives used to force entry are described in the discussion on tools above. Explosives are particularly attractive to terrorists because bombs are inexpensive to build and provide a significant psychological and destructive impact. Explosives are measured according to their equivalence to a particular weight of TNT, which is referred to as TNT equivalence. The types of explosives covered in this UFC are described below.

2-4.3.1 **Improvised Explosive Devices (IED).** These are homemade bombs built of explosives such as plastic explosives or TNT. Plastic explosives are the explosive of choice for terrorists and extremist protesters because they are readily formable, stable, and difficult to detect.

2-4.3.2 **Hand Grenades.** These include common military issue antipersonnel and fragmentation hand grenades that consist of casings filled with explosives that may or may not include a fragmenting material.

2-4.3.3 **Vehicle Bombs.** These bombs contain large quantities of explosives delivered in various sizes of both land vehicles and watercraft. The explosives weight categories chosen for use in this manual are based on historical precedent and concealability and vary with vehicle size. One of the more common explosives used in these large bombs is ammonium nitrate fuel oil (ANFO), which can be made easily from fertilizer and fuel oil.

2-4.4 **Chemical, Biological, and Radiological Agents.** Chemical, biological, and radiological agents and industrial chemical and radiological agents can be categorized by physical state as liquids, solids (or particulates), and gases (or vapors). In addition, for the purposes of waterborne contaminants, they can be further categorized based on the duration of their stability in water and the ease with which they can be disinfected with chlorine or chloramine.

2-4.4.1 **Toxic Industrial Chemicals.** These are liquids and gases produced for commercial and industrial applications. They are generally of lower toxicity than the military nerve agents but are available throughout the world. An industrial task force identified a list of 98 of these chemicals as presenting particular threat because of their toxicity and availability. In the Final Report of Task Force 25, Hazard from Industrial Chemicals, Facilities may be vulnerable to an accidental or terrorist caused release of toxic industrial chemicals from nearby manufacturing or storage facilities. Industrial chemicals can also be released from accidents or sabotage involving trucks or train cars carrying toxic industrial chemicals traveling near the facility.

2-4.4.2 **Military Chemical Agents.** Military chemical agents are described in U.S. Army Field Manual 3-9, Navy Publication P-467, and Air Force Manual 355-7. They can be liquid, gas, or aerosol at standard conditions. Most of the toxic military agents are liquids, which evaporate at differing rates to produce vapor. Chemical agents produce casualties through inhalation or contact with the skin or eyes.

2-4.4.3 **Biological Agents.** Biological agents are small particles of biological material, generally in the size range of 1 to 5 microns if they are to be delivered effectively as aerosols. Toxins, which are agents of biological origin, may be in liquid or crystalline form. Many of these agents can be cultured in unsophisticated laboratories using commercially available equipment. For descriptions of biological agents, refer to Army Field Manual 3-6, Marine Corps Publication FMFM 7-11-H, or Air Force Manual 105-7.

2-4.4.4 **Radiological Agents.** Terrorists could possibly build and detonate a nuclear weapon, but the intentional spread of radioactive isotopes or radioactive waste is much more likely. A potential means to spread radioactive materials is by incorporating radiological materials into a bomb made with a conventional explosive and letting the explosion disperse the radiological material. That kind of device is commonly

referred to as a “dirty bomb.” Radioactivity can persist for years. Radioactivity is unaffected by chemical reactions, so it cannot be neutralized. Radioactive waste is typically disposed of by dilution of concentration. Concentration and storage at a disposal site is necessary for high-level (very radioactive) waste. For descriptions of radiological agents, refer to Army Field Manual 3-6, Marine Corps Publication FMFM 7-11-H, or Air Force Manual 105-7.

This page intentionally left blank

CHAPTER 3

DESIGN CRITERIA DEVELOPMENT

3-1 **INTRODUCTION.** This chapter presents a procedure for developing design criteria for a facility as illustrated in Figure 3-1 below. The procedure is designed to capture and apply the inputs of the diverse members of a Planning Team as described in Chapter 1. The procedure includes the development of preliminary design criteria based on consideration of the assets associated with a facility in terms of their value to their users and the likelihoods that different aggressors will target them. The preliminary design criteria are then evaluated using a preliminary risk analysis. The Planning Team may then adjust the preliminary design criteria to reflect the risk analysis or the cost necessary to implement the design criteria. The Planning Team may also adjust the criteria as necessary according to the professional judgments of the members of the team based on local and regional considerations. The resulting design criteria will be the basis for planning and preliminary design. It may be further adjusted during the design process based on the more detailed risk analysis process in UFC 4-020-02.

Figure 3-1. Design Criteria

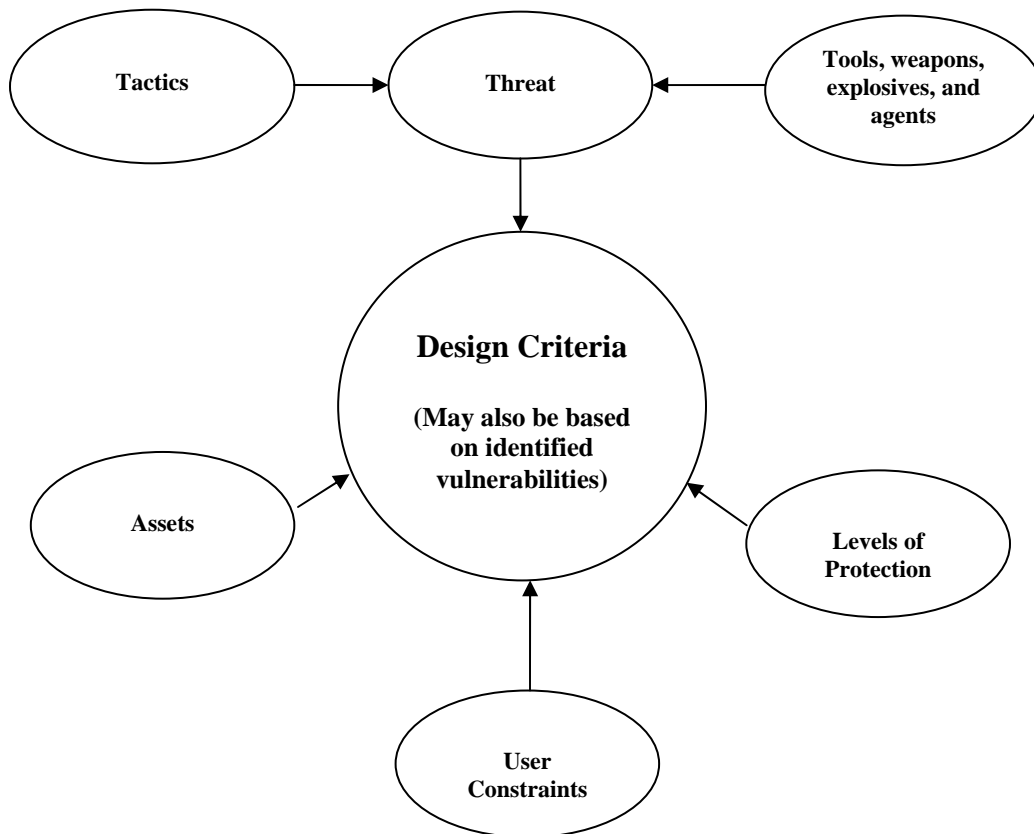

3-1.1 **Design Criteria.** Design criteria are the basis for defining a protective system that mitigates vulnerabilities to assets. The criteria describe the assets associated with a facility, the threat to those assets, the level to which those assets are to be protected against the threat, and any constraints to the protective system design that may be imposed by the Planning Team. For existing facilities, vulnerabilities are additional factors in establishing the design criteria. Those vulnerabilities will be based on evaluating how existing conditions affect the protection of the identified assets against the identified threats to the applicable levels of protection. Figure 3-1 shows the components of the protective system criteria. Including security requirements with project criteria allows security to be addressed at the start of the project and to be integrated into the total design efficiently and cost-effectively. In the absence of any other standards, the process in this chapter should be used to establish facility design criteria for security and antiterrorism related issues.

3-1.2 **Other Standards.** This UFC is designed to provide guidance for determining if design criteria beyond those established in various minimum standards, such as the DoD Minimum Antiterrorism Standards for Buildings, are necessary or justifiable. In addition, where design criteria are established as part of minimum standards or Operations Orders issued by various Combatant Commanders, those threats should be considered to override threats established through the procedure in this manual where there is any conflict or where the Combatant Command standards are more stringent. In addition, any applicable regulations or other Service guidance needs to be incorporated into designs.

3-1.3 **Priority.** Security requirements comprise only one component of a project criteria package and receive different emphasis depending upon their priority in a project. For example, if a facility is intended to provide maximum protection for an asset, security may receive top priority. This may necessitate modifications to other previously established criteria. The Planning Team must consider how security fits into the total project design and give it appropriate emphasis.

3-1.4 **Risk Management.** Risk management can be defined for the purposes of security engineering as evaluating alternative countermeasures and design requirements and selecting among them based on their effectiveness in mitigating threats and on their costs. This involves consideration of political, social, economic, and engineering information in conjunction with risk-related information to develop, analyze, and compare acceptable options and to select the appropriate response to a potential threat. The selection process requires placing values on such issues as the acceptability of risk, the reduction in risk due to applied countermeasures, and the reasonableness of the costs of the countermeasures.

3-1.4.1 **Risk Analysis.** There are many ways to evaluate risk. Most are very rigorous and require a definitive database of frequency of events as well as detailed information on consequences and vulnerabilities. There is not yet a good enough database of terrorist, criminal, and other aggressors' acts against DoD or Government assets to provide the basis for a realistic statistical distribution to predict such events. Aggressor acts against DoD and Government assets are so uncommon as to be

statistically insignificant. That does not, however, mean we should be complacent because we know that such acts can occur at any time in any place. Evaluating risk, therefore, is necessary, but it requires a “relative” approach. The procedure in this chapter represents such an approach.

3-1.4.2 Risk Analysis Procedure. The procedure in this UFC evaluates risk based on likelihood of attack, the consequences of that attack, and the effectiveness of applied countermeasures in mitigating any attack. The latter is inversely related to vulnerability. Highly effective countermeasures commonly reflect lower vulnerability. The procedure is based on a subjective approach to determining design criteria and on a relative approach to evaluating vulnerabilities. The procedure also allows for quantification of risk acceptance by comparing the costs associated with changes in relative risk. The basic risk equation used in this procedure is the product of asset value, threat likelihood, and a measure of the effectiveness of protection. It will be described in detail later in the chapter. Risk analysis for the purposes of design criteria development and planning is predicated on simplifying assumptions regarding countermeasures. More detailed treatment of the contributions of individual countermeasures to risk is covered in UFC 4-020-02.

3-1.4.3 Background. In developing this procedure several other established procedures were considered. They included the procedure in the Joint Antiterrorism Guide, the procedure in Army Technical Manual 5-853-1/Air Force Manual AFMAN 32-1071, Volume 1 and Department of the Army Pamphlet 190-51, the CARVER process, the DSHARPP process, the MSHARPP process, and the Naval Facilities Engineering Service Center’s Risk Analysis Vulnerability Assessment (RAVA) process. In addition, processes in use by other agencies of the U.S. Government and private sector processes were evaluated. None of those processes were found to address all the needs of this UFC; therefore, the process in this document was developed. There were many elements of the other processes that were very useful, however. Those elements were incorporated into this process to the greatest extent possible. Detailed discussions on MSHARPP and CARVER can be found in DoD O-2000.12-H.

3-2 USING THIS PROCEDURE. The design criteria development procedure in this chapter comprises ten steps. The ten steps address the identification of the elements of design criteria and the adjustment of them through preliminary risk analysis. The procedure is summarized in the flow chart in Figure 3-2. The procedure uses worksheets to guide the Planning Team through the series of decisions necessary to identify the applicable assets, threats, and levels of protection. The decisions are based on a series of subjective questions that may lead the Planning Team to an objective answer in a manner that is reproducible among different Planning Teams and over time. The preliminary design criteria thereby developed may be adjusted through a common means of risk analysis. The ten steps in the design criteria development procedure are described separately below. In addition to the basic principles associated with each step, each of the applicable tables associated with that step is described and guidance is provided on their application.

Figure 3-2. The Design Criteria Development Procedure

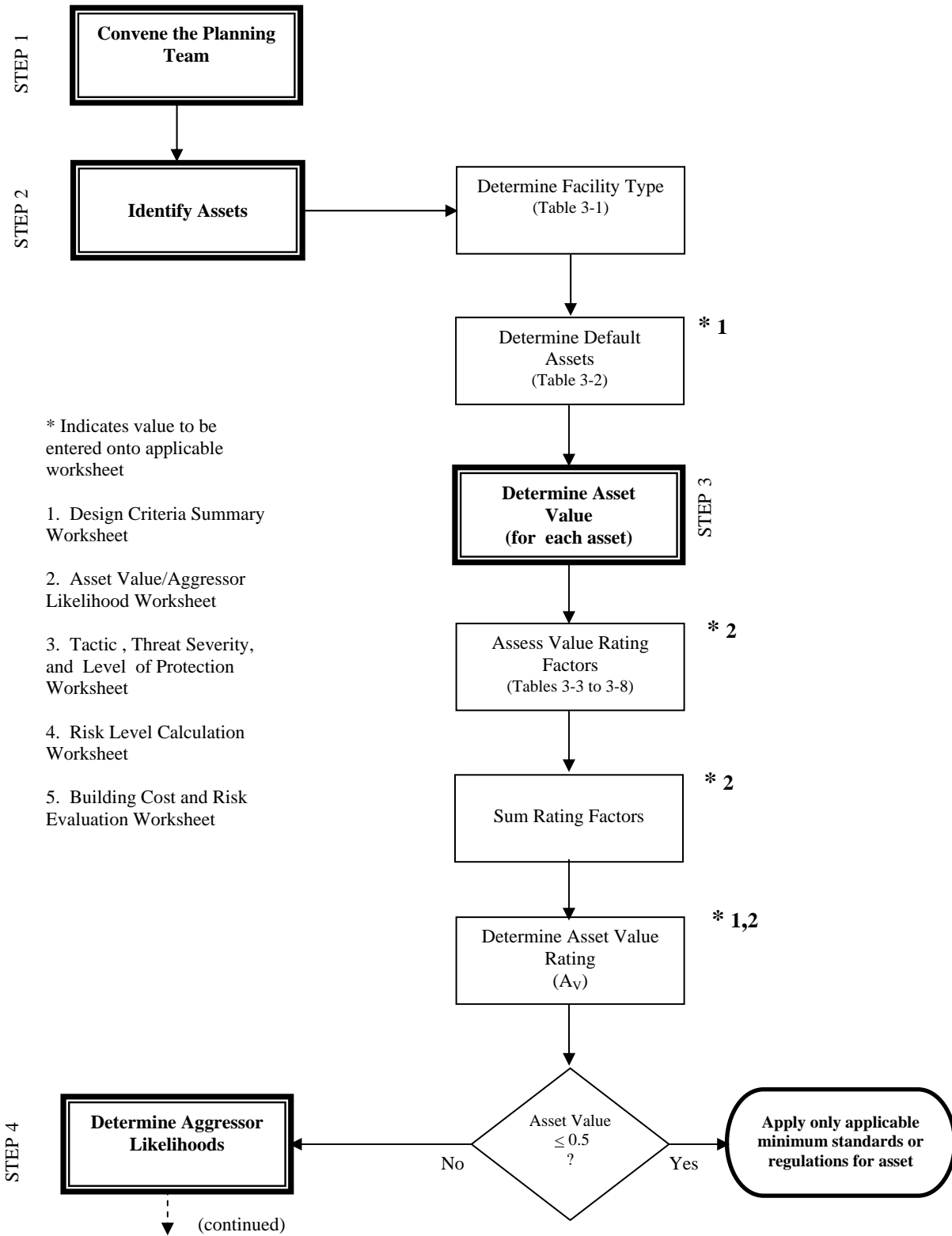

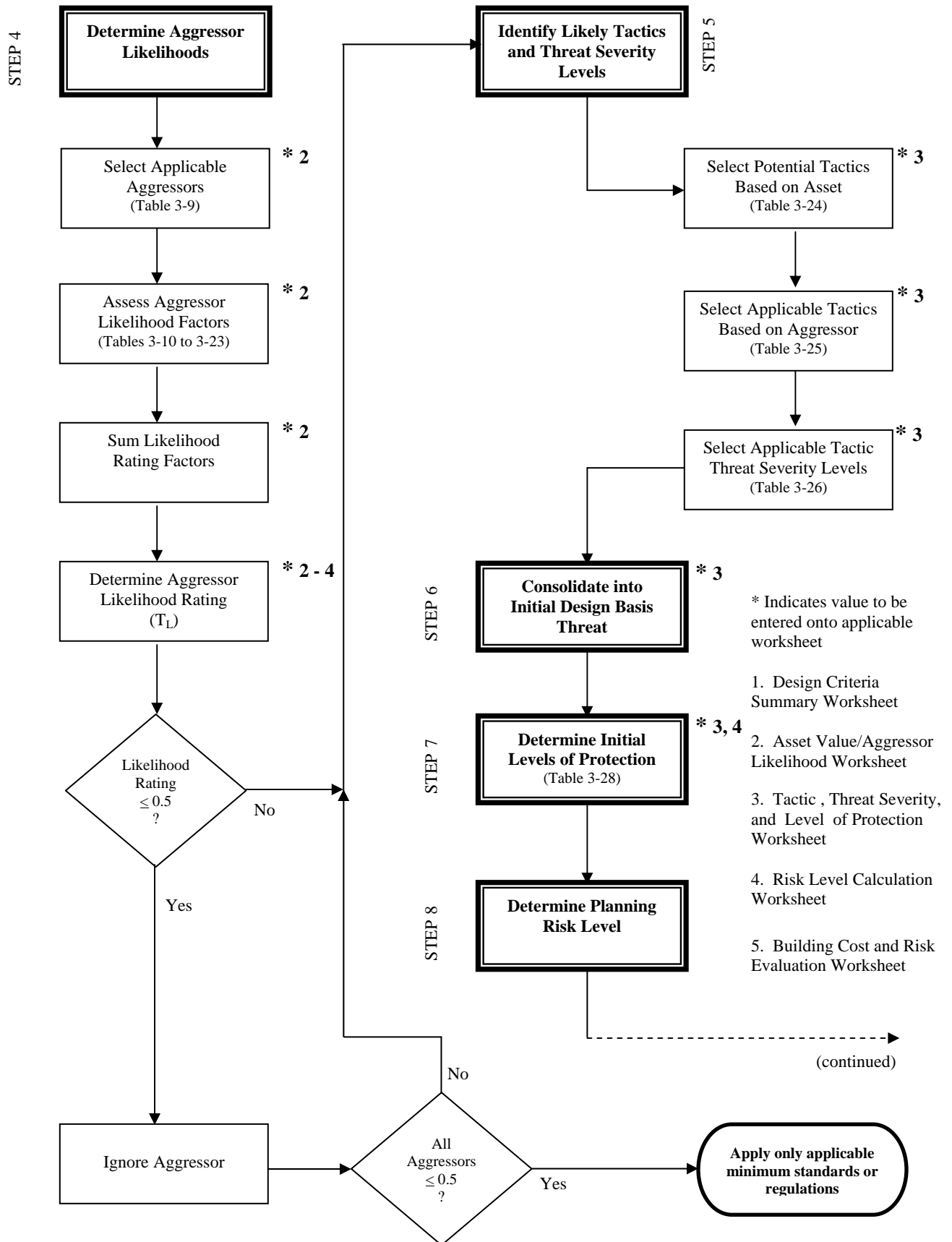

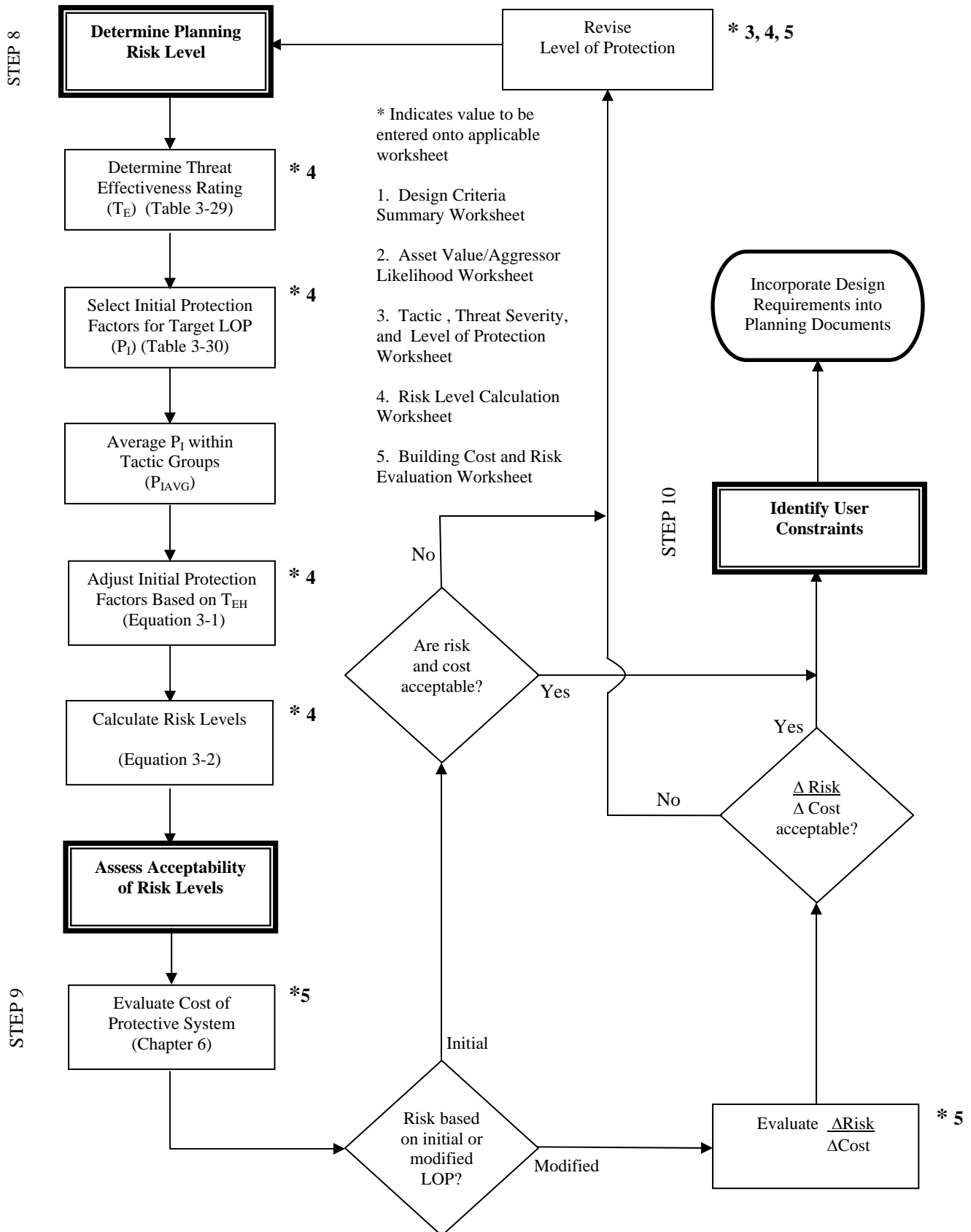

3-3 **STEP 1: CONVENE THE PLANNING TEAM.** The first step of the process of developing design criteria is to convene the Planning Team as described in Chapter 1. It is essential to the effectiveness of the design criteria development to have an interdisciplinary team involved in the process. All the members of that team have unique perspectives that need to be reflected in the effort. The team should be convened at the inception of project planning and should provide review and oversight at all stages of project development. It should also be consulted during the design process as described in UFC 4-020-02.

3-4 **STEP 2: IDENTIFY ASSETS.** The design criteria developed in this chapter relate primarily to assets associated with facilities as opposed to the facilities themselves. Protecting individual assets is generally more cost effective than protecting an entire facility. Buildings should only be considered assets if they are the likely direct target of aggression, as in vandalism or where the buildings have some special significance such as a highly symbolic or historic structure. Determining the assets to be protected is the first step in establishing any protective system. The following two steps are provided to facilitate a degree of consistency in identifying DoD assets.

3-4.1 **Determine Facility Types.** There are many types of facilities on military installations or used by the military off installations. For the purposes of easily identifying assets in a consistent manner, those facilities have been divided into 22 broad categories. Those categories are tabulated in Table 3-1, which also includes common examples of each of those facility types. Table 3-1 also includes the baseline building categories that are referred to in Chapter 4 and that are used in determining costs for the protective systems necessary to implement the design criteria developed using this process. Determine which of the facility types from the center column of Table 3-1 applies to the facility being analyzed.

3-4.2 **Determine Default Assets.** There are an almost unlimited number of different kinds of assets likely to be found in DoD facilities. Those assets may be grouped into categories to effectively deal with them. Table 3-2 includes a list of generic asset categories into which assets can be grouped. These categories include the assets that are commonly targeted by aggressors and which are frequently of significant value to their users. These categories also include assets that are required to be protected by regulation. They do not, however, include nuclear weapons or materials or chemical weapons because those assets have very strict regulations for their protection that are well established and generally more stringent than the countermeasures reflected in this manual.

The asset categories in Table 3-2 are assigned letters for ease of use. Those letters should not be interpreted to represent priorities. The assets that are likely to be present in various facility types are predictable, and can therefore be tabulated on a default basis. Table 3-2 provides a default list of asset types that may be expected to be found in the common facility types listed in Table 3-1.

Use Table 3-2 to identify default assets associated with the applicable facility type, and then adjust that list based on which of those assets are actually

present in the facility. Also identify any other assets within a facility or associated with a project that are of value to the user based on their importance to the user's mission or on some other measure of value such as monetary worth. In addition, identify any additional assets that are to be protected based on policies, command directives, or regulations, and identify people who will be considered assets based on one or more of the above considerations. In the case of people, the Planning Team will have to determine whether they are mission critical people or the general population. The assets established in this step are the assets that the Planning Team should consider in the remainder of this procedure. Enter the identified assets and their applicable asset categories into the appropriate columns of the Design Criteria Summary Worksheet as illustrated in Figure 3-3.

Table 3-1. Common Facility Types

Baseline Building Category	Facility Type	Examples
Administrative and Community Support Buildings *	Headquarters and Operations Facilities and Other Administrative Facilities	Brigade, Battalion, Company Headquarters
		Airfield Operations Facility
		Aviation Unit Operations Facility
		Field Operations Facility
		Ship Operations Facility
		Emergency Operations Facility
		Fire / Police Station
		National Guard / Reserve Centers
		Cargo Handling Office
		Dispatch Building
		Courtroom
	General Administrative Facility	
	Schools and Education Facilities	Education Center
		Dependent School
		Religious Education Center
	Community Facilities	Community Service Center
Child Development Center		
Drug / Alcohol Abuse Center		
Red Cross Building		
Craft Centers		
Small Retail Facilities	Shoppette	
	Golf Clubhouse	
	Laundry	
	Video Rental Store	
Unaccompanied Personnel Housing *	Unaccompanied Personnel Housing	Enlisted Barracks / Dormitories
		Trainee Barracks / Dormitories
		Transient Unaccompanied Personnel Housing
		Unaccompanied Officers / Enlisted Personnel Housing
Family Housing	Family Housing	Family Housing Units
Dining Facilities *	Dining Facilities	Dining Facilities
		EM Club

(Table 3-1 continued)

Medical Facilities *	Medical Facilities	Hospital
		Medical Clinic
		Dental Clinic
		Pharmacy
		Veterinary Clinic
		Laboratory
Special Structures *	Religious Facilities	Chapel
	Recreation Facilities	Auditorium
		Gymnasium
		Bowling Alley
		Theater
	Commissaries and Exchanges	Commissary
		Exchange
		Alert Systems, Forces, and Facilities
Maintenance Facilities (other than weapons)	Equipment Maintenance Facilities	Equipment Maintenance Facilities
	Aviation Maintenance Facilities	Aviation Maintenance Facilities
	Motor Pools	Motor Pools
	Aircraft Parking Areas - hangars	Aircraft Parking Areas
	Ship or Boat Berths	Ship or Boat Berths
	Arms, Ammunition, and Explosives Storage Facilities	Magazines
		Arms Rooms
		Weapons Maintenance Facilities
	Petroleum, Oils, and Lubricants Storage Facilities	Petroleum, Oils, and Lubricants Storage Facilities
	Research and Development Facilities	Research and Development Facilities
	Warehouses	Warehouses
	Utilities and Substations	Utilities and Substations
* Building types included in cost tables in Appendices A - C		

3-5 STEP 3: DETERMINE ASSET VALUE. Asset value refers to the value of an asset to its user. It is a reflection of the consequence of having the asset compromised by an aggressor. The asset value helps the Planning Team to determine the level of protection that is warranted for the asset.

3-5.1 Value Rating Factors. The value of an asset to its user is determined by evaluating up to five value rating factors, depending on the asset category. Those factors include mission criticality to the asset's user, impact on the national defense, replaceability, political sensitivity, and relative value. Not all factors are evaluated for general population, critical infrastructure, operations and activities, and sensitive information. Table 3-3 shows which factors are applicable to each asset category. The applicability of value rating factors is also indicated on the Asset Value/Aggressor Likelihood Worksheet. The factors are evaluated using tables in this chapter. These tables include statements that describe the value rating factors qualitatively. Select the statement from each table that most closely reflects the asset's value. Each statement has a numerical value associated with it that is used in determining the asset value rating. Where there is any question about the meaning of a specific statement in a table, consider all the statements in terms of "on a scale of 0 to 5." For each asset, enter the appropriate numerical value from each applicable value rating table in the spaces provided on the Asset Value/Aggressor Likelihood Worksheet. These will also

Facility Type	Asset Category																	
	A	B	C	D	E	F	G	H	I	J	K	L	M	N	O	P	Q	R
	People (mission critical and general population)	Aircraft and components at aviation facilities	Ships, boats, and other watercraft	Vehicles and carriage mounted or towed weapons systems & components	Petroleum, oils, and lubricants (POL)	Arms, ammunition, and explosives (AA&E)	Controlled medical substances	Communications/electronics test, measurement, & diagnostic equipment and tool kits and night vision devices	Organizational clothing and individual equipment	Subsistence items at commissaries, warehouses, & troop Issue facilities	Repair parts at installation supply and direct support units	Facilities engineering supplies and construction material	Audiovisual equipment, training devices, & subcaliber devices	Miscellaneous pilferable assets and currency or negotiable instruments	Critical infrastructure & industrial equipment	Controlled cryptographic items	Sensitive information	Activities and operations
Headquarters and Operations Facilities	✓					✓		✓					✓	✓	✓	✓	✓	✓
Other Administrative Facilities	✓					✓		✓					✓	✓	✓	✓	✓	✓
Unaccompanied Personnel Housing	✓					✓								✓	✓			
Dining Facilities	✓													✓	✓			
Family Housing	✓													✓	✓			
Hospitals	✓						✓							✓	✓			
Medical Clinics	✓						✓							✓	✓			
Schools and Education Facilities	✓												✓	✓	✓			
Religious Facilities	✓												✓	✓	✓			
Community Facilities	✓													✓	✓			
Commissaries and Exchanges	✓									✓				✓	✓			
Other Retail Facilities	✓													✓	✓			
Recreational Facilities	✓													✓	✓			
Alert Systems, Forces, and Facilities	✓	✓	✓	✓	✓	✓		✓							✓	✓	✓	✓
Maintenance Facilities	✓	✓	✓	✓	✓	✓		✓			✓			✓	✓			✓
Motor Pools		✓	✓	✓	✓	✓		✓						✓	✓			✓
Aircraft Parking Areas		✓	✓	✓	✓	✓		✓							✓			✓
Ship or Boat Berths		✓	✓	✓	✓	✓		✓							✓			✓
Arms, Ammunition, and Explosives Storage		✓	✓	✓	✓	✓									✓			✓
Petroleum, Oils, and Lubricants Storage		✓	✓	✓	✓	✓									✓			✓
Research and Development Facilities	✓							✓							✓		✓	✓
Warehouses		✓		✓	✓	✓	✓	✓	✓	✓	✓	✓		✓	✓	✓		
Utilities and Substations															✓			

Table 3-2. Default Assets

Figure 3-3. Sample Design Criteria Summary Worksheet

DESIGN CRITERIA SUMMARY WORKSHEET																										
Project or Building <i>A Motor Pool</i>			Analyst <i>Jane Q. Planner</i>		Date <i>4 August 2008</i>																					
Assets	Asset Category	Asset Value Rating	Explosive and Incendiary Devices						Standoff Weapons				Entry Tactics		Surveillance and Eavesdropping				Contamination Tactics		Waterfront Attack					
			Moving Vehicle Devices	Stationary Vehicle Devices	Hand Delivered Devices	Indirect Fire Weapons	Direct Fire Weapons	Forced Entry	Covert Entry	Visual Surveillance	Acoustic Eavesdropping	Electronic Emanations	Eavesdropping	Airborne Contamination	Waterborne Contamination											
			DBT	LOP	DBT	LOP	DBT	LOP	DBT	LOP	DBT	LOP	DBT	LOP	DBT	LOP	DBT	LOP	DBT	LOP	DBT	LOP	DBT	LOP		
<i>Tactical vehicles</i>	<i>D</i>	<i>.76</i>		<i>L</i>		<i>M</i>		<i>L</i>		<i>L</i>		<i>M</i>		<i>L</i>		<i>L</i>										

DBT = Design Basis Threat severity level LOP = Level of Protection

be entered on other worksheets for use in future steps of this process. The value rating factor tables and explanations for their application follow.

Table 3-3. Value Rating Factor Applicability

Asset Category	Value Rating Factor				
	Criticality to User / Population Type	Impact on National Defense	Replaceability	Political Sensitivity	Relative Value to User
General Population	✓			✓	✓
Critical Infrastructure and Operations and Activities	✓	✓	✓	✓	
Sensitive Information					✓
All Other Assets (including Mission Critical Personnel)	✓	✓	✓	✓	✓

3-5.1.1 **Criticality to User’s Mission / Population Type.** This factor addresses the criticality of the asset in its support of its user's mission and, in the case of the general population, whether they are military, DoD civilians, or dependents and other civilians. Criticality of mission critical personnel and property is measured in terms of the impact the person’s or asset’s loss would have on the user’s operations, output, production, or service. In the case of operations and activities, consider the impact of the activity’s or operation’s compromise. For the general population, because they are not mission critical, they are evaluated according to their status. The assumption therein is that the loss of military people is more readily accepted than the other types of personnel and the loss of DoD civilians is more accepted than dependents or other civilians. This factor is not evaluated for sensitive information. Evaluate this factor using Table 3-4.

Table 3-4. Criticality to User / Mission Impact/ Population Type

Asset Category	Population Type, Degradation Installation Mission, or Impact of Asset's Loss or Activity's Compromise on User's Mission	Value Rating Factor
General Population	Population is primarily military personnel	1
	Population is primarily DoD civilians and contractors	3
	Population is primarily dependents and other civilians	5
Critical Infrastructure	Loss would degrade or cause failure of specific functions, but have no effect on the installation-wide mission or missions of DoD facilities off installations	1
	Loss would cause failure of specific functions and minimally degrade the installation-wide mission or missions of DoD facilities off installations	2
	Loss would cause failure of specific functions and moderately degrade the installation-wide mission or missions of DoD facilities off installations	4
	Loss would cause installation-wide mission failure or failure of missions of DoD facilities off installations	5
All Other Assets (except for sensitive information) (including mission critical personnel, operations and activities, and critical industrial equipment)	Asset's loss or operation's /activity's compromise would have no significant effect on operations, output, production, or service	0
	Asset's loss or operation's /activity's compromise would result in halting operations within 1 month or would result in a 10% curtailment in output, production, or service	1
	Asset's loss or operation's /activity's compromise would result in halting operations within 2 weeks or would result in a 25% curtailment in output, production, or service	2
	Asset's loss or operation's /activity's compromise would result in halting operations within 1 week or would result in a 50% curtailment in output, production, or service	3
	Asset's loss or operation's /activity's compromise would result in halting operations within 1 day or would result in a 75% curtailment in output, production, or service	4
	Asset's loss or operation's /activity's compromise would immediately halt operations, output, production, or service. The user cannot function without it.	5

3-5.1.2 Impact on the National Defense. This factor addresses the criticality of the asset in its support of the defense of the United States and its interests. It accounts for the fact that some assets may be critical to their user's mission, but not to the broader national defense mission. An example of such an asset might be kitchen equipment in a community club. The equipment may be critical to the club's mission, but is unlikely to be critical to the war-fighting mission of the installation's tenant units. Considering this factor ensures that assets that are critical to military readiness receive a higher priority than those that are not. This factor is not evaluated for the general population or sensitive information. Evaluate this factor using Table 3-5.

Table 3-5. Impact on the National Defense

Impact of Asset's Loss on the National Defense	Value Rating Factor
The loss, theft, destruction, or misuse of the asset or operation's /activity's compromise could have insignificant impact on the United States or a region.	0
The loss, theft, destruction, or misuse of the asset or operation's /activity's compromise could have significant mission impact on a regional level.	1
The loss, theft, destruction, or misuse of the asset or operation's /activity's compromise could compromise the defense infrastructure of the United States.	2
The loss, theft, destruction, or misuse of the asset or operation's /activity's compromise could impact the tactical capability of the United States.	3
The loss, theft, destruction, or misuse of the asset or operation's /activity's compromise could be expected to harm the operational capability of the United States.	4
The loss, theft, destruction, or misuse of the asset or operation's /activity's compromise could result in great harm to the strategic capability of the United States.	5

3-5.1.3 **Asset Replacement.** This factor addresses the ease with which assets can be replaced. There are separate entries for people and assets other than people. This factor is not evaluated for the general population or sensitive information. Evaluate this factor using Table 3-6.

3-5.1.3.1 **Mission Critical Personnel.** This table reflects the difficulty of finding replacements for personnel who are injured based on the skills and training necessary for replacement personnel. Note that this factor is only applied to people who are considered mission critical. It is not applied to the general population.

3-5.1.3.2 **Assets Other Than People.** This table is based on the amount of time required to replace assets or reestablish operations and activities that have been compromised, either in-kind or with substitutes that are acceptable to the user or the Planning Team. The replacement assets or operations or activities can also be either temporary or permanent depending on the Planning Team's judgment. This factor accounts for the impact of delay in replacement of assets on the user's mission.

Table 3-6. Asset Replacement

Asset Category	Availability of Replacement Personnel or Time to Asset Replacement, Repair, or Substitution	Value Rating Factor
Mission critical personnel	Personnel would be immediately available to resume the functions of casualties	1
	Personnel would have to be transferred from other units on the installation to resume the function of the casualties	2
	Personnel would have to be transferred from other units at other installations to resume the function of the casualties	3
	Personnel would have to be trained over an extended period to resume the functions of the casualties	4
	Personnel of such a critical nature that “replacement” would not be realistic	5
All assets other than people and sensitive information (including operations and activities)	Asset can be replaced or operation / activity could be reestablished in less than 24 hours	0
	Asset can be replaced or operation / activity could be reestablished in 24 to 72 hours	1
	Asset can be replaced or operation / activity could be reestablished in 72 hours to 1 week	2
	Asset can be replaced or operation / activity could be reestablished in 1 week to 1 month	3
	Asset can be replaced or operation / activity could be reestablished in one to six months	4
	Asset will require more than a 6 months to replace or operation / activity will require more than 6 months to reestablish	5

3-5.1.4 Political Sensitivity. This factor accounts for the Planning Team’s perception of the political repercussions associated with the asset’s loss, destruction, or death or the operation’s or activity’s compromise. Considerations could include adverse publicity, erosion of confidence, and the perception of poor security. Note that political sensitivity is somewhat dependent on media attention; therefore, what asset is compromised and where may be significant factors. For example, a person being killed will be a much more politically sensitive issue than a computer being stolen. In addition, regarding people, killing a person in the Continental U.S. may be far more politically sensitive than killing somebody in a forward deployed location or a war zone. This factor is not evaluated for sensitive information. Evaluate this factor using Table 3-7.

Table 3-7. Perceived Political Sensitivity

User’s Perceived Political Sensitivity of Loss of Asset	Asset Value Rating
Negligible: Media attention would be unlikely	0
Minimal: Media attention would likely be limited to local media	1
Moderate: Media attention would likely extend to national media	3
High: Media attention would likely extend to international media.	5

3-5.1.5 **Relative Asset Value.** This factor provides a measure of the relative value of an asset based on measures of value appropriate for particular asset categories. The relative values of the different asset categories are measured in different ways. The most appropriate ways of measuring cost for various asset categories are reflected in Table 3-8. This factor is not evaluated for critical infrastructure or operations and activities. Evaluate this factor using Table 3-8.

3-5.1.5.1 **Personnel.** The relative value for personnel is based on the number of such personnel routinely inhabiting a facility. For mission critical personnel, this factor also considers the percentage of people required for mission execution that are routinely present in the facility. Assigning monetary costs to people is difficult, so value of personnel is based on numbers of people. That assumes that injuring or killing many people is inherently worse than injuring or killing only a few. There are separate entries for the general population and for mission critical personnel. Those for mission critical personnel are lower than those for the general population to reflect the increased importance to mission execution of those people. Where people are an asset and there are both mission critical personnel and general population in a building, either the higher value rating for the two categories of personnel can be applied for the entire facility or the facility can be broken onto mission critical personnel and general population areas. In the latter case, the different areas could have separate asset value ratings.

3-5.1.5.2 **Aircraft.** Relative values for aircraft are based on the types of aircraft commonly parked at an aviation facility (trainers; cargo, refueling, or utility aircraft; tactical or attack aircraft; and strategic aircraft.) They are also based on the size of the unit that operates the aircraft, either smaller or larger than squadron or company strength. This reflects the fact that a large number of aircraft is relatively more valuable than a small number.

3-5.1.5.3 **Ships, Boats, and Watercraft.** Relative value of watercraft is based on the categories of ships moored at a location, regardless of number. The relative values of those categories of ships reflect their relative importance. Ships moored near higher category vessels should be assigned the same value rating as the higher category ships.

3-5.1.5.4 **Vehicles.** Relative value for vehicles is based on similar assumptions to those for aircraft. The relative values of vehicles is based on whether they are or are not tactical vehicles or critical maintenance or support vehicles or whether they include carriage mounted or towed weapons systems. The breaks between numbers of vehicles are based on the number of vehicles in a company-sized element. The assumption is that these vehicles are in a motor pool, that the number of vehicles associated with a company-sized element constitutes a significant number, and that the loss of many vehicles is worse than the loss of a few.

3-5.1.5.5 **Petroleum, Oils, and Lubricants (POL).** The relative value of POL is based on the quantities of POL stored at the location in question. The quantities in the tables reflect the quantities handled by the various sizes of Army tactical units from battalion up to Theater Army. They are also representative of quantities handled by increasingly larger Air Force, Navy, and Marine Corps elements.

3-5.1.5.6 Arms, Ammunition, and Explosives (AA&E). The relative value of AA&E is based on its risk level as defined in DoD 5100.76-M. The categories of I through IV (highest to lowest risk, respectively) reflect the relative utility, attractiveness, and availability to criminal elements of the AA&E. As a general rule, only arms, missiles, rockets, explosive rounds, mines, and projectiles that have an unpacked unit weight of 100 pounds or less are categorized as sensitive for purposes of DoD 5100.76-M. In addition, any single container that contains a sufficient amount of spare parts that, when assembled, will perform the basic function of the end item will be categorized the same as the end item. Nuclear and chemical weapons are not to be addressed using this UFC. The requirements established in DoD instructions for protecting them are much more stringent than anything that would be established using the security engineering series of UFCs.

3-5.1.5.7 Controlled Substances and Medically Sensitive Items. Relative values for these assets are measured by their designation as sensitive items as established by the Drug Enforcement Agency and by the type of facility in which they are stored. Contact medical or pharmacy personnel to determine which of these designations apply. Quantity is accounted for in considering mission criticality. Substances that are protected under protocols for biosafety in microbiological laboratories are not within the scope of this UFC.

3-5.1.5.8 Assets with Identifiable Monetary Value. These are assets for which costs are readily definable. Their value, therefore, is based only on their value in U.S. dollars. In general, use this measure of relative value for assets that are not specifically covered by one of the asset types in this table. There are two entries for assets that are measured by their monetary value. One is to be used where only a single asset is being considered. The other is to be used where the assets are stored in quantities that are more appropriately measured as inventories.

3-5.1.5.9 Controlled Cryptographic Items. These are devices that process sensitive information. Their relative value is based on the level of sensitivity of the information they are accredited to process.

3-5.1.5.10 Sensitive Information. This is sensitive classified or unclassified information. Unlike other assets, the relative value of sensitive information is based only on this single factor. That is because many of the issues that are addressed in the criticality and replaceability factors are reflected in decisions on the classification of sensitive information.

Table 3-8. Relative Value to User

Asset Type		Measure of Relative Value	Relative Value	Value Rating Factor
People	Mission Critical Personnel	Number of people present in facility	Number of mission critical personnel in the facility is less than 5 or 10% of people needed for mission execution are routinely present in the facility	1
			Number of mission critical personnel in the facility is 6 to 10 or 25% of people needed for mission execution are routinely present in the facility	2
			Number of mission critical personnel in the facility is 11 to 49 or 50% of people needed for mission execution are routinely present in the facility	3
			Number of mission critical personnel in the facility is 50 to 100 or 75% of people needed for mission a execution re routinely present in the facility	4
			Number of mission critical personnel in the facility is greater than 100 or 90% of people needed for mission execution are routinely present in the facility	5
	General Population	Number of people present in facility	Number of people in the facility is less than 11	0
			Number of people in the facility is 11 to 49	1
			Number of people in the facility is 50 to 100	2
			Number of people in the facility is 101 to 500	3
			Number of people in the facility is 501 to 1000	4
			Number of people in the facility is greater than 1000	5
Aircraft	Organizational unit and aircraft type	Aircraft limited to trainers	1	
		Aircraft include cargo, refueling, or utility type aircraft in units of less than company or squadron strength	2	
		Aircraft include cargo, refueling, or utility type aircraft in units of greater than company or squadron strength	3	
		Aircraft include tactical or attack type aircraft in units of less than company or squadron strength	3	
		Aircraft include tactical or attack type aircraft in units of greater than company or squadron strength	4	
		Aircraft include strategic aircraft	5	
Watercraft	Number and type of watercraft	All other watercraft	1	
		Patrol Coastal, MSC strategic sealift ships (reduced operational status)	2	
		Surface combatants, other amphibious, auxiliary, MSC, strategic sealift ships, ammunition ships, and mine warfare	3	
		Aircraft carriers or large deck amphibious (LHA,LHD, etc.) and other submarines	4	
		SSBN and Sea Based X-Band Radar (SBX)	5	

(Table 3-8 continued)

Vehicles	Number and type of vehicles	Fewer than 20 vehicles are parked in the vehicle parking area or motor pool. Vehicles do not include tactical vehicles, carriage mounted or towed weapons systems, or critical maintenance or support vehicles	1
		Fewer than 20 vehicles are parked in the vehicle parking area or motor pool. Vehicles include tactical vehicles and critical maintenance or support vehicles, but do not include carriage mounted or towed weapons systems	2
		Fewer than 20 vehicles are parked in the vehicle parking area or motor pool. Vehicles include carriage mounted or towed weapons systems	3
		20 or more vehicles are parked in the vehicle parking area or motor pool. Vehicles do not include tactical vehicles, carriage mounted or towed weapons systems, or critical maintenance or support vehicles	3
		20 or more vehicles are parked in the vehicle parking area or motor pool. Vehicles include tactical vehicles and critical maintenance or support vehicles, but do not include carriage mounted or towed weapons systems	4
		20 or more vehicles are parked in the vehicle parking area or motor pool. Vehicles include carriage mounted or towed weapons systems	5
		Petroleum, Oils, and Lubricants	Quantity stored
Quantity of fuel stored is greater than or equal to 190,000 liters (50,000 gallons) and less than 570,000 liters (150,000 gallons)	2		
Quantity of fuel stored is greater than or equal to 570,000 liters (150,000 gallons) and less than 1,900,000 liters (500,000 gallons)	3		
Quantity of fuel stored is greater than or equal to 1,900,000 liters (500,000 gallons) and less than 3,800,000 liters (1,000,000 gallons)	4		
Quantity of fuel stored is greater than or equal to 3,800,000 liters (1,000,000 gallons)	5		
Arms, Ammunition, and Explosives	Risk category (DoD 5200.76M)		
		Category IV	2
		Category III	3
		Category II	4
		Category I	5

(Table 3-8 continued)

Controlled Substances and Medically Sensitive Items	Sensitivity and storage location	Non-sensitive pharmaceuticals and other non-sensitive medical items	1
		Medically sensitive items in pharmacies, wards, clinics, or RDT&E facilities	2
		Medically sensitive items in bulk storage facilities	3
		Items identified as Note R in the Federal Supply Catalog, non-standard DEA Schedule II controlled substances , or standard drug items identified as Note Q in the Federal Supply Catalog , non-standard DEA Schedule III, IV, and V controlled substances in pharmacies, wards, clinics, or RDT&E facilities	4
		Items identified as Note R in the Federal Supply Catalog, non-standard DEA Schedule II controlled substances , or standard drug items identified as Note Q in the Federal Supply Catalog , non-standard DEA Schedule III, IV, and V in bulk storage facilities	5
Individual Assets with Monetary Value	Replacement cost	Asset value is less than \$2500	0
		Asset value is greater than or equal to \$2500 and less than \$10,000	1
		Asset value is greater than or equal to \$10,000 and less than \$25,000	2
		Asset value is greater than or equal to \$25,000 and less than \$50,000	3
		Asset value is greater than or equal to \$50,000 and less than \$100,000	4
		Asset value is greater than \$100,000	5
Inventories of Assets with Monetary Value	Replacement cost	Asset inventory value is less than \$100,000	0
		Asset inventory value is greater than or equal to \$100,000 and less than \$250,000	1
		Asset inventory value is greater than or equal to \$250,000 and less than \$500,000	2
		Asset inventory value is greater than or equal to \$500,000 and less than \$1,000,000	3
		Asset inventory value is greater than or equal to \$1,000,000 and less than \$2,000,000	4
		Asset inventory value is greater than \$2,000,000	5
Controlled Cryptographic Items (CCI)	Sensitivity of information processed	CCI processes unclassified and non-sensitive information	0
		CCI processes unclassified, but sensitive information (i.e. For Official Use Only)	1
		CCI processes Confidential information	2
		CCI processes Secret information	3
		CCI processes Top Secret information	4
		CCI processes Secure Compartmented information	5
Sensitive Information	Sensitivity or classification level	Unclassified sensitive (i.e. For Official Use Only)	5
		Confidential	7.5
		Secret	8.5
		Top Secret	9.5
		Secure Compartmented Information	10

3-5.2 **Determine Asset Value Rating.** Asset value ratings (except for sensitive information) are determined based on the sums of the applicable value rating factors and the percentages of the possible points those sums represent. Sum the applicable value rating factors for each asset and enter the sum in the appropriate box on the Asset Value/Aggressor Likelihood Worksheet. Then divide the sums by the applicable number of points possible for that asset category. Those total numbers of points will be 10 for sensitive information, 15 for general population, 20 for critical infrastructure and activities and operations, and 25 for all other assets. The resulting percentage is the asset value rating. Enter it in the appropriate boxes on the Asset Value/Aggressor Likelihood Worksheet as illustrated in Figure 3-4. Also enter it on the Design Criteria Summary Worksheet, the Tactic, Threat Severity, and Level of Protection Worksheet, and the Risk Level Calculation Worksheet.

3-5.3 **Eliminate Assets with “Very Low” Value Ratings.** Assets whose value ratings are less than or equal to 0.5 may be considered to be of minimal value and do not warrant further analysis. Eliminate those assets from further consideration. For those assets only countermeasures required by regulation or measures required by one or more of the minimum construction standards (either DoD or Combatant Command) should be applied. For other assets continue on to the next step of the procedure.

3-6 **STEP 4: IDENTIFY AGGRESSOR LIKELIHOODS.** The next step in the procedure after identifying the assets and their values is to look at those assets from the perspective of potential aggressors. This step includes identifying potential aggressors and determining the likelihoods that they will attempt to compromise the assets.

3-6.1 **Select Applicable Aggressors.** Table 3-9 indicates which of the 10 aggressor types defined in chapter 2 are likely to attempt to compromise assets in each of the 18 established asset categories. These aggressor selections represent default potential aggressors and were established based on assessment of the common goals and characteristics historically exhibited by those aggressor types. Further evaluation by the Planning Team relative to a specific asset’s locality is required to make a final determination of the applicable aggressors. Indicate on the Asset Value/Aggressor Likelihood Worksheet the aggressor types applicable to an asset by placing "X's" or check marks in the spaces adjacent to them. Note that Table 3-9 also includes default aggressor goals, which are used later in the chapter.

3-6.2 **Assess Aggressor Likelihood Ratings.** The likelihood that a given aggressor will attempt to compromise an asset is evaluated using 14 likelihood rating factors for terrorists and 11 likelihood rating factors for all other aggressors. Each of those factors is described below. The factors measure likelihood by considering issues that reflect how likely an aggressor is to know that an asset exists, how common the asset is, where it is located, history of attacks on those assets, the state of law enforcement support, how it is stored, and the threat level. There are also asset specific considerations of the relative value of the asset to the aggressors. In evaluating the individual likelihood rating tables, select the entry from each applicable table that most closely applies to the aggressor and the asset. The rating factors are evaluated on scales of 0 to 5, 0 to 10, 0 to 15, 0 to 20, or 0 to 30. In the higher range cases, the rating factors are rated higher to reflect increased importance of the issues reflected in

Figure 3-4. Sample Asset Value / Aggressor Likelihood Worksheet

ASSET VALUE/AGGRESSOR LIKELIHOOD WORKSHEET																			
Project or Building		Asset		Analyst		Likelihood Rating Factors								Sum of Likelihood Factors		Likelihood Ratings ⁷			
A Motor Pool		Tactical vehicles		Jane Q. Planner		History ⁵ / Intentions ⁶ Threat Level Aggressors' Perception of Success Law Enforcement ⁴ Relative Value to Aggressor Recognizability Dynamics ⁴ Availability ⁴ Accessibility ⁴ Publicity Profile ⁴ Installation Location ⁴								Sum of Value Factors Value Rating ²		Sum of Likelihood Factors Activity ⁶		Likelihood Ratings ⁷	
		Asset Category		Date															
		D		4 August 2008															
		Aggressors		M		2	4	2	2	3	12	15	18	24	6	6	94	.52	
		Unsophisticated Criminals		M		2	4	2	2	3	12	12	18	24	6	6	91	.51	
		Sophisticated Criminals		M		2	4	2	2	3	15	9	18	30	6	6	97	.54	
		Organized Criminal Groups		G		2	4	2	2	3	12	6	18	24	6	6	85	.47	
		Vandals		G		2	4	2	2	3	15	6	18	24	6	6	88	.49	
		Extremist Protesters		G		2	4	2	2	3	15	9	18	24	5	4	102	.57	
		Domestic Terrorists		G		2	4	2	2	3	15	9	18	24	5	8	116	.64	
		International Terrorists		G		2	4	2	2	3	15	9	18	30	5	10	130	.72	
		State Sponsored Terrorists		G		2	4	2	2	3	15	9	18	30	5	10	91	.51	
		Saboteurs		G		2	4	2	2	3	15	3	18	30	6	6			
		Foreign Intelligence Services																	

1. Population Type applies to General Population only
2. Sum of Value Ratings + 10 for Sensitive Information 15 for General Population; 20 for Critical Infrastructure and Operations and Activities; 25 for all other assets
3. G for mission related goal, M for publicity related goal, P for monetary related goal.
4. Factors that should be same for all aggressors for given asset
5. Applies to all aggressors other than terrorists
6. Applies to Terrorists only
7. Sum of Likelihood Ratings + 180

those factors. The likelihood rating factors can be subdivided into three main areas: factors relating to the assets themselves (the first 7), factors relating to asset protection (law enforcement and perception of success), and factors relating to history, threat level, and characteristics of terrorist groups (all others). The sums of all the factors within each of those areas are 1/3 of the total (180). Where the differences in meaning between descriptions in the tables are difficult to determine, think of them in terms of “on a scale of 0 to 5” or whatever the applicable range may be. Record the numerical values for the applicable likelihood rating factors in the appropriate spaces on the Asset Value/Aggressor Likelihood Worksheet.

Table 3-9. Potential Aggressors and Default Goals

Asset Categories		Default Aggressor Types									
		Unsophisticated Criminals	Sophisticated Criminals	Organized Criminal Groups	Vandals	Extremist Protest Groups	Domestic Terrorists	International Terrorists	State Sponsored Terrorists	Saboteurs	Foreign Intelligence Services
A	People			G	P	P	P	P	P	G	
B	Aircraft and Components at Aviation Facilities	M	M	M	P	P	P	P	P	G	
C	Ships, Boats, and Other Watercraft	M	M	M	P	P	P	P	P	G	
D	Vehicles and carriage mounted or towed weapons systems	M	M	M	P	P	P	P	P	G	
E	Petroleum, Oils, and Lubricants	M	M	M	P	P	P	P	P	G	
F	Arms, Ammunition, and Explosives	M	M	M	P	1	1	1	1	G	
G	Controlled Medical Substances and Medically Sensitive Items	M	M	M							
H	Communications / Electronics Equip. and Night Vision Devices	M	M	M							
I	Organizational Clothing and Individual Equipment	M	M	M							
J	Subsistence Items at Commissaries, Warehouses, & Troop Issue Facilities	M	M	M							
K	Repair Parts at Installation Supply and Direct Support Units	M	M	M							
L	Facilities Engineering Supplies and Construction Material	M	M	M							
M	Audiovisual Equipment, Training Devices, and Subcaliber Devices	M	M	M							
N	Miscellaneous Pilferable Assets (other than above) and Money	M	M	M							
O	Critical Infrastructure and Industrial Equipment				P	P	P	P	P	G	
P	Controlled Cryptographic Items		M	M						G	G
Q	Sensitive Information			G						G	G
R	Activities and Operations			G		G	P	P	P	G	G

1. May be mission, publicity, or monetary related goal (see Table 3-16)
G = Mission related goal P = Publicity related goal M = Monetary related goal

3-6.2.1 Installation Location. This factor reflects the assumption that installations that are outside the Continental United States are more likely targets of attack than those in the Continental United States and that the threat is higher near major population centers. Use Table 3-10 to evaluate this factor.

Table 3-10. Asset Location

Installation or facility Location	Likelihood Rating Factor
Located within the Continental United States away from major metropolitan areas	1
Located within the Continental United States near a major metropolitan area	2
Located outside the Continental United States away from major metropolitan areas	4
Located outside the Continental United States near a major metropolitan area	5

3-6.2.2 Publicity Profile. This factor addresses the level of publicity associated with an installation or facility. It accounts for the fact that some installations are very controversial and well known throughout a region while others are rather obscure. This factor is based on the assumption that installations or facilities that have a high publicity profile are more likely targets than those that are relatively unknown. Use Table 3-11 to evaluate this factor.

Table 3-11. Installation or Facility Publicity Profile

Level of Publicity Associated with Installation or Facility	Likelihood Rating Factor
Installation or facility is relatively unknown both locally and regionally.	1
Installation or facility is well known locally but is relatively unknown regionally.	2
Installation or facility is well known locally and regionally, but it relatively un known nationally.	3
Installation or facility is well known locally, regionally, and nationally, but is relatively unknown internationally	4
Installation or facility is well known locally, regionally, nationally and internationally	5

3.6.2.3 Accessibility. This factor addresses the assumption that assets are more vulnerable when the facilities in which or at which they are stored are readily accessible. This factor is evaluated using Table 3-12, which addresses whether or not the facility is on an “open” or access controlled installation and the proximity of the facility to the installation perimeter.

Table 3.12 Asset Accessibility

Asset Location and Access Controls	Likelihood Rating Factor
The facility in which or at which the asset is located is on a closed military installation or government compound to which access is controlled, the facility is in a separate access controlled compound interior of the installation, and there are no direct lines of sight to the facility from outside the installation	0
The facility in which or at which the asset is located is on a closed military installation or government compound to which access is controlled and the facility is in the interior of the installation	2
The facility in which or at which the asset is located is on a closed military installation or government compound to which access is controlled and the facility is within 100 meters of the installation perimeter	4
The facility in which or at which the asset is located is on an open military installation or government compound to which access is not controlled and the facility is in the interior of the installation	6
The facility in which or at which the asset is located is on an open military installation or government compound to which access is not controlled and the facility is within 100 meters of the installation perimeter	8
The facility in which or at which the asset is located is not on a military installation or government compound	10

3-6.2.4 **Asset Availability.** This factor assesses how common the asset is in the general area where it is located. The rating table addresses availability both on military installations or at other sites where military assets are housed and in their immediate vicinities. It reflects the assumption that the likelihood that an aggressor will attempt to compromise an asset in one particular location is less if it is widely available, assuming all locations are equally likely. Conversely, the likelihood increases if the location in question is the only place the asset can be found and it assumed the aggressor wants that specific asset. Use Table 3-13 to evaluate this factor.

Table 3-13. Asset Availability

Asset Availability	Likelihood Rating Factor
Similar assets are widely available both on and in the immediate vicinity off the installation or site	0
Similar assets have limited availability in the immediate vicinity off the installation, but are widely available on the installation or site	1
Similar assets are not available in the immediate vicinity off the installation, but are widely available on the installation or site	2
Similar assets have limited availability on the installation and are not available in the immediate vicinity off the installation or site	3
Similar assets are available at fewer than 3 other locations on the installation and are not available in the immediate vicinity off the installation or site	4
There are no similar assets on or off the installation except at this location or site	5

3-6.2.5 Asset Dynamics. This factor accounts for the assumption that an aggressor is less likely to attempt to attack an asset that is moved frequently or randomly because of the uncertainty of its location at any given time and the uncertainties in planning inherent in that condition. Use Table 3-14 to evaluate this factor.

Table 3-14. Asset Dynamics

Frequency of Asset Relocating or Moving	Likelihood Rating Factor
Asset is moved frequently on a random basis	1
Asset is moved frequently on a predictable basis	2
Asset is moved periodically on a random basis	3
Asset is moved periodically on a predictable basis	4
Asset is not moved.	5

3-6.2.6 Recognizability. This rating factor assesses how likely an aggressor is to know that an asset exists in the location where it is located. That likelihood should be evaluated based on assumptions about the sophistication of the aggressor and the amount of training or intelligence support the aggressor would need to be aware of the asset. Use Table 3-15 to evaluate this factor for all assets. Select the likelihood rating factor from the column that corresponds to the applicable aggressor. Different ratings factors apply to different aggressors to reflect their assumed intelligence capabilities.

Table 3-15. Recognizability

Recognizability	Likelihood Rating Factor		
	Unsophisticated Criminals Sophisticated Criminals Vandals	Organized Criminal Groups Extremist Protest Groups Domestic Terrorists	International Terrorists State Sponsored Terrorists Saboteurs Foreign Intelligence Services
The asset's existence can be recognized only by aggressors who are experts or who have expert intelligence support	3	6	9
The asset's existence can be recognized only by aggressors with a significant amount of training or intelligence support	6	9	12
The asset's existence can be recognized only by aggressors with a moderate amount of training or intelligence support	9	12	15
The asset's existence can be recognized only by aggressors with a minor amount of training or intelligence support	12	15	15
The asset's existence is obvious to the aggressor. It can be recognized by aggressors with little or no training or intelligence support	15	15	15

3-6.2.7 **Relative Value to Aggressor.** This factor assesses how likely aggressors are to attempt to target assets based on the value of those assets to those aggressors. Relative value is addressed differently for different aggressors and asset categories. Relative value is measured on the basis of an asset's value to the aggressors in achieving future or mission goals, the resultant publicity associated with destroying an asset, or the monetary value of an asset. Use Table 3-16 in evaluating this factor subject to the guidance below and the notes in the table. Enter the assumed goal of the aggressor into the appropriate space in the Asset Value/Aggressor Likelihood Worksheet for each aggressor using the abbreviations below. The aggressor goals will be used to select among options in Table 3-16. Default aggressor goals are tabulated in Table 3-9. They can be evaluated by the Planning Team for applicability.

- **G** where targeting the asset meets a specific mission related goal of an aggressor or where it can be used in future attacks
- **P** where the goal of targeting the asset would be to gain publicity
- **M** where the goal for targeting the asset would be related to its monetary value such as to sell it

3-6.2.7.1 **Value to Mission or Future Goals.** Use this portion of Table 3-16 to assess the value for assets where targeting them would satisfy a particular mission goal of the aggressor. This principally applies to saboteurs and foreign intelligence services because their primary interest in assets is likely to be associated with their mission to compromise them. This also applies to terrorists and extremist protest groups who might steal arms, ammunition, and explosives for the purposes of using them in a future attack. For organized criminal groups, use this portion of the table only where it is likely that they will target assets or officials for the purpose of deterring law enforcement officials from targeting them or for some similar purpose.

3-6.2.7.2 **Publicity Value.** Use this portion of Table 3-16 where the value of assets to users is likely to be based on the amount of publicity the aggressors could expect if they targeted the asset.

3-6.2.7.3 **Relative Value Based on Asset Cost.** Use these portions of Table 3-16 to assess value for assets for which a monetary cost can be identified and is the best measure of asset value to potential aggressors. The cost ranges in this table are the same as those previously used to assess asset value to the user, except for assets whose values to their users were not based on their costs (vehicles, POL, AA&E, and controlled cryptographic items.) For those assets, for the purposes of this table, estimate their monetary value. Use the upper portion where only one or a small number of assets are being considered and use the lower portion where asset inventories are more applicable in describing the asset quantities, as in assets stored in bulk. Note also that the points associated with cost ranges vary by aggressor. That reflects the assumption that sophisticated aggressors will not target low value assets and that unsophisticated criminals do not have the capability to effectively dispose of high value assets.

Table 3-16. Relative Value to Aggressors

Asset Category	Aggressor	Aggressor Goal ¹	Relative Value	Likelihood Rating Factor
A B C D E F ² O P Q R	Saboteurs and Foreign Intelligence Agents, or Organized Criminal Groups ³	Target asset for value to mission or support to future goals	Compromising assets would have negligible utility to accomplishment of aggressor's mission or future goals.	0
			Compromising assets would have minor utility to accomplishment of aggressor's mission or future goals.	3
			Compromising assets would have moderate utility to accomplishment of aggressor's mission or future goals.	6
			Compromising assets would have significant utility to accomplishment of aggressor's mission or future goals.	8
			Compromising assets would have major utility to accomplishment of aggressor's mission or future goals.	12
			Compromising assets would likely be critical to accomplishment of aggressor's mission or success of future goals.	15
			A B C D E F ² O P R	Terrorist / Extremist Protest Group, Vandals
Aggressor is likely to believe asset's compromise would result in publicity limited to local media	3			
Aggressor is likely to believe asset's compromise would result in publicity that would likely extend to national media	9			
Aggressor is likely to believe asset's compromise would result in publicity that would likely extend to international media	15			

Table 3-16 (continued)

Asset Category	Aggressors ⇔	Aggressor Goal ¹	Relative Value	Likelihood Rating Factors			
				Unsophisticated Criminals	Sophisticated criminals	Organized criminal groups	Others ⁵
B C D E F ² G H I J K L M N P	Individual assets ⁴	Target asset for Monetary value	Asset value is less than \$2500	9	3	0	3
			Asset value is greater than or equal to \$2500 and less than \$10,000	12	6	3	6
			Asset value is greater than or equal to \$10,000 and less than \$25,000	15	9	6	9
			Asset value is greater than or equal to \$25,000 and less than \$50,000	15	12	9	12
			Asset value is greater than or equal to \$50,000 and less than \$100,000	12	15	12	15
			Asset value is greater than \$100,000	9	15	15	15
			B E F ² G H I J K L M N P	Asset inventories ⁴	Target asset for Monetary value	Asset inventory value is less than \$100,000	9
Asset inventory value is greater than or equal to \$100,000 and less than \$250,000	12	6				3	6
Asset inventory value is greater than or equal to \$250,000 and less than \$500,000	15	9				6	9
Asset inventory value is greater than or equal to \$500,000 and less than \$1,000,000	15	12				9	12
Asset inventory value is greater than or equal to \$1,000,000 and less than \$2,000,000	12	15				12	15
Asset inventory value is greater than \$2,000,000	9	15				15	15

Notes:

1. Select applicable measure of asset value to aggressors (defaults at Table 3-9).
2. For arms, ammunition, and explosives (AA&E) subject to action by terrorists or extremist protest groups, select the upper factor if the goal is to steal the AA&E for use in future attacks, select the second if the goal is to destroy it, and among the lower two if the goal is to steal and sell it.
3. Only use this factor for organized criminal groups where it is likely they would kill people to further their goals. See paragraph 3-6.2.7.1.
4. Select between factors based on whether analyzing individual assets or inventory of assets.
5. Use only where non-criminal aggressors are likely to steal assets to sell them.

3-6.2.8 **Law Enforcement Personnel Visibility.** This factor should be addressed in conjunction with installation law enforcement personnel. It addresses the visibility of law enforcement personnel or guards at an installation perimeter or in the vicinity of a facility and reflects the assumption that a strong law enforcement or guard presence can limit the likelihood that an aggressor will attempt to compromise assets there. It can be evaluated with respect to DoD or military police, contract or unit guards, and local or host nation law enforcement personnel as applicable. Use Table 3-17 in evaluating it. Enter the matrix on the left with the frequency of law enforcement or guard presence at the installation perimeter and enter it at the top with frequency of presence in the immediate vicinity of the facility housing the asset. Read the value rating factor at the intersection of the two frequencies. Note that the range of likelihood rating factors is higher for this factor because of its added significance to likelihood.

Table 3-17. Law Enforcement Personnel Visibility

		Frequency of Presence in Vicinity of Facility			
		Infrequent	Occasional	Frequent	Continuous
Frequency at Installation Perimeter	Occasional	30	24	18	12
	Scheduled	24	18	12	6
	Continuous	18	12	6	0

3-6.2.9 **Aggressors' Perception of Success.** This factor assesses aggressors' likely perception of the possibility that they will successfully compromise an asset and escape (where escape is a goal). It should be evaluated considering visible countermeasures that exist, are planned, or are otherwise likely to be present, in the context of how they would likely deter aggressors or otherwise affect their perception of their chances for success. At this point, countermeasures should only be considered in a very general sense. Specific countermeasures and their contribution to mitigation of vulnerabilities will be assessed in more detail in the design phase of this process using UFC 4-020-02. Use Table 3-18 to evaluate aggressor perceptions as described below. Note that more sophisticated aggressors are likely to be less easily deterred than less sophisticated ones. Where the differences in meaning between entries in the table are difficult to determine, think of them in terms of "on a scale of 6 to 30" with respect to the likely affect on aggressor perception.

3-6.2.9.1 **Exterior Assets.** This assesses deterrence due to visible countermeasures common to security of assets stored in exterior areas assuming the aggressor will try to gain

access to the assets. Consider measures such as fences, lighting, intrusion detection systems (IDS), and closed circuit television (CCTV).

3-6.2.9.2 Interior Assets. This assesses the deterrence from visible security measures applied to assets stored inside structures assuming the aggressor will try to gain access to the assets. Consider the effect of building construction (walls, roofs, windows, and doors) and how it may provide resistance to forced entry. For example, reinforced concrete or masonry construction, heavy doors, and window barriers are commonly more resistant than lighter weight construction. Also consider perimeter security such as fences or walls, interior locations of assets, and measures such as IDS and CCTV.

3-6.2.9.3 Interior Assets Subject to Destruction. This is assessed for assets that are stored inside structures and are subject to being damaged or, in the case of people, killed. Consider how the building construction might be or might appear to be resistant to weapons and explosives effects. Again, reinforced concrete or masonry construction is generally more resistant than lightweight construction.

Table 3-18. Aggressors' Perception of Success

Aggressor's Likely Perception of Possibility of Success Based on Likely Presence of Visible Countermeasures	Likelihood Rating Factor
Based on the visible countermeasures that are likely to be present or are present at the facility where the asset is or will be located, aggressor would likely perceive a very low possibility of successfully compromising or destroying the asset and escaping.	6
Based on the visible countermeasures that are likely to be present or are present at the facility where the asset is or will be located, aggressor would likely perceive a low possibility of successfully compromising or destroying the asset and escaping.	12
Based on the visible countermeasures that are likely to be present or are present at the facility where the asset is or will be located, aggressor would likely perceive a moderate possibility of successfully compromising or destroying the asset and escaping.	18
Based on the visible countermeasures that are likely to be present or are present at the facility where the asset is or will be located, aggressor would likely perceive a high possibility of successfully compromising or destroying the asset and escaping.	24
Based on the visible countermeasures that are likely to be present or are present at the facility where the asset is or will be located, aggressor would likely perceive a very high possibility of successfully compromising or destroying the asset and escaping.	30

3-6.2.10 Threat Level. This factor addresses the general level of threat activity for a country, region, or locale. It will be evaluated differently for terrorists than for all other aggressors. In the case of terrorists, use the applicable DoD or Combatant Command terrorist threat level established for the locality or region. Those levels will be low, moderate,

significant, or high as established in DoD O-2000.12-H. Established terrorist threat level methodologies commonly include considerations of the presence of a threat, operational capability, intentions, activity, and the operating environment. Those are the basis for the DoD and Combatant Command threat level determinations.

Terrorist threat levels can commonly be obtained from intelligence sources or from antiterrorism officers, who should be part of the Planning Team. Criminal, protester, foreign intelligence, and saboteur threat levels can be assigned similar descriptors to reflect the activity of those aggressors in an area. While the same considerations can be taken into account for threat levels for aggressors other than terrorists, the programs for doing so are far less formal than for terrorists. The information for those assessments may be established locally or by regional or national level entities. It should be available to local intelligence or law enforcement personnel, who should be part of the Planning Team.

Use Table 3-19 to assess likelihood ratings for this factor. Note that the range for aggressors other than terrorists is higher than for terrorists. The reason for that is that for terrorists the specific threat methodology factors of intention, operational capability, operational environment, and activity are addressed separately on a local basis, while they are all effectively incorporated into one factor for the other aggressors. By using different ranges for the factors, the overall weighting for the similar “groups” of factors is maintained at 1/3 of the total.

Table 3-19. Threat Level

Terrorist, Criminal, Vandal, Protestor, Foreign Intelligence, or Saboteur Threat Level	Likelihood Rating Factor	
	Terrorists	All Other Aggressors
Low	5	6
Moderate	10	14
Significant	15	22
High	20	30

3-6.2.11 History / Intentions. These are actually two closely related factors. History applies to all aggressors except for terrorists. It addresses the fact that previous attempts to compromise assets are potentially good indicators of future attempts to do so. It also reflects the fact that such attempts locally or regionally are better indicators than attempts elsewhere in the world and that more recent attempts are also potentially better indicators. Evaluate this factor in the contexts of each applicable aggressor’s history.

Use intentions as a consideration in evaluating the local terrorist threat. Intentions reflect the stated and/or actual history of particular terrorist groups attacking U.S. Interests. For more information on intentions, refer to DoD O-2000.12-H.

Use Table 3-20 to evaluate both history and intentions. The ranges of the factors for terrorists and for other aggressors are the same as for the threat level factor described above.

Table 3-20. History of Acts Against Like Assets / Terrorist Intention

Aggressor / Factor	History or Intention	Likelihood Rating Factor
Aggressor: All except terrorists Factor: History	There is no history of attacking or otherwise compromising assets of this type.	6
	There is little or no history of attacking or otherwise compromising assets of this type.	12
	There is history of attacking or otherwise compromising assets of this type, but not locally or regionally.	18
	There is local or regional history of attacking or otherwise compromising assets of this type in the past 10 years.	24
	There is a strong history of attacking or otherwise compromising assets of this type locally and regionally in the past 3 years.	30
Aggressor: Terrorists Factor: Intentions	No history of attacks	2
	Anti-U.S. ideology, but no direct attacks	4
	Anti-U.S. ideology, with a history of attacks outside region	6
	Recent attacks against U.S. interests regionally	8
	Recent attacks against U.S. interests locally	10

3-6.2.12 **Operational Capability.** This factor should be used to assess the local terrorist threat. It should not be applied for any other aggressors. Operational capability is the acquired, assessed, or demonstrated level of operational capability to conduct terrorist attacks. For more information on this factor, refer to DoD 0-2000.12-H. Use Table 3-21 to evaluate this factor.

Table 3-21. Terrorist Operational Capability

Capability to Conduct Terrorist Attack	Likelihood Rating Factor
Insignificantly capable	2
Minimally capable	4
Capable	6
Very capable	8
Extremely capable	10

3-6-2.13 **Operating Environment.** This factor considers how the overall environment, to include political and security considerations, influences a terrorist group's ability and motivation to conduct an attack. It should not be applied for any other aggressors. For more information on this factor, refer to DoD 0-2000.12-H. Use Table 3-22 to evaluate this factor.

Table 3-22. Terrorist Operating Environment

Environment for Terrorists Operating	Likelihood Rating Factor
Favors U.S. or host nation	2
Neutral	6
Favors terrorist	10

3-6.2.14 **Activity.** This factor considers the fact that a terrorist group’s activity in a country may not always be related to operational planning or present a threat to U.S. / Host Nation interests. Many groups use countries as support bases and may not want to jeopardize their status by conducting terrorist acts there. For more information on this factor, refer to DoD 0-2000.12-H. Use Table 3-23 to evaluate this factor.

Table 3-23. Terrorist Activity

Terrorist Activities in the Applicable Country or Region	Likelihood Rating Factor
Present but inactive	2
Recruiting, fund-raising or non-directed activity	4
Suspected surveillance, threats, and suspicious incidents	6
Identified cell activity (operational or support)	8
Credible indications of targeting U.S. assets	10

3-6.3 **Determine Likelihood Ratings.** Likelihood ratings are determined based on the sums of the 11 or 14 applicable likelihood rating factors, depending on whether the applicable aggressor is a terrorist or any of the other aggressor categories. Sum the likelihood rating factors for each asset and enter their sums in the appropriate boxes on the Asset Value/Aggressor Likelihood Worksheet. Then divide the sums by the total number of points possible (180). The resulting percentages are the aggressor likelihood ratings. Enter them in the appropriate boxes on the Asset Value/Aggressor Likelihood Worksheet as well as on the Tactic, Threat Severity, and Level of Protection Worksheet and the Risk Level Calculation Worksheets.

3-6.4 **Aggressors with “Very Low” Likelihood Ratings.** Aggressors who have likelihood ratings of less than or equal to 0.5 need not be considered for further evaluation. Because of their very low assessed likelihood it is unlikely that they will be a threat to the assets under consideration and the risk of ignoring them should be acceptable. Any aggressors who have a likelihood rating of higher than 0.5 should be further evaluated in the next step. Enter the likelihood ratings for those aggressors on the Tactic, Threat Severity, and Level of Protection Worksheet in the applicable locations, using one worksheet for each asset. If all aggressors have received likelihood ratings of 0.5 or less, there will be no threat postulated for the asset and only minimum measures required by regulation and measures required by minimum construction standards (DoD or Combatant Command) should be applied.

3-7 **STEP 5. IDENTIFY TACTICS AND THREAT SEVERITY LEVELS.** The tactics aggressors are likely to use in attempting to compromise assets can be selected on a default basis considering the likely objectives of the aggressors toward the assets and the asset categories. The threat severity levels will indicate the initial tools, weapons, explosives, or agents that will be associated with those tactics for the purposes of the planning level risk analysis. These form the basis for a preliminary protective system for an asset that can be used to develop a planning level cost estimate. These threat severity levels may be adjusted based on the risk analysis results with the adjusted levels becoming part of the design criteria for the project. Selecting the likely tactics is a two-step process. The first step is to identify the tactics based only on the assets and the second is to consider the aggressors. Selecting the initial threat severity levels is a third step.

3-7.1 **Select Applicable Tactics Based on Assets.** Use Table 3-24 to determine which of the 13 tactics defined in Chapter 2 may apply against the identified assets based on the asset categories. These are default tactics based only on the asset category and do not include considerations of which aggressors are likely to carry out those tactics or if the specific goals of aggressors toward an asset would lead them to use that tactic against it. Those considerations will be addressed in the next step. Table 3-24 includes all the tactics that any aggressor might use against the asset.

3-7.2 **Select Applicable Tactics Based on Aggressors.** The previous step excluded aggressor considerations. In this step those considerations are taken into account. Use Table 3-25 to do the final selection of applicable tactics. That table reflects considerations relating to tactics specific aggressors may use based on their likely goals toward the asset. Select tactics for each applicable aggressor for which there are entries under a tactic. As an illustration of the additional filtering associated with this step, Table 3-25 indicates that hand delivered devices may be used against arms, ammunition, and explosives. In evaluating criminals with respect to that asset, Table 3-25 would not attribute that tactic to the criminals, who are limited to theft-oriented tactics. Enter "X's" or check marks in the appropriate locations for the applicable tactics on the Tactic, Threat Severity, and Level of Protection Worksheet as illustrated in Figure 3-5. These are the initial default tactics. If in the judgment of the Planning Team any of the default tactics do not apply, do not enter them on the worksheet. Similarly, if the Planning Team thinks tactics that were not included in the default tactics should be included, add them.

3-7.3 **Identify Threat Severity Levels.** A range of tools, weapons, explosives, or agents may apply to each tactic. A tactic's threat severity level defines which tools, weapons, explosives, or agents within that range apply for a given threat. Threat severity levels may be designated as very low, low, medium, high, or very high. Different tactics may have different numbers of possible threat severity levels. In some cases, a tactic only has one possible threat severity level. In those cases, the severity level is indicated by a "yes." In addition, some of those levels are not postulated to apply to all aggressors. The threat severity levels are selected based upon the likelihood ratings for the applicable aggressors. Selecting threat severity levels considering likelihood of aggression is based on the principles of risk acceptance. If the likelihood of aggression for an aggressor is low, the protective system can be designed for a threat severity level lower than the maximum threat severity level for that aggressor. That is based on the user assuming that the aggressors will expend less effort

Figure 3-5. Sample Tactic, Threat Severity, and Level of Protection Worksheet

TACTIC, THREAT SEVERITY, AND LEVEL OF PROTECTION WORKSHEET															
Project or Building	Asset			Analyst					Asset Value						
	Tactical Vehicles			Jane Q. Planner					Date						
A Motor Pool	D			4 August 2008					0.76						
	Tactics			Explosives and Incendiary Devices			Standoff Weapons		Entry		Surveillance and Eavesdropping		Contamination		Aggressor Likelihood
Aggressors			Moving Vehicle	Stationary Vehicle Devices	Hand Delivered Devices	Indirect Fire Weapons	Direct Fire Weapons	Forced Entry	Covert Entry	Visual Surveillance	Acoustic Eavesdropping	Electronic Emissions	Airborne Contamination	Waterborne Contamination	Waterfront Attack
Applicable Tactics			✓	✓	✓	✓	✓	✓	✓						
Unsophisticated Criminals								L	L	L					
Sophisticated Criminals								L	L	L					
Organized Criminal Groups					L		L	L	L	L					
Vandals															
Extremist Protesters															
Domestic Terrorists				L	M	L	L	L	L	L					
International Terrorists				L	M	L	L	L	L	L					
State Sponsored Terrorists				L	M	L	L	M	L	L					
Saboteurs					M	L	L	M	L	L					
Foreign Intelligence Services															
Initial Design Basis Threat (highest Threat Severity Level for each tactic)				L	M	L	L	M	L	L					
Initial Level of Protection for Applicable Tactic (Table 3-28)				M	M	M	L	M	M	M					

Table 3-24. Applicable Asset / Tactic Selection

Asset Categories		Applicable Tactics												
		Moving Vehicle Bomb Tactic	Stationary Vehicle Bomb Tactic	Hand Delivered Devices	Indirect Fire Weapons	Direct Fire Weapons	Forced Entry	Covert Entry	Visual Surveillance	Acoustic Eavesdropping	Electronic Emanations Eavesdropping	Airborne Contamination	Waterborne Contamination	Waterfront Attack
A	People	✓	✓	✓	✓	✓	✓	✓	✓			✓	✓	✓
B	Aircraft and Components at Aviation Facilities		✓	✓	✓	✓	✓	✓						
C	Ships, Boats, and Other Watercraft		✓	✓	✓	✓	✓	✓						✓
D	Vehicles and carriage mounted or towed weapons systems		✓	✓	✓	✓	✓	✓						✓
E	Petroleum, Oils, and Lubricants			✓	✓	✓	✓	✓						✓
F	Arms, Ammunition, and Explosives			✓	✓	✓	✓	✓						✓
G	Controlled Medical Substances and Medically Sensitive Items						✓	✓						
H	Communications / Electronics Equipment and Night Vision Devices			✓	✓	✓	✓	✓						
I	Organizational Clothing and Individual Equipment						✓	✓						
J	Subsistence Items at Commissaries, Warehouses, & Troop Issue Facilities						✓	✓						
K	Repair Parts at Installation Supply and Direct Support Units						✓	✓						
L	Facilities Engineering Supplies and Construction Material						✓	✓						
M	Audiovisual Equipment, Training Devices, and Subcaliber Devices						✓	✓						
N	Miscellaneous Pilferable Assets (other than above) and Money						✓	✓						
O	Critical Infrastructure and Utility Equipment		✓	✓	✓	✓	✓	✓						✓
P	Controlled Cryptographic Items						✓	✓						
Q	Sensitive Information						✓	✓	✓	✓	✓			
R	Activities and Operations	✓	✓	✓	✓	✓	✓	✓	✓	✓	✓	✓	✓	✓

Table 3-25. Applicable Aggressor / Tactic Selection

Aggressors	Applicable Tactics												
	Explosives Tactics			Standoff Weapons		Entry Tactics		Surveillance and Eavesdropping			Contamination Tactics		Waterfront Attack
	Moving Vehicle Devices Tactic	Stationary Vehicle Devices Tactic	Hand Delivered Devices	Indirect Fire Weapons	Direct Fire Weapons	Forced Entry	Covert Entry	Visual Surveillance	Acoustic Eavesdropping	Electronic Emanations Eavesdropping	Airborne Contamination	Waterborne Contamination	
Unsophisticated Criminals						L	L						
Sophisticated Criminals						L M H	L						
Organized Criminal Groups			L M		L M H	L M H VH	L						
Vandals			L		L	L	L						
Extremist Protesters			L M	L	L M H	L M	L M						L
Domestic Terrorists		L M	M H	L M	L M H	L M	L M H	H			L	L	L
International Terrorists	L M H	L M H	M H	L M H	L M H	L M H	L M H	H			L M	L M	L M
State Sponsored Terrorists	L M H VH	L M H VH	M H	L M H VH	L M H VH	M H VH	L M H VH	H			L M H	L M H	L M H
Saboteurs			M H	L M H VH	L M H VH	M H VH	L M H VH	H			L M H	L M H	L M H
Foreign Intelligence Services						L	H VH	H	H	H			

and fewer resources on assets that are less attractive to them. The Planning Team accepts the risk that this assumption is correct and that the aggressor does not attack at a higher threat severity level. If the Planning Team does not wish to accept the risk inherent in that assumption, they may choose to specify higher threat severity levels.

3-7.3.1 Select Applicable Threat Severity Levels. Table 3-25 indicates multiple threat severity levels for some aggressors for some tactics. Table 3-26 is used to determine which applies based on the aggressor likelihood ratings. To use Table 3-26, note how many possible threat severity levels apply for a specific aggressor in Table 3-25. Enter Table 3-26 on the left side with the number of possible threat severity levels (1, 2, 3, or 4,) and enter along the top of the table with the likelihood rating for the applicable aggressor. At the intersection of the two, read the number of the threat severity level that should be applied. Where only a “yes” is indicated in the table, there is only one threat severity level for that tactic, and any likelihood rating greater than 0.5 will mean that tactic and its single threat severity level apply. Enter the applicable threat severity level associated with the selection in the appropriate location on the Tactic, Threat Severity, and Level of Protection Worksheet as illustrated in Figure 3-5. Note that in Table 3-26 “minimum” is entered for likelihood ratings of less than or equal to 0.5. That indicates that minimum measures required by regulations or DoD or Combatant Command construction standards apply as described previously.

3-7.3.2 Example. As an example, assume the likelihood rating for international terrorists is 0.92. For the indirect weapons attack Table 3-25 indicates three possible choices for international terrorists, “low”, “medium”, and “high”. Entering Table 3-26 with 3 choices and a likelihood rating of 0.92 indicates that the “3rd” choice should be used. Therefore, the applicable threat severity level for that aggressor is “high.”

Table 3-26. Threat Severity Selection

Number of Threat Severity Level Choices *	Likelihood Rating				
	≤ 0.5	0.51 – 0.74	0.75 – 0.89	0.90 – 0.94	0.95 – 1
4	Minimum	1 st	2 nd	3 rd	4 th
3	Minimum	1 st	2 nd	3 rd	3 rd
2	Minimum	1 st	1 st	2 nd	2 nd
1	Minimum	1 st	1 st	1 st	1 st
* See Table 3-25					

3-8 **STEP 6: CONSOLIDATE INTO INITIAL DESIGN BASIS THREAT.** The initial design basis threat is the threat upon which the preliminary protective system will be based. It represents the worst-cases of the applicable threat severity levels for each applicable tactic for a given asset. The initial design basis threat may be changed during the design process based on detailed risk analysis as described in UFC 4-020-02. It will also be used to assess vulnerabilities in the case of existing facilities.

3-8.1 **Initial Design Basis Threat.** Determine the initial design basis threat by identifying the highest applicable threat severity level for each tactic across all aggressor types as entered on the Tactic Threat Severity, and Level of Protection Worksheet. Enter the initial design basis threat severity level for each tactic in the spaces provided at the bottom of the Tactic Threat Severity, and Level of Protection Worksheet. Refer to Table 3-27 to determine the design parameters (tools, weapons, explosives, and agents) associated with each of the threat severity levels for each tactic. In tactics with multiple threat severity levels, each threat severity level also includes the tools, weapons, explosives, and agents from lower threat severity levels. The threat severity levels will also be entered onto the Building Cost and Risk Evaluation Worksheet if that worksheet is used.

3-8.2 **Modifying the Initial Design Basis Threat.** The threat severity levels indicated are for generic aggressors in unspecified locations. If intelligence, experience, or the judgment of the Planning Team indicates that a different threat severity level applies based on known aggressor characteristics or site or asset specific considerations, those threat severity levels may be modified. In addition, if such considerations indicate that a specified tactic is inapplicable to threats against the asset under consideration, that tactic may be deleted from the threat. Also, if a Combatant Command standard indicates a specific threat, ensure that the initial design basis threat severity level is at least that which has design parameters equivalent to the threat associated with the Combatant Command threat. Ensure that the reasons for any change in the default threat severity levels are recorded for future reference.

Table 3-27 Threat Parameters

Aggressor Tactic	Design Basis Threat	Weapons	Tools Or Delivery Method
Moving and Stationary Vehicle Devices	Special Case ¹	9000 kg (19,800 lbs) TNT	18,000 kg / ~ 40,000 lbs truck
	Very High	2000 kg (4400 lbs) TNT, Fuel	7000 kg / ~ 15,000 lbs truck
	High	500 kg (100 lbs) TNT, Fuel	2500 kg / ~ 5500 lbs truck
	Medium	250 kg (550 lbs) TNT, Fuel	1800 kg / ~ 4000 lbs car
	Low	100 kg (220 lbs) TNT	1800 kg / ~ 4000 lbs car
	Very Low	25 kg (55 lbs) TNT	1800 kg / ~ 4000 lbs car
Hand Delivered Devices	High	IID, IED (up to 25 kg/55 lbs TNT) & hand grenades (Mail bomb limited to 1 kg/2.2 lbs TNT)	None
	Medium	IID, IED (up to 1 kg/2.2 lbs TNT) & hand grenades	
	Low	IID	
Indirect Fire Weapons Attack	Very High	Improvised mortar (up to 20 kg/44 lbs TNT)	None
	High	122 mm rocket	
	Medium	82 mm mortar	
	Low	Incendiary devices	
Direct Fire Weapons Attack	Very High	Light antitank weapons, and UL 752 Level 10 (12.7 mm (0.50 caliber), 1 shot)	None
	High	UL 752 Level 9 (7.62mm NATO AP, 1 shot)	
	Medium	UL 752 Level 5 (7.62mm NATO ball)	
	Low	UL 752 Level 3 (.44 magnum)	
Forced Entry	Very High	Handguns and sub-machine guns (up to UL 752 Level 3 to overpower guards)	Bulk explosives (up to 25 kg / 55 lbs TNT), linear shaped charges (up to 10,500grains per foot), unlimited hand, power, thermal tools
	High		Unlimited hand, power, and thermal tools
	Medium	None	Unlimited hand tools - limited battery powered tools
	Low	None	Limited hand tools - low observables
Covert Entry	Very High	Handgun	Electronic Neutralization Equipment Drill & Specialized Tools Robotic Dialer Manipulation Enhancer
	High	Handgun	Mechanical & Electronic Lock Decoder Drill, simple tools & camouflage Specialized bypass tools
	Medium	None	Lock Picks Bypass techniques High Quality False Credentials Observation tools
	Low	None	Easily Duplicated False Credentials

(Table 3-27 continued)

Visual Surveillance	High	None	Ocular devices
Acoustic Eavesdropping	High		Sound amplification or laser "listening" devices
Electronic Emanations Eavesdropping	High		Electronic emanations interception equipment
Airborne Contamination	High	Internal and external release of all agents listed below	Limited hand tools +1 kg/2.2 lbs explosive (dirty bomb)
	Medium	Agents associated with Low plus external release of toxic military chemical agents	Limited hand tools
	Low	Agents associated with Very Low plus external release of biological and radiological particulates	
	Very Low	External and internal release of Toxic Industrial Chemicals or Toxic Industrial Materials (TIC and TIM)	
Waterborne Contamination	High	Liquid or particulate agent stable in water greater than 30 days and not easily mitigated by chlorine	Limited hand tools
	Medium	Liquid or particulate agent stable in water between 2 hours and 30 days and not easily mitigated by chlorine	
	Low	Liquid or particulate agent stable in water less than 2 hours or easily mitigated by chlorine	
Waterfront Attack Surface and/or Submerged Attack	High	500 kg (1100 lbs) TNT (surface or submerged) Anti-Tank Weapons UL 752 Level 10 (12.7 x 99 mm (0.50 caliber))	Powerboat Multiple small craft Swimmer delivery vehicle Torpedo
	Medium	250 kg (550 lbs) TNT (surface) 25 kg (55 lbs) TNT (submerged) UL 752 Level 10 (12.7 x 99 mm (0.50 caliber))	Combat Rubber Raiding Craft Rigid Hulled Inflatable Boat Torpedo Swimmer / diver
	Low	100 kg (220 lbs) TNT (surface) 25 kg (55 lbs) TNT (submerged) UL 752 Level - 5	Jet Ski Swimmer / diver

1. Note that the process in this UFC does not lead to the Special Case. Applicability is known by those to whom it applies.

3-9 STEP 7: DETERMINE INITIAL LEVEL OF PROTECTION. Levels of protection reflect the degree to which an asset is protected against the threat based on its value to its user. A level of protection of "very high" corresponds to a low possibility that an asset will be compromised if attacked. For some tactics, level of protection refers to the amount of damage a facility or asset would be allowed to sustain in the event of an attack. A low amount of allowed damage equates to a high level of protection. For other tactics, level of protection refers to the probability that an aggressor will be defeated before the asset is compromised. A high probability of defeat equates to a high level of protection. There are one or more levels of protection ("very high", "high", "medium", "low", or "very low") for each of the 12 tactics, as shown in Table 3-28. The levels of protection are described for each tactic in Chapter 4. Levels of protection apply to all threat severity levels for each tactic. The initial level of protection may be changed during the design process based on detailed risk analysis as described in UFC 4-020-02.

3-9.1 **Initial Level of Protection.** For each asset, determine the initial level of protection for each applicable tactic with a design basis threat entry. Use Table 3-28 and the asset's value rating listed to select appropriate levels of protection. Enter the initial levels of protection in the appropriate spaces on the Tactic, Threat Severity, and Level of Protection Worksheet. Also enter them into the appropriate spaces on the Risk Level Calculation Worksheet and the Building Cost and Risk Evaluation Worksheet.

3-9.2 **Example.** For example, for the indirect fire weapons tactic for an asset with a value rating of 0.81, select the medium level of protection. Enter the level of protection for each applicable tactic on the Tactic, Threat Severity, and Level of Protection Summary Worksheet in the appropriate cell associated with each applicable tactic as illustrated in Figure 3-3. Also enter the levels of protection on the Risk Level Calculation Worksheet as illustrated in Figure 3-6 and on the Building Cost and Risk Evaluation Worksheet as illustrated in Figure 3-7.

3-9.3 **Modifying the Initial Level of Protection.** The level of protection determined using Table 3-28 is a default level. If the Planning Team determines that the level of protection selected for a tactic is too high or too low, they may modify it. However, lowering the level of protection may result in the asset being protected less than its value warrants with a higher risk of asset compromise. Conversely, raising the level of protection may result in greater protection than the asset value warrants, resulting in a greater cost for the protective system. The best basis for considering changes in levels of protection is to evaluate them based on cost and risk levels. That process is described in the next step of this process. Ensure that the reasons for any change in the default levels of protection are recorded for future reference.

3-10 **STEP 8: DETERMINE PLANNING RISK LEVELS.** Risk levels are used as a basis for comparing alternatives among levels of protection or countermeasures. Risk levels are based on asset values, aggressor likelihoods, and protection factors that reflect levels of protection provided to the assets. The risk analysis process in this UFC is for developing design criteria. A more detailed treatment of risk that considers the contribution of specific countermeasures is in UFC 4-020-02. Follow the steps below to determine risk levels. Risk levels will be determined from groups of tactics as described below and indicated on the Risk Level Calculation Worksheet illustrated in Figure 3-6. Note that risk in this UFC is a relative risk level that is intended to be used as an aid in decision making. Specific risk levels should not be used as goals or targets.

3-10.1 **Determine Threat Effectiveness Ratings.** The capabilities of aggressors to find weaknesses in security measures and to exploit them have a significant impact on risk, and it varies widely for different aggressors. Some of the questions used in determining aggressor likelihood ratings included considerations that were specific to aggressor types, but those considerations did not reflect how effective countermeasures were likely to be against the aggressors. They dealt with the likelihood that those aggressors would target an asset. Applying an effectiveness factor to adjust protection effectiveness accounts for how the sophistication, motivation, and risk acceptance of the aggressors affects the risk levels for the assets those aggressors

Table 3-28. Applicable Levels of Protection

Tactic	Threat Severity Level	Asset Value				
		≤ 0.5	0.51 – 0.74	0.75 – 0.85	0.86 – 0.95	0.96 - 1
Moving Vehicle Bomb	All	Very Low ¹	Low ²	Medium	High	
Stationary Vehicle Bomb		Very Low ¹	Low ²	Medium	High	
Hand Delivered Devices		Very Low ¹	Low ²	Medium	High	
Indirect Fire Weapons		Very Low ¹	Low	Medium	High	
Direct Fire Weapons	VH	Very Low ¹	Low	Medium ³	High	
	L, M, H	Very Low ¹	Low		High	
Forced Entry	All	Very Low ¹	Low	Medium	High	Very High
Covert Entry			Low	Medium	High	Very High
Visual Surveillance			High			
Acoustic Eavesdropping			Low	Medium	High	Very High
Electronic Emanations Eavesdropping			High			
Airborne Contaminants		Very Low ¹	Low	Medium	High	
Waterborne Contaminants		Very Low ¹	Low	Medium	High	
Waterfront Attack		Very Low ¹	Low	Medium ³	High	Very High
<ol style="list-style-type: none"> 1. The very low level of protection includes only measures required by UFC 4-010-01 minimum standards or other applicable standards, operations orders, or regulations. 2. The low level of protection is the minimum for those tactics that are addressed in UFC 4-010-01 for primary gathering buildings. Note also that while the moving vehicle bomb tactic is not expressly addressed in UFC 4-010-01, if it applies it should also be given the same minimum level of protection as the stationary vehicle bomb tactic for primary gathering buildings. 3. The medium level of protection commonly does not apply to ballistics below 12.7 mm (.50 caliber), which are the weapons in the low through high threat severity levels. For those threat severity levels, apply the low level of protection for this range of asset value ratings. 						

might target. Establishing threat effectiveness ratings is a complex task that requires significant intelligence resources. To expedite this procedure, the threat effectiveness ratings have been established as defaults for specific aggressor types.

3-10.1.1 Select Threat Effectiveness Ratings. Use Table 3-29 to determine the appropriate threat effectiveness ratings for the applicable aggressors. Enter the effectiveness ratings in the appropriate spaces in the Risk Level Calculation Worksheet as illustrated in Figure 3-6. The threat effectiveness ratings will be used in the risk equation to adjust the previously determined protection factors to reflect that a protective system that is highly effective against an unsophisticated aggressor may not be as effective against a highly sophisticated one.

Table 3-29. Threat Effectiveness Ratings

Aggressor Type	Effectiveness Rating (T_E)
Unsophisticated criminals	1.0
Sophisticated criminals	0.98
Organized criminal groups	0.95
Vandals	1.0
Extremist protest groups	0.96
Domestic terrorists	0.95
International terrorists	0.93
State sponsored terrorists	0.90
Saboteurs	0.90
Foreign intelligence services	0.91

3-10.1.2 Select Applicable Effectiveness Ratings for Aggressor Categories.

The threat effectiveness ratings will be used to adjust protection factors that are associated with each applicable tactic. For the purposes of the risk analysis the aggressors will be grouped into criminals, terrorists, saboteurs, and foreign intelligence services as indicated on the Risk Level Calculation Worksheet. Identify the threat effectiveness ratings associated with the aggressors with the highest likelihood rating for each of the applicable aggressor categories and enter them into the appropriate spaces on the Risk Level Calculation Worksheet. This entry is designated as T_{EH} .

3-10.2 Select Initial Protection Factors. Select the appropriate protection factor for each tactic based on the applicable level of protection using Table 3-30. These factors do not include any consideration of aggressor effectiveness. They only reflect the initial level of protection. These factors also do not reflect individual countermeasures. Instead, they are predicated on applying all of the countermeasures necessary to achieve a particular level of protection as tabulated in UFC 4-020-02. This assumption is appropriate for planning purposes. Consideration of individual countermeasures is left to the design process. Enter these factors in the appropriate spaces on the Risk Level Calculation Worksheet.

Table 3-30. Initial Protection Factors

Level of Protection	Protection Factor (P_I)
Very Low	0.1
Low	0.3
Medium	0.7
High	0.9
Very High	0.95

Figure 3-6. Sample Risk Level Calculation Worksheet

RISK LEVEL CALCULATION WORKSHEET																	
Project or Building:		Asset:					Analyst:										
A Motor Pool		Tactical vehicles					Jane Q. Planner										
Asset Value (Av):		Date:					Risk Level 7										
0.76		4 August 2008															
Aggressor	T _L ¹	T _E (Table 3-29)	Highest T _L (T ₁₀₀) ²	T _{EH} ³	Tactic	LOP ¹	P _I ⁴ (Table 3-30)	P _E ⁶ Aggressor Category			Risk Level 7						
								C	T	S	F	C	T	S	F		
Unsophisticated Criminals	.52	1.0	.54	.95	Moving Vehicle Bomb												
	.51	.98			Stationary Vehicle Bomb	M	.7	.7	.67	.63	.63	.14	.20	.14			
	.54	.95			Hand Delivered Devices	M	.7	.7	.67	.63	.63	.14	.20	.14			
Organized Criminal Groups	< .5				Explosives and Incendiaries												
	< .5				Indirect Fire Weapons	M	.7	.48	.45	.45	.30	.21					
Vandals	< .5				Standoff Weapons	L	.3										
	.57	.95			Direct Fire Weapons	M	.7	.67	.63	.63	.20	.14					
Extremist Protesters	.64	.93	.72	.90	Forced Entry	M	.7										
	.72	.90			Covert Entry	M	.7										
Domestic Terrorists	.51	.90	.51	.90	Visual Surveillance												
	.51	.90			Acoustic Eavesdropping												
International Terrorists	.72	.90			Electronic Emanations												
	.72	.90			Eavesdropping												
State Sponsored Terrorists	.51	.90	.51	.90	Surveillance and Eavesdropping												
	.51	.90			Airborne Contamination												
Saboteurs (S)	.51	.90	.51	.90	Waterborne Contamination												
	.51	.90			Waterfront Attack												
Foreign Intelligence Services (F)	.72	.90															
	.72	.90															

1. From Tactic, Threat Severity, and LOP Worksheet.
 2. Highest likelihood rating for each aggressor group.
 3. Effectiveness rating for aggressor with highest likelihood.
 4. From Table 3-30.
 5. Average for P_I for all tactics within tactic group.
 6. P_E = T_{EH} x P_{I,AVG} for each aggressor & tactic group combination.
 7. R = A_V x T_{EH} x (1-P_E) for each aggressor & tactic group.

3-10.3 **Calculate Average Initial Protection Factors.** Risk levels are calculated for tactic groups instead of individual tactics to minimize the number of risk levels to be evaluated. An initial protection factor must, therefore, be determined for each tactic group. Use the average of the initial protection factors for each tactic group. Enter the average for each group into the applicable space on the Risk Level Calculation Worksheet. This entry is designated as P_{IAVG} .

3-10.4 **Adjust Initial Protection Factors.** Adjust the average initial protection factors to reflect threat effectiveness ratings. Determine effective protection factors for each applicable tactic. Enter the applicable threat effectiveness ratings (T_{EH}) for each of the applicable aggressor categories associated with the applicable average initial protection factors (P_{IAVG}) into Equation 3-1. The applicable aggressor categories for each tactic are those to whom those tactics apply as identified on the Tactic and Threat Severity Level Worksheet. For example, if the indirect fire weapons tactic was determined to be part of the initial design basis threat based on consideration of terrorists, use the applicable threat effectiveness rating for terrorists to determine the effective protection factor for that tactic using Equation 3-1. Where multiple aggressor categories are applicable to a given tactic, calculate a separate effective protection factor for each aggressor group. Enter the effective protection factors (P_E) in the appropriate spaces in the Risk Level Calculation Worksheet.

$$\text{Equation 3-1. } P_E = T_{EH} \times P_{IAVG}$$

3-10.5 **Determine Risk Level.** Calculate risk levels for each asset and for each applicable tactic group and aggressor group as indicated on the Risk Level Calculation Worksheet. Risk levels are established by entering the likelihood and asset value ratings and the protection effectiveness factors into Equation 3-2. By subtracting P_E from 1, the risk equation reflects the fact that increases in protection effectiveness reduce risk. The $1 - P_E$ term reflects "vulnerability".

$$\text{Equation 3-2. } R = A_V \times T_{LH} \times (1 - P_E)$$

3-10.5.1 **Asset Value Ratings.** Enter the asset value ratings (A_V) for each asset into the risk equation for each applicable tactic group.

3-10.5.2 **Likelihood Ratings.** Enter the highest likelihood ratings (T_{LH}) for each applicable aggressor group associated with each applicable tactic group as identified on the Tactic and Threat Severity Worksheet. Use the likelihood rating for the aggressor group that includes the aggressors who were used to establish the applicability and threat severity levels for that tactic group. For example, terrorists would commonly be the aggressors upon whom the applicability and threat severity levels for explosives tactics are based. Therefore, to determine the risk level for the explosives tactics, enter the highest likelihood rating for the terrorist aggressor group. Where there are multiple aggressor categories that were used to establish applicability and threat severities for a particular tactic group, calculate a separate risk level for each group.

3-10.5.3 **Protection Effectiveness factors.** Enter the protection effectiveness factor for each applicable tactic group and for each applicable aggressor group.

3-10.5.4 **Risk Level.** Enter the risk levels calculated using Equation 3-2 in the appropriate spaces on the Risk Level Calculation Worksheet.

3-11 **STEP 9: ASSESS ACCEPTABILITY OF RISK LEVELS.** There are no specific criteria for determining whether or not a given risk level is acceptable. In some cases the Planning Team may have a goal for a risk level, although that is not recommended. In other cases the costs for achieving a level of protection associated with a risk may be the basis for a risk being acceptable. Because the risk levels in this UFC are relative, their best use is as an aid in decision making. The risk level means relatively little in itself, but when the reduction in risk can be evaluated with respect to the cost of a protective system, that provides a rough means of evaluating benefit versus cost. The benefit is the reduction in risk. For example, if a large expenditure for countermeasures results in a very small reduction in risk, that may not be a good investment. On the other hand, when a small expenditure for countermeasures results in a large reduction in risk, that may be a good investment. Evaluating risk versus cost in that manner provides a basis for evaluating various alternatives.

3-11.1 **Cost and Risk Evaluation.** The Building Cost and Risk Evaluation Worksheet is provided to assist in evaluating changes in risk levels due to changes in threat severity levels or levels of protection. It has spaces for initial and revised conditions for threat severity levels, levels of protection or protection factors, risk levels, and cost increases. It also has spaces that support analysis of the differences between the initial and revised conditions. Those spaces include change in cost, change in risk, and the ratio of the two. Note that changes to threat severity levels will intuitively impact risk due to changes in the design basis threat, but those impacts are not captured in the risk calculation. Use one worksheet for each asset and for each option evaluated to ensure there is a "paper trail" for each option. Use the Risk Level Calculation Worksheet to evaluate the effects of changes in levels of protection or protection factors on risk levels.

3-11.1.1 **Risk Levels.** Enter risk levels for each tactic group on the Building Cost and Risk Evaluation Worksheet. In cases where there are multiple aggressors to whom tactics within a tactic group apply, use the risk level for the aggressor whose threat severity level is the basis for the design basis threat on the Tactic, Threat Severity, and Level of Protection Worksheet.

For example, in Figure 3-5, the forced and covert entry tactics apply to criminals, terrorists, and saboteurs, but the threat severity level for the terrorists is the basis for the design basis threat. In that case, the risk level for terrorists from the Risk Level Calculation Worksheet would be entered for the entry tactics on the Building Cost and Risk Evaluation Worksheet.

3-11.1.2 **Cost Increases.** To determine the costs of initial protective systems for planning purposes refer to Chapter 6 and Appendices A through C. Note that those

costs are based on applying all the applicable countermeasures to achieve a particular level of protection. A more detailed treatment of cost and risk that considers the contribution of individual countermeasures is presented in UFC 4-020-02.

Enter the cost increases for each applicable tactic. In cases such as the hand delivered devices tactic, there are separate entries for different applications of that tactic (building exterior, mail rooms, loading docks, and entry areas). In those cases, enter cost increases for each applicable application.

Sum the costs for all applicable tactics and applications within each tactic group with the following exception. Because the construction to mitigate the effects of the vehicle bomb tactics and exterior application of the hand delivered devices tactic is similar, where more than one of those tactics applies, use the cost of the most expensive to represent all three rather than adding them together. All other tactics and applications should be additive. Note that the construction necessary to provide protection against some tactics is very similar to that for other tactics, which means that summing all the applicable costs as described above may be conservative due to potentially accounting for similar upgrades more than once. For example, walls to resist vehicle bombs may be adequate for resisting indirect fire weapons effects and windows to resist small arms may be effective for blast resistance. Accounting for such redundancy is very complex; therefore, it is beyond the scope of this UFC. It can be dealt with during design.

3-11.2 Cost and Risk Analysis. Use the analysis columns of the Building Cost and Risk Evaluation Worksheet to evaluate risk and cost changes. Enter the difference between the cost increases for the initial and revised conditions in the appropriate spaces on the Building Cost and Risk Evaluation Worksheet. Do the same for the changes in risk levels. Finally, enter the ratio of change in risk to change in cost. Note that the entries in the analysis columns are by tactic groups.

3-11.2.1 Unacceptable Cost and Risk. If the cost and risk are determined by the Planning Team to be unacceptable, for the purposes of planning, revise the level of protection, rerun the risk level calculation, and re-evaluate the acceptability of the risk. Alternatively, the team may modify threat severity levels for individual tactics and make similar adjustments.

3-11.2.2 Acceptable Cost and Risk. If the cost and risk are determined by the Planning Team to be acceptable, incorporate the design criteria developed using this procedure into the planning documents as requirements for the project design. Use the Design Criteria Summary Worksheet to record the design criteria, which will include the assets to be protected, the threats to those assets (tactics with associated threat severity levels), and the levels of protection to which those assets are to be protected. Recall that the design criteria also includes design constraints that might be imposed by the Planning Team, which is the subject of the next and final step of this process.

Figure 3-7. Sample Building Cost and Risk Evaluation Worksheet

BUILDING COST AND RISK EVALUATION WORKSHEET														
Project or Building		Asset			Analyst			Date			Analysis			
A Motor Pool		Tactical Vehicles			Jane Q. Planner			4 August 2008			Change ¹¹ in Cost (%)	Ratio ¹²		
		Baseline Building Category (Table 3-1)			Special Structure			Change ¹¹ in Risk (%)	Ratio ¹²					
Tactic	Initial				Revised				Analysis					
	Design Basis Threat ¹	LOP ^{2,4} or P _T	Risk ⁷ Level	Standoff, Rm. Size, Stories, %	Cost ⁸ Increase (%)	Cost ⁸ Incr. Sum	Threat Severity Level	LOP ^{2,4} or P _T	Risk ⁷ Level	Standoff, Rm. Size, Stories, %	Cost ⁸ Increase (%)	Cost ⁸ Incr. Sum	Change ¹¹ in Cost (%)	Ratio ¹²
Explosives and Incendiaries	Moving Vehicle Bomb 1		(T)			17.1	M		(T)			6.5	-62	-64
	Stationary Vehicle Bomb 1	L	M	.20	25 m	17.1			.28	25 m	6.5			
	Hand Delivered Devices													
	• Exterior ¹	M	M		10 m	1.7				10 m	1.7			
	• Mail Room ⁶													
	• Loading Dock ⁶													
	• Entry Area ⁶													
Standoff Weapons	Indirect Fire Weapons	L	M	(T)		2.17	M		(T)		1.8	2.17	0	+40
	Direct Fire Weapons	L	L	.30		0.37			.28		0.37			
Entry Tactics	Forced Entry			(T)		1.8			(T)			1.1	-39	-1.02
	• Exterior													
	• Interior ⁶	M	M	.20	large	0.35			.28	large	0.12			
	Covert Entry	L	M			0.5					0.1			
Surveillance and Eavesdropping	Visual													
	Surveillance													
	Acoustic Eavesdropping													
	• Exterior													
	• Interior ⁶													
	Electronic Emanations Eavesdropping													
	• Exterior													
	• Interior ⁶													
Contamination	Airborne Contamination													
	Waterborne Contamination													
	Waterfront Attack													
				Sum ¹⁴ (%)				Sum ¹⁴ (%)				Sum ¹⁴ (%)		
				21.07				9.77				9.77		

1. Use highest cost among these tactics
 2. From Tactic, Threat Severity and LOP Worksheet
 3. Level of Protection or Initial Protection Level
 4. From Risk Level Calculation Worksheet
 5. One risk level for each tactic group
 6. Risk level for aggressor whose threat severity level controls DBT (from Tactic, Threat Severity, and LOP Wksht)
 7. Indicate which aggressor controls
 8. From Appendix A or B or from other cost estimate
 9. Enter small, medium, or large room
 10. Enter percentage of building perimeter protected
 11. (Revised cost sum - initial cost sum) ÷ initial cost sum
 12. (Revised risk level - initial risk level) ÷ initial risk level
 13. Change in risk ÷ change in cost
 14. Total building cost increase (w/o progressive collapse)

3-12 **STEP 10: IDENTIFY USER CONSTRAINTS.** User constraints include physical characteristics and qualities or operational considerations that restrict or dictate the design of a protective system. During design criteria development the Planning Team considers non-technical constraints relating to user requirements. As part of the design of the protective system the designers may identify more technical design constraints related to specific countermeasures. User constraints are specific to an asset, a facility, a site, an entire installation, or a city. Installation master planning requirements and facility design criteria unrelated to security often constrain protective system design. Consider the following categories of constraints to the extent that they apply to the individual project. List the user constraints and describe them in a narrative to be included with the design criteria documents.

3-12.1 **Political Considerations.** The relationship between the military and the public, including personnel on or off the installation, may influence design. Evaluate the following:

3-12.1.1 **Adjacent Landowners or Other Tenant Organizations.** Assess potential problems such as the impact of high-intensity security lighting or traffic restrictions. Identify any neighbors requiring special consideration.

3-12.1.2 **Appearance.** Consider public perception of the appearance of a proposed secure facility, site, or area. For example, public perception of a “fortress” may be either desirable or undesirable depending on the intent of the Planning Team. Such facilities may provide deterrence. They may also be perceived negatively.

3-12.1.3 **Public Access.** Identify restrictions on limiting public access to a facility, a site, or an area of an installation.

3-12.1.4 **Political Climate.** Consider how the local political situation influences facility design or land use decisions. Politically unpopular decisions may attract acts of aggression to completed facilities.

3-12.2 **Financial Considerations.** Identify funding limitations for security based on such criteria as policy, available funds, asset value, or the Planning Team’s judgment of a reasonable limit for security costs. Describe limitations in terms of actual cost or percentage of facility cost. In defining an acceptable cost, consider all costs of replacing the asset and costs of operating without it.

3-12.3 **Regulations.** Ensure that all pertinent regulations are cited to ensure that the designers consider them. Also consider requirements imposed by the installation’s physical security and antiterrorism plans.

3-12.4 **Procedural or Operational Considerations.** Installation or facility user requirements related to operations in either normal or heightened Force Protection Conditions (FPCON) may constrain design. If there are specific user constraints related to procedures and operations, ensure they are communicated to the designers so they do not make conflicting recommendations as part of their protective system design. A

protective system must comprise an integration of construction, building support systems, equipment, manpower, and procedures. Examples of applicable procedures and operations include the following:

3-12.4.1 **Deliveries.** Identify specific existing or planned requirements for how deliveries or pickups are to be made. Consider mail, supplies, materiel, and trash. Include limitations on where deliveries or pickups may be made. Also consider service or construction vehicles.

3-12.4.2 **Restricted Areas.** Identify areas within facilities or within the installation that require restricted access and state the scope of the restriction. Consider also how existing access limitations may impact design or construction.

3-12.4.3 **Access Controls.** Identify who or what is to be controlled, to what degree, and where and when the controls apply. Include personnel identity and weapons checks, vehicle checks, and checks of packages for such items as explosives or classified information.

3-12.4.4 **Functional Requirements.** Determine how the user will operate the facility and identify constraints related to operation. Include functional relationships between organizations or components of organizations, work schedules, types of operations to be performed, and special requirements for facility layout or construction.

3-12.5 **Facility and Site Constraints.** Examine the installation's master plan, existing facilities, and any plans or sketches for the proposed project. Identify requirements related to site or facility layout or construction. Potential constraints include the following:

3-12.5.1 **Occupancy Requirements.** Identify any special space requirements, window ratios, and other occupancy-related design constraints.

3-12.5.2 **Barrier-Free Accessibility.** Public facilities and facilities which may shelter or be used by military dependents or civilians must conform to the guidelines found in the *Uniform Federal Accessibility Standards* which may constrain security-related design.

3-12.5.3 **Parking Lots and Roads.** Identify specific requirements for parking lots and roads that could impact security. Consider, for example, how close to the protected building vehicles must be allowed to approach or park (with and without entry control) for operational purposes.

3-12.5.4 **Fences and Lighting.** Identify specific requirements or restrictions for installation of fences or security lighting.

3-12.5.5 **Electronic Security Systems.** Identify specific requirements for electronic security systems including CCTV, electronic entry control equipment unrelated to the threats identified in this process.

3-12.5.6 **Architectural Theme.** Identify requirements or restrictions on the construction materials or architectural style to be used for the building. Some installations provide architectural guidelines that define appropriate styles and limit construction materials.

3-12.5.7 **Existing Facilities.** Determine whether layout, proximity, construction, or operations of existing facilities constrain new projects.

3-12.5.8 **Miscellaneous.** Determine design constraints imposed by landmark status of buildings or areas, floodplain restrictions, endangered wildlife or plant species, or any other design considerations that can be addressed at this stage of project development.

3-12.6 **Response Force.** Identify the response forces that would respond to an act of aggression. The design of a protective system assumes the response force is capable of neutralizing the threat. Consider the following with respect to whether or not such forces are available for integration into the protective system:

3-12.6.1 **Armed Force.** Department of Defense civilian police or security guards, military or security police, troops, and special reaction teams may respond to detected attacks.

3-12.6.2 **Explosive Ordnance Disposal (EOD) Team.** When acts of aggression involve explosives, an EOD team may attempt to dispose of the explosives before detonation.

3-12.6.3 **Fire Department.** The fire department responds to support the EOD team, responds after a successful attack to contain fire damage and rescue victims, and may constitute the first responders to a chemical, biological, or radiological attack.

3-12.7 **Response Time.** The time required for a force to detect and assess an act of aggression and to reach a facility in response to the act is the response time. Response time has direct design implications only in the forced entry tactic, for which it is important because it determines the length of time building elements must delay an aggressor to allow an adequate response. . For certain assets, regulations specify maximum response times.

3-12.8 **Manpower Allocation.** Identify available security personnel that can be integrated into the protective system or positions to be eliminated. Consider the personnel listed below.

- Command and control center personnel or IDS operators.
- Entry/access control guards.
- Fixed post guards.
- Roving guards.

3-13 **INFORMATION SENSITIVITY.** Information generated by the Planning Team as output from the planning procedure indicates the assets the user considers important and the threats against which the protective system is designed. This is sensitive information and will be treated as "For Official Use Only" as a minimum. This applies to completed forms and to other documentation that reflects the sensitive information on the forms. The information will be considered for classification at an appropriate level when either of the following criteria exists:

3-13.1 **Derivative Classification.** If classified information is used in generating the output of this procedure, the resulting information may need the derivative classification of the material from which it was derived.

3-13.2 **Classification Guides.** For some situations, there may be a classification guide that governs the classification of information relating to that situation. Where there are such guides, they may govern classification of elements if the design criteria.

3-13.3 **Original Classification.** Capabilities or design parameters must be protected for operational security reasons. Operational security is especially relevant for overseas projects constructed in high-threat areas and for mission-essential facilities. The installation commander or a designated representative with original classification authority should determine the appropriate classification level to protect the facility design information.

CHAPTER 4

DESIGN STRATEGIES – WEAPONS AND EXPLOSIVES TACTICS

4-1 **INTRODUCTION.** The approaches to mitigating the effects on assets from any of the tactics described in this UFC are referred to as design strategies. It is not intended for planners to apply these design strategies in a detailed manner, but planners should understand how the design strategies affect the designs of facilities. With that understanding, planners can explain the basis for the costs associated with protecting against a given tactic as reflected in the cost increase appendices in this UFC. This chapter, therefore, describes the design strategies as well as summarizes the likely impacts on construction that will result from the application of those strategies. There are two levels of design strategies associated with each tactic, the general design strategy and the specific design strategy. Both levels of design strategies will be described for each tactic.

4-1.1 **General Design Strategy.** The general design strategy for any tactic is the basic approach to developing a protective system to mitigate the effects of that tactic. It governs the general application of construction, building support systems, equipment, manpower, and procedures.

4-1.2 **Specific Design Strategy.** The specific design strategy for any tactic governs how the general design strategy varies for different levels of protection. The specific design strategies and their nature vary with each tactic. They may vary by the sophistication of the protective measures, the degree of protection provided, or the degree of damage a building will be allowed to sustain, among others. The specific design strategies reflect the degree to which assets will be left vulnerable after the protective system has been employed.

4-1.3 **Project Scope Implications.** Because this UFC is intended to support project planning, it does not include detailed discussions on protective measures. Planners must have a basic understanding of the implications on project scopes of application of the design strategies for various levels of protection and tactics, however. To support that understanding, brief summaries of the types of protective measures that can be expected are provided for each tactic. Those summaries are only intended to aid in understanding the basis for the cost increases in the cost appendices. More detailed discussions of protective measures are included in the *DoD Security Engineering Facilities Design Manual (UFC-4-020-02)*. The protective measures are divided into the categories below. Not all categories apply to all tactics.

4-1.3.1 **Sitework Elements.** These include all protective measures that are associated with areas surrounding buildings beyond 1.5 m (5 ft) from the building, excluding measures that are included under equipment. Commonly these will include such measures as fences, barriers, and landscaping.

4-1.3.2 **Building Elements.** These include all protective measures directly associated with buildings such as walls, doors, windows, roofs, superstructure, and building layout.

4-1.3.3 **Building Support Systems.** For the purposes of this UFC, building support systems will include those systems that are necessary to make the building operate on a day-to-day basis. The heating, ventilating, and air conditioning (HVAC) system is the primary such system addressed in this UFC.

4-1.3.4 **Equipment.** For the purposes of this UFC, equipment will include protective measures such as intrusion detection systems, electronic entry control systems, closed circuit television systems, and other electronic systems that support functions such as access control and detection of aggressors or tools, weapons, explosives, and agents.

4-1.3.5 **Manpower and Procedures.** While these are not engineering or architectural issues, they may have impact on the overall engineering and architecture of projects. The availability of manpower and the procedures that are in place may also affect the form of the protective system and, therefore, its cost. Manpower includes the guards or operators needed to operate whatever systems are provided or to provide functions such as access control and the response forces that are needed to respond to an act of aggression.

4-1.3.6 **Expeditionary and Temporary Construction Considerations.** The general and specific design strategies that apply to permanent construction also apply to expeditionary and temporary construction, but the forms of the protective measures may be somewhat different. For each tactic, the expeditionary and temporary construction considerations will address those differences.

4-2 **VEHICLE BOMB TACTICS.** Both the general and specific design strategies for the moving and stationary vehicle bomb tactics are the same. Only the details of the application of the countermeasures change.

4-2.1 **General Design Strategy.** The general design strategy for these tactics comprises four elements, standoff distance, building hardening, barriers, and manpower and procedures.

4-2.1.1 **Standoff Distance.** The pressures resulting from explosive blasts can be very high, but they decrease rapidly with distance (proportional to the cube root of the distance.) That suggests that where land is available the least expensive way to provide protection against explosives is to maximize the standoff distance. The general design strategy, therefore, is to provide as much standoff distance between protected facilities and potential locations for vehicles, such as parking areas, roadways, and other locations that could be accessible by vehicles. The only difference in the application of this strategy for moving vehicle bombs versus stationary vehicle bombs with respect to standoff distance is that the locations to be considered for the stationary vehicle bomb can be limited to those where parking or other vehicle access is common.

The reason for that is the assumption that the aggressors who would employ the stationary vehicle bomb seek to be covert as described in chapter 2. In the case of the moving vehicle bomb, that assumption is invalid because the aggressors are assumed to be suicidal. Detection is assumed not to be a deterrent to them.

4-2.1.2 **Building Hardening.** Where the standoff distance from a vehicle bomb to a protected facility is sufficient, the facility can be of conventional construction, which means that it can be built without any hardening of building elements. One major exception to that is windows, which would have to be constructed to minimize fragmentation as reflected in the windows required by the *DoD Minimum Antiterrorism Standards for Buildings (UFC 4-010-01)*. Where the sufficient standoff distances cannot be provided, building elements such as walls, doors, windows, roofs, and, potentially, building superstructures may have to be hardened to resist the explosive effects to the applicable level of protection. The cost tables in Appendices A and B account for building hardening where appropriate.

4-2.1.3 **Vehicle Barriers.** The general design strategy for both of these tactics includes the application of some form of vehicle barriers to establish and maintain the standoff distance between vehicles and facilities. Those barriers will commonly include passive perimeter barriers that define the standoff distance and active barriers that allow entry through the perimeter. For the stationary vehicle bomb tactic, both the passive perimeter and active barriers only need to define the perimeter and provide an obstacle whose breaching would draw attention. For the moving vehicle bomb tactic those barriers must actually stop the kinetic energy of the moving vehicle because the driver is assumed to be suicidal.

4-2.1.4 **Manpower and Procedures.** The general design strategy also depends on manpower and procedures. While those are not an engineering issue, because they are an integral part of the protective system necessary for mitigating these tactics, they must be incorporated in the design. That will require coordination with the operations or security people associated with each project, who ultimately will establish manpower requirements and define the procedures based on local considerations. The manpower and procedures support the general design strategy in controlling access closer to the facility than the standoff distance.

4-2.2 **Specific Design Strategies.** The specific design strategies for these tactics reflect differences in how protective measures are applied for different levels of protection. Those differences may manifest themselves in differing standoff distances or differences in the construction of building elements for different levels of protection. The general goals for manpower and procedures also vary with levels of protection. Barrier requirements commonly do not, however. The design goals associated with the various level of protection are reflected in Tables 4-1 and 4-2 for new and existing construction and expeditionary and temporary construction, respectively. Table 4-3 summarizes the manpower and procedures goals that are associated with each level of protection for new and existing buildings and for expeditionary and temporary construction.

Table 4-1 Levels of Protection – New and Existing Buildings

Level of Protection	Potential Building Damage / Performance ²	Potential Door and Glazing Hazards³	Potential Injuries
Below Very Low¹	Severe damage. Progressive collapse likely. Space in and around damaged area will be unusable.	Doors windows will fail catastrophically and result in lethal hazards. (High hazard rating)	Majority of personnel in collapse region suffer fatalities. Potential fatalities in areas outside of collapsed area likely.
Very Low	Heavy damage - Onset of structural collapse, but progressive collapse is unlikely. Space in and around damaged area will be unusable.	Glazing will fracture, come out of the frame, and is likely to be propelled into the building, with the potential to cause serious injuries. (Low hazard rating) Doors may be propelled into rooms, presenting serious hazards.	Majority of personnel in damaged area suffer serious injuries with a potential for fatalities. Personnel in areas outside damaged area will experience minor to moderate injuries.
Low	Moderate damage – Building damage will not be economically repairable. Progressive collapse will not occur. Space in and around damaged area will be unusable.	Glazing will fracture, potentially come out of the frame, but at a reduced velocity, does not present a significant injury hazard. (Very low hazard rating) Doors may fail, but they will rebound out of their frames, presenting minimal hazards.	Majority of personnel in damaged area suffer minor to moderate injuries with the potential for a few serious injuries, but fatalities are unlikely. Personnel in areas outside damaged areas will potentially experience a minor to moderate injuries.
Medium	Minor damage – Building damage will be economically repairable. Space in and around damaged area can be used and will be fully functional after cleanup and repairs.	Glazing will fracture, remain in the frame and results in a minimal hazard consisting of glass dust and slivers. (Minimal hazard rating) Doors will stay in frames, but will not be reusable.	Personnel in damaged area potentially suffer minor to moderate injuries, but fatalities are unlikely. Personnel in areas outside damaged areas will potentially experience superficial injuries.
High	Minimal damage. No permanent deformations. The facility will be immediately operable.	Glazing will not break. (No hazard rating) Doors will be reusable.	Only superficial injuries are likely.
<p>Notes:</p> <ol style="list-style-type: none"> 1. This is not a level of protection, and should never be a design goal. It only defines a realm of more severe structural response, and may provide useful information in some cases. 2. For damage / performance descriptions for primary, secondary, and non-structural members, refer to UFC 4-020-02. 3. Glazing hazard levels are from ASTM F 1642. 			

Table 4-2 Levels of Protection – Expeditionary and Temporary Structures

Level of Protection	Potential Structural Damage	Potential Injuries
Below Very Low	Severe damage. Frame collapse/massive destruction. Little left standing.	Majority of personnel in collapse region suffer fatalities. Potential fatalities in areas outside of collapsed area likely.
Very Low	Heavy damage. A majority of the structure will collapse and a majority of secondary structural members will collapse.	Majority of personnel in damaged area suffer serious injuries with a potential for fatalities. Personnel in areas outside damaged area will experience minor to moderate injuries.
Low	Moderate damage. Damage will be unrepairable. Some sections of the structure may collapse or lose structural capacity.	Majority of personnel in damaged area suffer minor to moderate injuries with the potential for a few serious injuries, but fatalities are unlikely. Personnel in areas outside damaged areas will potentially experience a minor to moderate injuries.
Medium	Minor damage. Damage will be repairable. Minor to major deformations of both structural members and non-structural elements. Some secondary debris will be likely, but the structure remains intact with collapse unlikely.	Personnel in damaged area potentially suffer minor to moderate injuries, but fatalities are unlikely. Personnel in areas outside damaged areas will potentially experience superficial injuries.
High	Minimal damage. No permanent deformation of primary and secondary structural members or non-structural elements.	Only superficial injuries are likely.

Table 4-3. Manpower and Procedures Goals for Vehicle Bomb Tactics

Level of Protection	Manpower and Procedures Goals
Below Very Low	None
Very Low	Driver and vehicle authorization checked and visible areas of vehicles checked visually
Low	Driver and vehicle authorization and visual check of visible areas of all vehicles plus visual check of cargo areas or trunks for random number of vehicles
Medium	Driver and vehicle authorization and visual check of visible areas of all vehicles plus comprehensive search of random number of vehicles.
High	Driver and vehicle authorization plus comprehensive search of all vehicles.

4-2.3 Project Scope Implications.

4-2.3.1 **Sitework Elements.** The impacts on project planning for sitework elements include standoff distance and barriers to establish and maintain that standoff distance.

4-2.3.1.1 **Standoff Distance.** The primary impact on project scope for sitework will be the establishment and maintenance of standoff distance. That standoff will have to be provided to any location that is accessible to vehicles. For the stationary vehicle bomb tactic those locations may be limited to those that have legitimate vehicle access such as parking areas and roadways. For the moving vehicle bomb tactic those locations will need to go beyond the areas that are legitimately accessible to vehicles and include those that are physically accessible.

The key to understanding the planning implications of the standoff distance is in knowing the type of vehicle and the explosive weight associated with the threat and determining where access of those vehicles will be controlled. Refer to Table 3-27 for the vehicles and explosive weights associated with the various threat severity levels. In addition, planners need to recognize that where a higher threat severity level applies, all those below it also apply. One approach, therefore, is to establish a standoff distance based on the largest applicable explosive weight based on the applicable threat severity level and require access procedures for entry past that perimeter to be applied to all vehicles at that standoff distance. In cases where the threat severity level is equal to or greater than "high" (where the threat vehicles are trucks), all vehicles would be required to be searched at that standoff distance. The operational implications of that requirement may be impractical in most locations.

Those operational challenges suggest another option for application at higher threat severity levels. That option capitalizes on the fact that trucks are assumed to carry more explosives than cars and recognizes that there are usually more cars than trucks that require access near facilities. The approach of this second option is to create a two tiered system of standoff distances where trucks are controlled at the standoff distance associated with the highest applicable threat severity level and a second tier of standoff distances is established within that outer perimeter at a distance associated with the largest explosive weight cars are assumed to carry, which is 100 kg (220 lbs). Note that where threats larger than 100 kg (220 lbs) apply, all threats smaller than them also apply. With the option of establishing two separate perimeters, trucks can be searched at the greater standoff distance and cars can be allowed to go up to the closer standoff distance before they have to be controlled and searched. This approach minimizes the operational challenges of searching all vehicles at the standoff distance associated with trucks. The perimeter associated with the higher explosive weight could be a controlled perimeter as described in UFC 4-010-01. It can be anywhere the installation operations and security personnel wanted to establish access control, including the installation perimeter. The option described above is illustrated in Figure 4-1. Note that in Figure 4-1, either of the perimeters can be anywhere as long as they provide the appropriate standoff distance for the building construction.

Figure 4-1. Standoff Zones

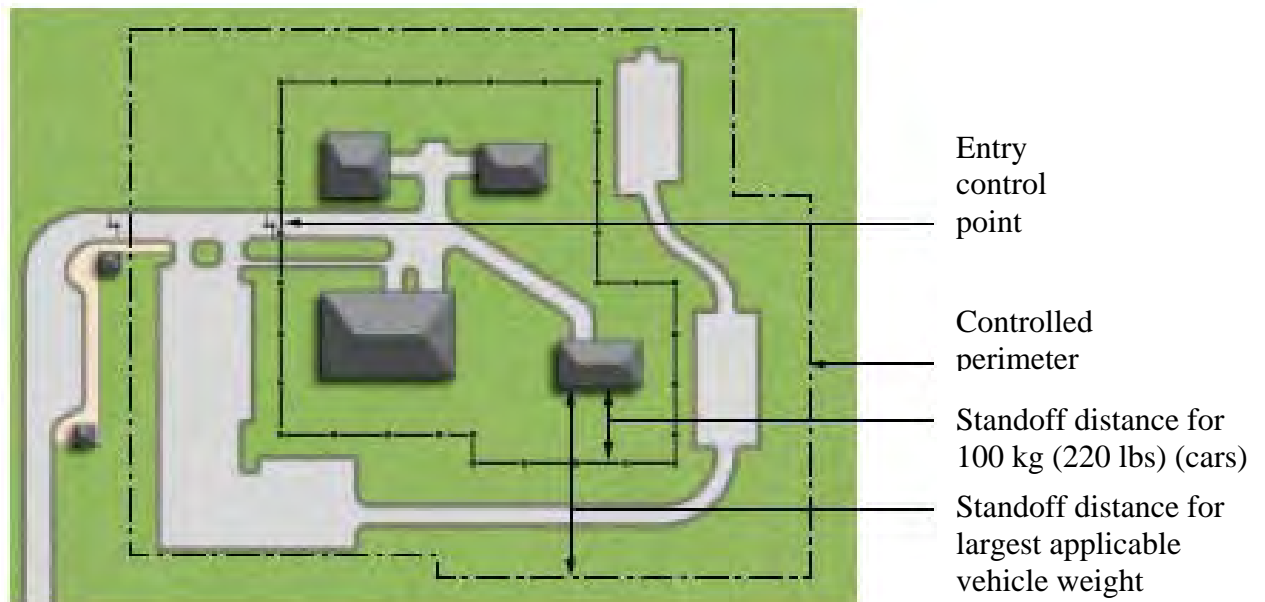

4-2.3.1.2 **Vehicle Barriers.** Vehicle barriers are part of the design strategy for both vehicle bomb tactics and for all levels of protection. Vehicle barriers will include both passive perimeter barriers and active vehicle barriers that are applied at entries through the passive perimeter barriers. Their application differs significantly for the moving and stationary vehicle bomb tactics, however. Note also that to be effective barriers need to span the entire perimeter and all entries through it. They do not need to all be the same, but they do need to meet the same requirements as described below.

Active and passive perimeter barriers for the stationary vehicle bomb tactic only need to present an obstacle that would draw attention to the drivers of vehicles as they breached them. Examples of passive perimeter barriers that would satisfy the design strategy are high curbs, shrubbery, and unreinforced fences as shown in Figure 4-2. Examples of satisfactory active barriers would be chains draped between poles and drop arm barriers such as those found commonly in commercial parking lots as shown in Figure 4-4.

Active and passive perimeter barriers for the moving vehicle bomb tactic need to be able to stop the full kinetic energy of the threat vehicle. The construction of those barriers will vary significantly based on the weight of the loaded threat vehicles and the speed they can attain. Passive perimeter barriers range from reinforced fences to heavily reinforced retaining walls such as those shown in Figure 4-3. There is a wide range of possible solutions that engineers and landscape architects can develop for passive perimeter barriers. Active barriers will commonly include retractable bollards, pop-up plate or drum barriers, and reinforced sliding gates such as those shown in Figure 4.5. They all need to have been tested to resist the threat vehicle.

Figure 4-2. Passive Perimeter Barriers for Stationary Vehicle Bombs

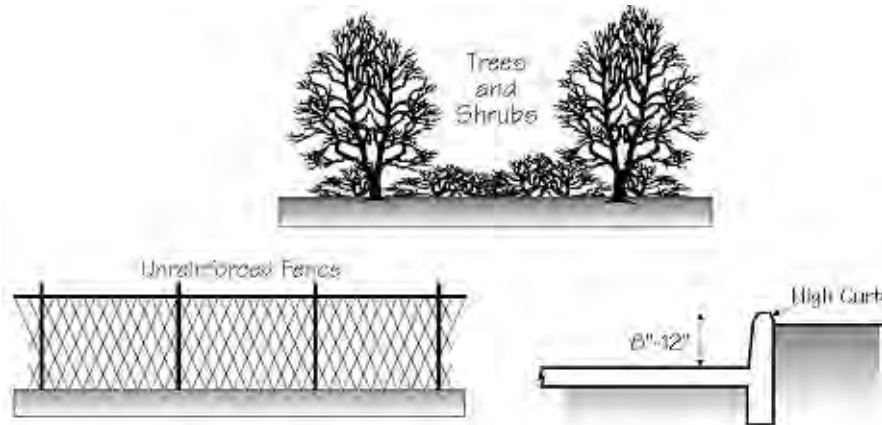

Figure 4-3. Passive Perimeter Barriers for Moving Vehicle Bombs

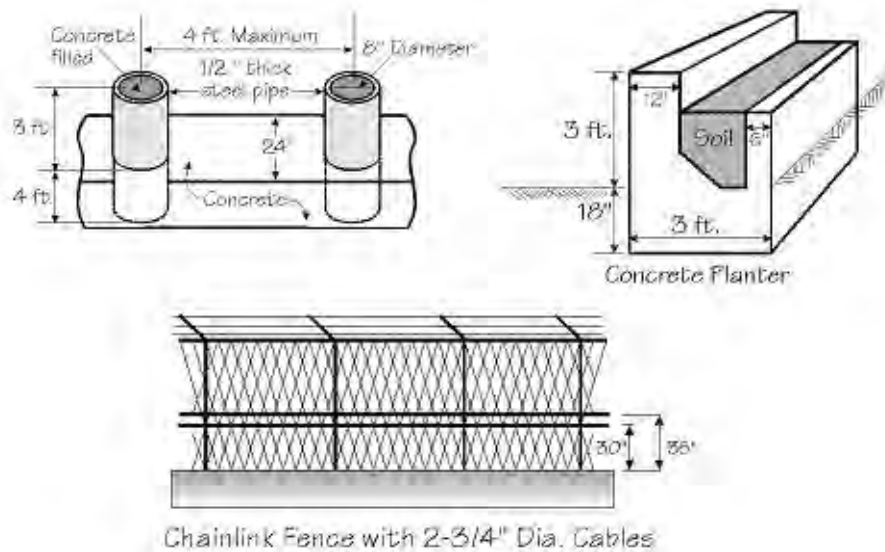

Figure 4-4. Active Vehicle Barriers for Stationary Vehicle Tactic

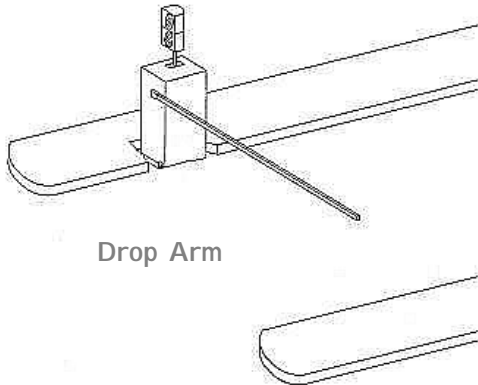
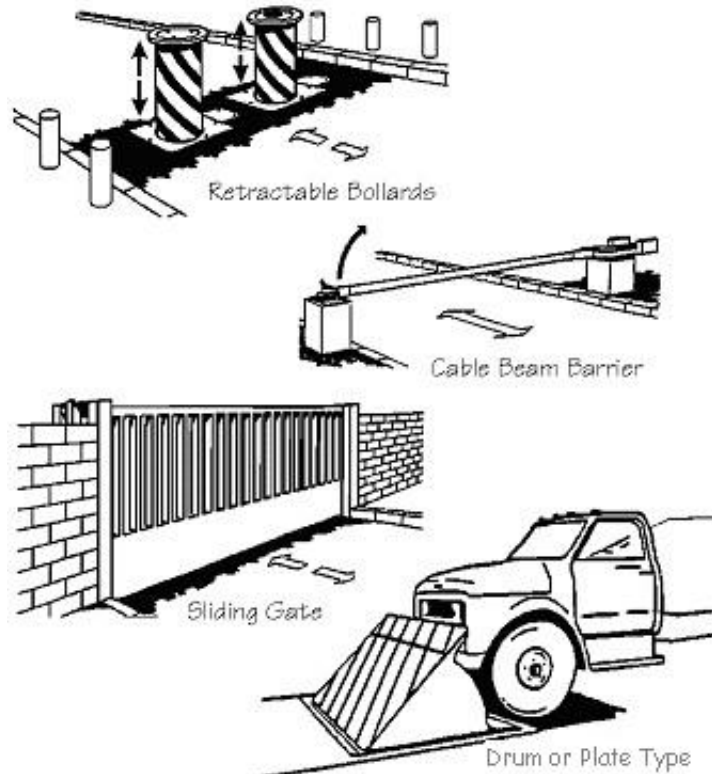

Figure 4-5. Active Vehicle Barriers for Moving Vehicle Tactic



4-2.3.2 Building Elements.

4-2.3.2.1 **New Construction.** Where standoff distances for conventional construction can be met, the impact on building construction will be limited. If the building is less than 3 stories, the only building elements that will have requirements beyond conventional construction are the doors and windows. Windows will have to be made with laminated glass and heavier frames than are common in conventional construction as required by the *DoD Minimum Antiterrorism Standards for Buildings (UFC 4-010-01)*. Glazed doors will require laminated glass as well, and unglazed doors should be hollow steel to minimize fragmentation in the event of an explosion. They should also open outward, which may have some impact on elevated walkway widths. Finally, to minimize hazards from doors flying onto rooms, they should be backed up with walls that could intercept them as illustrated in Figure 4-6. For inhabited buildings that have three or more stories, the progressive collapse provisions of UFC 4-010-01 will have to be incorporated into the design.

Figure 4-6. Entry Foyer to Reduce Door Hazards

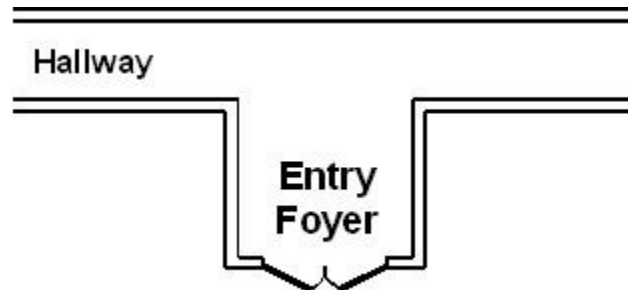

Where conventional construction standoff distances are not available, most of the major components of buildings are likely to be impacted. Walls and roofs may be thicker and heavier, windows may be heavier and constructed out of more expensive materials, and doors may be of heavy steel construction. In addition, building frames and other superstructure elements may also have to be heavier. The cost increases associated with those modifications to conventional construction are reflected in the cost appendices in this UFC.

4-2.3.2.2 Existing Buildings. Where conventional construction standoff distances can be met, the only impact on the existing construction is likely to be in windows and doors. The same considerations apply for windows and doors as described in the previous paragraph, but in the case of existing buildings, the existing windows and doors will probably have to be removed and replaced with the windows and doors described above. Where an existing building is not required to meet the requirements of the *DoD Minimum Antiterrorism Standards for Buildings (UFC 4-010-01)*, window retrofits using materials such as fragment retention film or drapes may be used. There may also be cases in which the walls around the windows and doors have to be strengthened to handle the loads associated with the new windows and doors resisting the explosives effects.

Where conventional construction standoff distances are not available, the buildings' walls and roofs may have to be retrofitted to resist the applicable blast loads. In the case of the walls, there are retrofits that can be applied to the inner faces of the existing walls. In the case of roofs, removing the existing roof and replacing it with a new roof is the most economical way to provide the required protection.

4-2.3.3 Equipment. Equipment such as electronic entry control devices like card readers may be incorporated into protective systems to reduce requirements for permanent manpower. Those systems may also be augmented with closed circuit television systems or such systems may be employed in support of access control with equipment such as intercoms instead of electronic entry control systems. In general,

these kinds of equipment will be installed in support of access control at entry control points through perimeters.

4-2.3.4. **Manpower and Procedures.** As stated above in the context of the design strategy for these tactics, manpower and procedures are a critical element of protective systems for these tactics. Their impacts on project scope mostly relate to the potential for increased equipment requirements where there are inadequate manpower resources available. Procedures may also increase requirements because they may increase the time required to allow vehicles through entry control points, which may lead to needing either more lanes at the entry control points or additional entry points. Manpower considerations may also drive the need for shelters for guards and other such appurtenances that may add to sitework costs.

4-2.3.5 **Expeditionary and Temporary Construction Considerations.** Most of the protective measures that will be applied in the expeditionary environment are sitework measures. Because it is generally impractical to harden or retrofit expeditionary and temporary construction significantly, increased standoff distance is the primary approach to providing protection in that environment. That will commonly drive the need for larger sites. In addition, barrier construction will generally include more temporary or improvised barriers than would commonly be provided for permanent construction.

4-3 **HAND DELIVERED DEVICES.** Because this tactic includes delivery of explosives and incendiary devices either to the exterior of buildings or attempts to deliver them into buildings, the design strategies will be discussed in the context of the exteriors of facilities and building entry points, mail rooms, and supplies handling areas.

4-3.1 **General Design Strategy.** The general design strategy for this tactic, regardless of the location of the explosive or incendiary device, is to attempt to detect the device and to ensure that assets inside buildings are protected in accordance with the applicable level of protection in the event a device detonates. For devices assumed to be placed exterior to a building, that generally requires an unobstructed space within which placed explosives or incendiary devices can be visually detected and building elements that are designed to resist the explosive effects of a detonation outside the distance associated with that unobstructed space. For devices at entry and delivery points into buildings, the general design strategy includes providing for detection of the device at those points and designing those areas to minimize damage to assets inside the building from a detonation inside those entry or delivery points.

4-3.2 **Specific Design Strategies.** Specific design strategies generally follow the same goals for protection of assets as the vehicle bomb tactic, but with additional emphasis on detection.

4.3.2.1 **Sitework Elements.** Sitework elements are only an issue for this tactic in the context of explosives or incendiary devices being placed at the exteriors of buildings. The only variance among levels of protection is that the high level of

protection requires perimeter barriers to control access to the unobstructed spaces around the buildings and to reduce vulnerabilities associated with thrown devices.

4-3.2.2 **Building Elements.** The design goals associated with the different levels of protection are summarized in Tables 4-2 and 4-3. For exterior explosions those design goals are focused on the exterior building elements. For explosions at entry points, mail rooms, and supplies handling areas, those goals are focused on the building elements directly associated with the entry point areas and with the building elements in the immediate vicinity of those areas elsewhere in the buildings.

4-3.2.3 **Detection.** Detection is a critical component of the design strategy for this tactic. How detection is applied is significantly different whether the explosive or incendiary device is at the exterior of a building or at an entry point, mail room, or supplies handling area.

4-3.2.3.1 **Exterior Attacks.** For exterior attack considerations, detection at the low and medium levels of protection is based on visual observation of the unobstructed space. The high level of protection adds the requirement for perimeter detection outside the unobstructed space using some form of exterior intrusion detection system or guards.

4-3.2.3.2 **Attacks at Entry and Delivery Points.** At entry and delivery points it is necessary to detect explosives or incendiary devices either being carried into buildings or delivered to them. Detection is provided using either operational procedures or electronic equipment, depending on the level of protection. For the low level of protection, detection is provided only through operational procedures. For the medium level of protection, X-ray equipment and metal detectors are applied. The high level of protection includes the addition of explosive detectors. These measures will be applied at mail rooms and supplies handling areas as applicable for delivered devices and at either building or site entry points for devices that are being carried into buildings.

4-3.3 **Project Scope Implications.**

4-3.3.1 **Sitework Elements.** Sitework elements are only a consideration for explosive or incendiary devices being placed outside buildings or thrown at them. At the low and medium levels of protection, sitework considerations are limited to establishing unobstructed spaces as required in the *DoD Minimum Antiterrorism standards for Buildings (UFC 4-010-01.)* The extent of that unobstructed space can vary with threat severity level (explosive weight) and level of protection.

4-3.3.1.1 **Low and Medium Threat Severity Levels.** The 10 meter (33 feet) unobstructed space required by the minimum standards will generally be adequate for the low and medium threat severity levels at all levels of protection. The assumption in that is that explosives placed in that unobstructed space will be seen by passers by and that they are relatively small, so their detonation would result in minimal damage to people inside the buildings anyway.

4-3.3.1.2 **High Threat Severity Level.** For the high threat severity level at the low and medium levels of protection, the unobstructed space may need to be extended farther from the building. The reason for that goes back to the assumption that explosives placed in the unobstructed space will be visually detected; therefore, it is further assumed that the explosive will generally not be placed in that space. The unobstructed space may need to be extended because the standoff distance it provides will have to be based on the larger explosive associated with the high threat severity level. That standoff distance will be based on both available land and building construction. Where there is adequate standoff distance, conventional construction may be adequate to provide the required level of protection. Where there is insufficient standoff, building hardening may be necessary. The cost tables in Appendices A and B account for building hardening where appropriate.

4-3.3.1.3 **High Level of Protection.** For the high level of protection for all threat severity levels, there are additional sitework requirements to the unobstructed space. That level of protection requires establishment of an exclusive standoff zone to ensure aggressors cannot get close enough to the building to place an explosive. That exclusive standoff zone is located at whatever standoff distance is necessary to provide the required level of protection against the threat explosive based on the building construction. That standoff zone should be fenced to provide an effective barrier to access. In addition, to minimize vulnerabilities associated with thrown explosives, trees may be placed around that perimeter to assist in intercepting those thrown explosives. The unobstructed space, therefore, is not as significant a consideration, but the minimum unobstructed space should be retained in accordance with the *DoD Minimum Antiterrorism standards for Buildings (UFC 4-010-01.)* Figure 4-7 illustrates a site design that would meet the requirements for the high level of protection.

Figure 4-7. Site design example for high level of protection

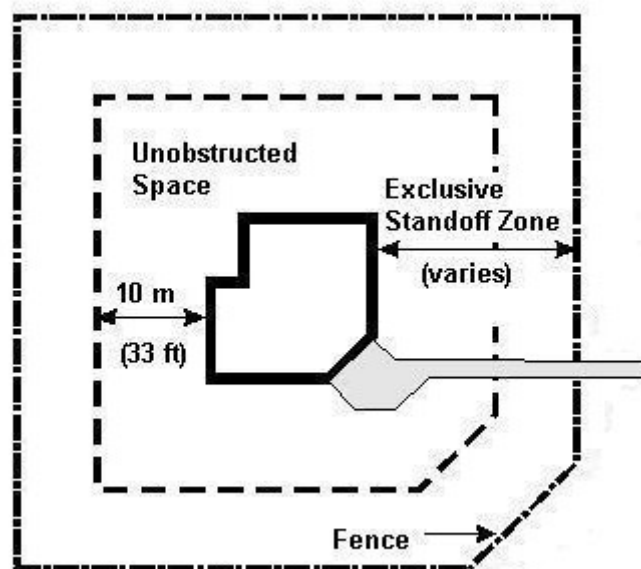

4-3.3.2 **Building Elements.** Building elements have the most significant implications for project scope for this tactic. The implications are for the exterior of the building as well as at and in the vicinities of entry and delivery points. Variances among levels of protection are limited to how much damage will be allowed in response to an explosion as reflected in Tables 4-2 and 4-3.

4-3.3.2.1 **New Construction.**

4-3.3.2.1.1 **Building Exterior.** The building exterior should be designed to provide the applicable level of protection to the bulk explosive at the edge of either the unobstructed space or the exclusive standoff zone. It should also be designed for smaller thrown explosives and incendiary devices well within those standoff distances.

For the low threat severity level, the only exterior requirements are that the building exterior be fire resistant, which is consistent with common building practice, and that windows be resistant to thrown objects. The DoD minimum window required by UFC 4-010-01 is generally adequate for that. For the medium threat severity level, the building exterior must further provide resistance to the small explosive and fragments associated with the explosives at that threat severity level. Because of the small size of the explosives, significant hardening is only considered at the high level of protection.

For the high threat severity level, where the unobstructed space or exclusive standoff zones are set at a standoff distance in accordance with Table 4-1, the only building elements for which there are any implications above those of conventional construction are doors and windows, which will have to meet the minimum standards in UFC 4-010-01. Where those conventional construction standoff distances cannot be provided, the implications for the exterior building elements will commonly be thicker and more heavily reinforced walls, blast resistant windows, heavier doors, and thicker and more heavily reinforced roofs. Those enhanced building elements will need to be applied over the entire building perimeter except in areas that are not inhabited.

4-3.3.2.1.2 **Entry and Delivery Points.** Because the general design strategy for this tactic assumes that no explosives or incendiary devices will be allowed into buildings, the entry and delivery points must be built such that there are opportunities to detect those devices and designed such that damage in the event of an explosion will be minimized outside the immediate vicinity of the entry or delivery points. One implication of implementing that assumption is that the entry and delivery points may have to be larger to accommodate detection equipment and search areas. The other implications are that the entry and delivery point areas will have hardened construction consisting of heavily reinforced interior walls and ceilings and blast resistant doors between those areas and the rest of the building. At least one exterior wall for the entry and delivery points will be designed to fail in response to an explosion so they can vent the explosive effects. The latter issue may result in additional requirements for the exterior of the building in the vicinities of the entry and delivery points as well. If possible, configurations of mail rooms and delivery areas should avoid doors directly into the buildings. Figure 4-8 illustrates these principles.

Figure 4-8. Entry and Delivery Points

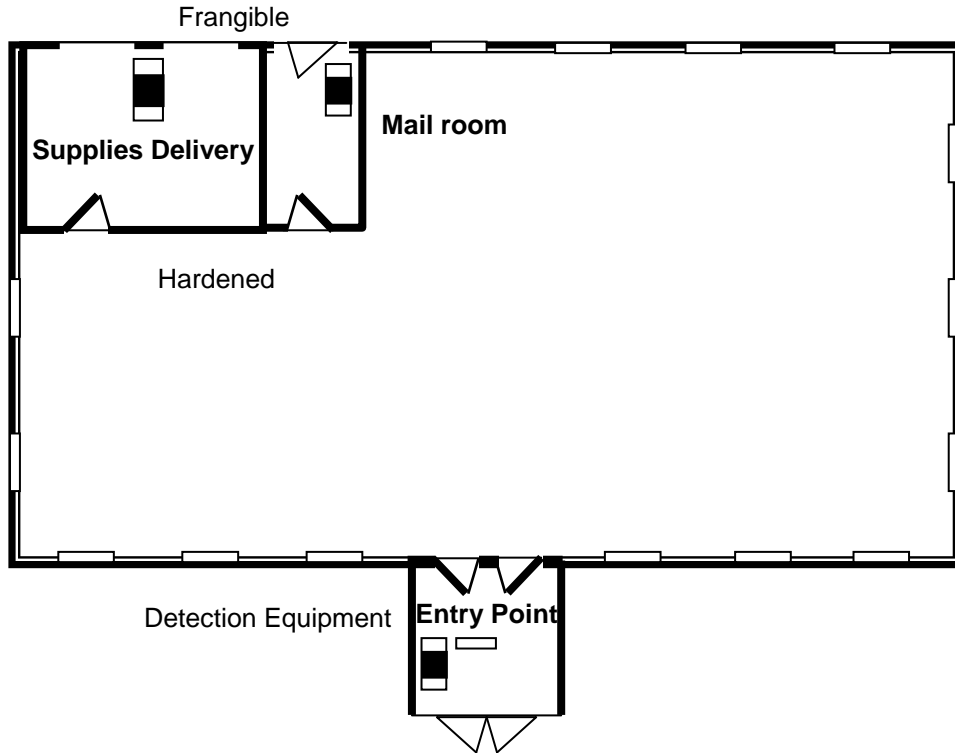

4-3.3.2.2 **Existing Buildings.** Building retrofit considerations are similar to those for new construction, but they may involve modifying the existing construction. For the exterior of the building, there should be no issues other than the replacement of the windows as described above for the low threat severity level. Similarly, there should be minimal impacts for the medium threat severity level except for at the high level of protection.

For the high level of protection at the medium threat severity level and for all levels of protection at the high threat severity level, the building exterior may have to be retrofitted, including replacing windows and doors and adding wall retrofits to the interior of the buildings' exterior walls. Regarding roofs, in most cases the existing roofs will have to be removed and replaced with new ones.

For entry and delivery points, because of their limited size, the most economical solution is to remove the existing building components and replace them with construction similar to that for new construction.

4-3.3.3 **Equipment.** Equipment has minimal project implications for this tactic, except at the medium level of protection and higher. The equipment will generally include access control, metal detection, X-ray screening, or explosive detection equipment installed at the entry and delivery points. That equipment will commonly not be able to be provided as part of the Military Construction funding because it will not be installed equipment that is affixed to or built into the facility. Such equipment will

commonly have to be funded through other appropriations in accordance with DoD component guidance. At the high level of protection, an additional equipment implication is the installation of perimeter intrusion detection systems at the exclusive standoff zone. That intrusion detection equipment may or may not be augmented with closed circuit television equipment for assessing intrusion alarms depending on user preference and operational considerations. The intrusion detection equipment also commonly will not be able to be funded as part of Military Construction.

4-3.3.4 **Manpower and Procedures.** Manpower and procedures implications on construction are limited, but they need to be incorporated into the overall project planning and operation. For the design strategy for this tactic to be effective, there need to be trained people capable of detecting explosives and incendiary devices available. For those devices placed outside of buildings, that detection may be provided through increased occupant awareness and procedures for what to do in the event that an explosive or incendiary device is observed outside the building. For detection of devices at entry and delivery points there need to be trained people dedicated to detecting those devices either through operational procedures or through the operation of detection equipment. In either case, there also need to be qualified people who will respond to detection of an explosive or incendiary device, such as an explosive ordnance disposal team.

4-3.3.5 **Expeditionary and Temporary Construction.** Generally, considerations such as hardening building elements are not realistic for expeditionary and temporary construction.

4-4 **INDIRECT FIRE WEAPONS.** Because this tactic involves weapons fired from a distance and over any practical obstacles that could be erected to block them, the design strategies for this tactic are all based on hardening of buildings to resist the effects of the weapons impacting on or near buildings.

4-4.1 **General Design Strategy.** The general design strategy for this tactic is to design a targeted building to protect assets inside it from the detonation of the threat weapon at locations that vary by level of protection. That design will generally require building hardening, which will vary with threat severity because the weapons range from simple incendiary devices to large improvised high explosive warheads.

4-4.2 **Specific Design Strategies.** Specific design strategies vary based on the distance from the impact of the threat weapon to the target building, the response of the building elements to the detonation of the weapon, and the fragment penetration through the building elements.

4-4.2.1 **Impact Distance.** Because the low level of protection commonly involves acceptance of significant risk, the impact distance for that level of protection is assumed to be a "near miss" at 5 meters (approximately 16 feet). Note that 5 meters is half of the recommended separation distance between buildings in the *DoD Minimum Antiterrorism Standards for Buildings (UFC 4-010-01)*, which suggests that in the case of adjacent

buildings, the impact point will be midway between the buildings where that recommendation is followed. The impact distance for the medium level of protection is a near miss of 2 meters (approximately 6 feet). The impact distance for the high level of protection is based on a “near contact” condition equal to the warhead diameter of the weapon. Impact distance is only an issue for walls, doors, and windows. Because it is as likely that a round would land on a roof as it is to land nearby, the roofs are designed for direct impact.

4-4.2.2 Building Element Response. Building element responses will vary significantly with the kind of building element (wall, roof, window, door) and the materials used. In general, building element response will be evaluated based on the overall member response and on the degree of “breach.” The overall building element response is governed by Tables 4-2 and 4-3.

Breach refers to the degree to which the building materials are locally damaged and their resulting dispersal into the protected building. Breach is where the material fails and there is a hole through the wall, roof, or other element. The material from that element may disperse into the protected building, potentially injuring people or damaging other assets. Spalling is a phenomenon exhibited by many materials wherein the building element is not breached in response to an explosion effect or an impact, but a portion of the interior face of the element “pops off” and disperses into the building. Spall is commonly less dangerous than breaching. Spall and breach are governed by the criteria below:

- Low level of protection: Onset of breach (spall)
- Medium level of protection: Medium spall (no breach)
- High level of protection: Onset of spall

Application of building element response and spall or breach is covered in more detail in the *DoD Security Engineering Facilities Design Manual (UFC 4-020-02.)*

4-4.2.3 Fragment Penetration. Most indirect fire weapons involve what are referred to as primary fragments, which are pieces of the casing for the explosive that are propelled at high velocity in response to the detonation of the warhead. Those primary fragments result in a specific loading on building elements, and they also may penetrate them. The following summarizes the criteria for considering fragment penetration (where applicable):

- Low level of protection: Perforation by 10 fragments
- Medium level of protection: Perforation by 3 fragments
- High level of protection: Perforation by 1/2 fragment

4-4.3 **Project Scope Implications.**

4-4.3.1 **Sitework Elements.** Because indirect fire weapons fire over obstacles, there are no practical sitework elements that can be applied to mitigate this tactic. The only sitework issue would be building separation to minimize the possibility of causing damage to multiple facilities from one weapon.

4-4.3.2. **Building Elements.** Effectively, all of the impacts on project scope will be in building elements, which will be affected by whatever hardening is applied to meet the applicable level of protection.

4-4.3.2.1 **New Construction.** For the low threat severity level (incendiary devices) the only implications to building element design are in flame resistance and the ability to keep the incoming warhead from penetrating the building and igniting inside. For the higher threat severity levels, however, the building elements will have to resist the effects of exploding warheads. Those effects will result in thicker walls, which will most commonly be constructed of reinforced masonry or concrete. They could also be built or retrofitted with steel plate, but that is generally more expensive.

4-4.3.2.1.1 **Windows.** Windows that are designed to resist the resulting explosive and fragment effects will generally need to be quite thick and would require the use of special materials such as polycarbonate. Because of that, the recommended solution is to use narrow, elevated windows that do not resist fragments, but only allow fragments to pass over the heads of building occupants. Where windows need to be able to be used for emergency egress, narrow, vertical windows can be used instead. In those cases, room layout would have to be adjusted to minimize exposure to occupants behind those windows. Those windows are illustrated in Figure 4-9. In either of the previous cases, the windows will still need to be designed to resist the blast load to the appropriate level of protection to minimize exposure of occupants to hazardous window fragments. Windows are not practical for the high level of protection.

4-4.3.2.1.2 **Doors.** Doors designed to resist the explosive and fragment effects would require the use of heavy steel plates. Such doors would be very heavy and expensive. For those reasons, the approach taken in this UFC is to build a foyer outside the building's doors and allow the foyer to take the explosive and fragmentation effects of an exploding round, the foyers need to have walls constructed the same as the building's walls. Doors into the foyers need to be offset from the doors into the building. The roofs of the foyers need to be designed the same as for the rest of the building to ensure incoming rounds do not penetrate them and explode within the foyer. Figure 4-10 shows foyers on the outside of a building.

Figure 4-9. Narrow Windows

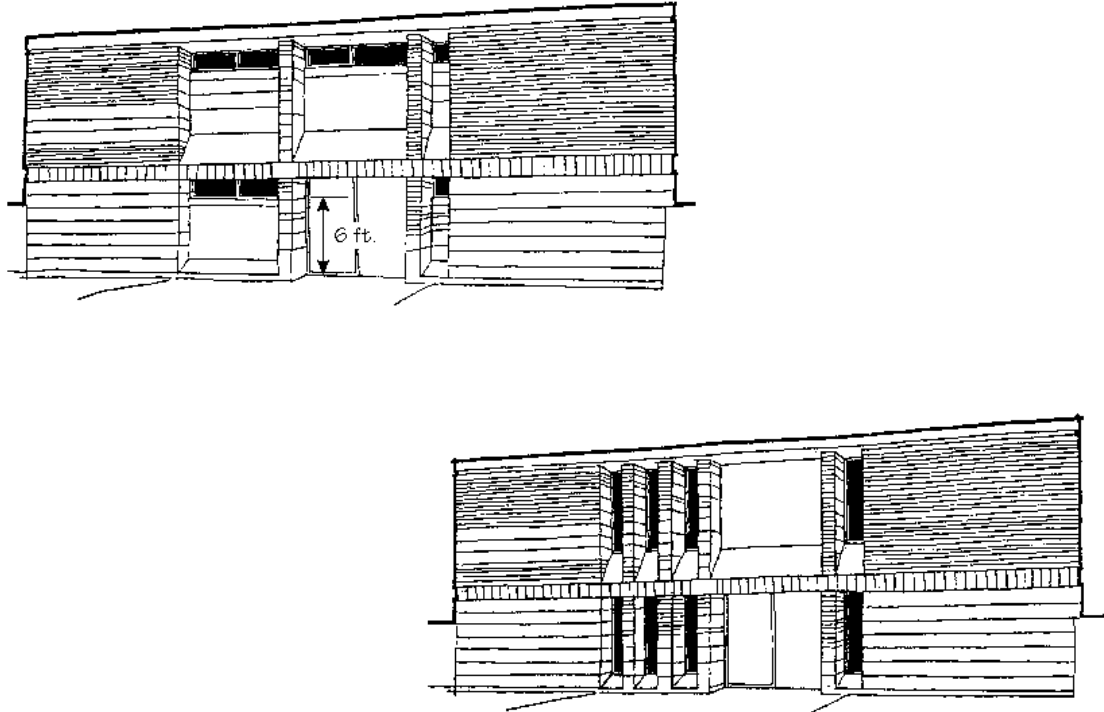

4-4.3.2.1.3 **Roofs.** Roofs designed to resist the direct impact of an incoming round will generally require thick heavily reinforced concrete. A more economical approach to the problem is to construct a sacrificial roof above the building's primary roof and to construct the primary roof to resist the effects of the round exploding at that standoff distance. That is the approach taken in developing the costs in Appendices A and B. The building's walls have to be extended to hold up the sacrificial roof and ensure rounds don't enter underneath it.

The sacrificial roof can be of conventional construction, although some lightweight roofs may need to be hardened slightly using such construction as rigid insulation and steel deck underneath to ensure incoming rounds detonate on the roof instead of beneath it. The insulation is used because some common mortar and rocket rounds have fuses that are inset from the nose of the round. Such rounds may not detonate on some solid conventionally constructed roofs, but they detonate as they pass through the rigid insulation because the insulation pushes into the recess in the nose cone. The hardened roof beneath the sacrificial roof will be reinforced concrete. For the purposes of developing costs in Appendices A and B, the standoff distances to the sacrificial roofs are at 2 meters (6 feet) and 4 meters (12 feet), representing half story and full story height, respectively. The space between the sacrificial roof and the

hardened roof should not be occupied. Figure 4-10 shows sacrificial roofs on the building and on foyers.

Figure 4-10. Sacrificial Roof and Exterior Foyers

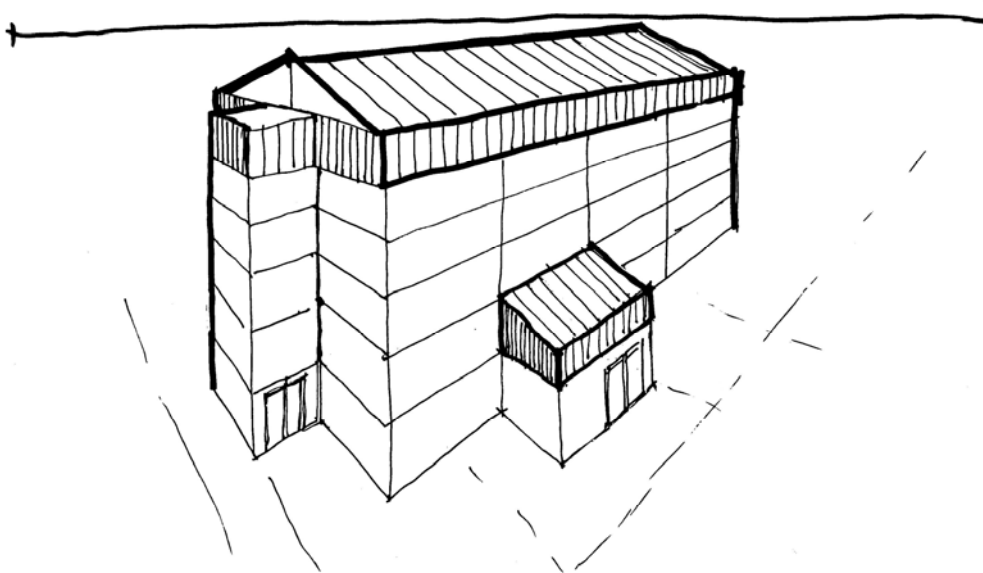

4-4.3.2.2 Existing Buildings. At the low threat severity level, which only requires fire resistant construction sufficient to keep the incendiary device from penetrating the building shell, retrofits should be minimal. At the higher threat severity levels, however, retrofitting existing buildings to resist the indirect fire weapons effects may be impractical in most cases. Walls require retrofits that resist the blast effects based on the explosive weight in the round, and they must provide sufficient thickness of concrete, masonry, or steel to resist the weapons' fragments. Such retrofits are only practical for the low and medium levels of protection for the medium and high threat severity levels. There are no practical retrofits for the very high threat severity level. Windows have to be replaced and the surrounding walls modified to create narrow window configurations such as those shown in Figure 4-9. In those cases, room layout has to be adjusted to minimize exposure to occupants behind those windows. Doors have to be replaced to provide door configurations similar to those described for new construction. Roofs would have to be removed and replaced with roofs similar to those described for new construction, including sacrificial roofs.

4-4.3.3 Equipment. The application of equipment to detect incoming indirect fire is impractical, so there are no equipment implications to project scope.

4-4.3.4 Manpower and Procedures. Because of the nature of the indirect fire weapon threat, there are no effective procedures that can be directly associated with an individual building to mitigate the attacks other than in response after an attack. At that point there should be emergency response procedures (fire and rescue) and building

occupants should know to duck under whatever furniture they can.

4-4.3.5 Expeditionary and Temporary Construction. In general, hardening expeditionary and temporary construction to mitigate indirect fire weapons attack is impractical. The solutions, therefore, are commonly in dispersal of facilities so that one weapon does not damage multiple facilities and in construction of collective bunkers to which people can evacuate in anticipation of additional attacks. In addition, barriers such as wire mesh bastions or shielding walls can be erected to shield structures from fragments and to mitigate propagation of weapons effects to adjacent structures. These approaches are illustrated in Figure 4-11 below, which shows a cluster of SEA huts surrounded by wire mesh bastions.

Figure 4-11. Shielded SEA Hut Cluster

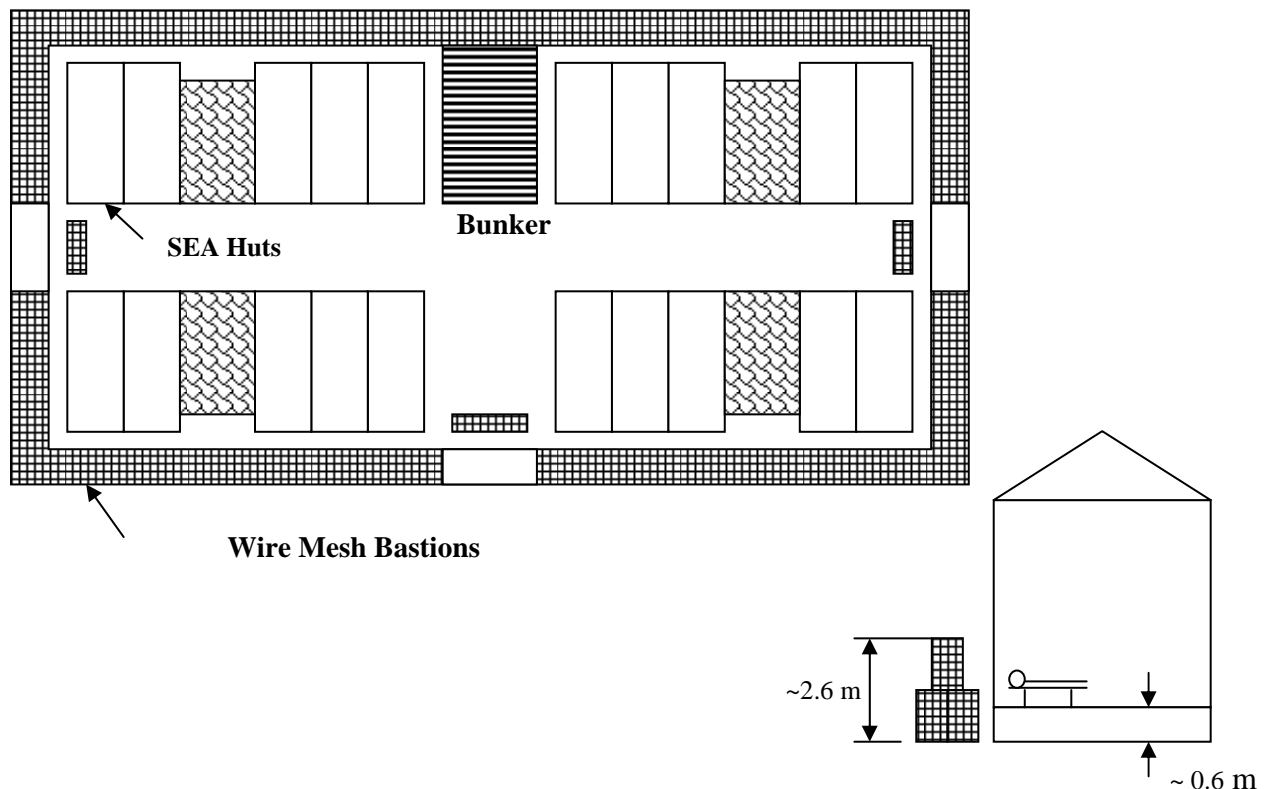

4-5 DIRECT FIRE WEAPONS. Because there are generally no opportunities to detect and prevent direct fire weapons attacks, the design strategies for this tactic are based on shielding and hardening.

4-5.1 General Design Strategy. The general design strategy involves identifying vantage points from which direct fire weapons can be launched and, depending on the level of protection, either blocking sightlines to assets and building occupants or hardening the building elements to resist the direct fire weapons effects.

4-5.2 Specific Design Strategies. Because this tactic includes both small arms and antitank weapons, and because the effects of those weapons vary

significantly, the specific design strategies will not apply equally to all threat severity levels. Specifically, the medium level of protection only applies to the high threat severity level, which includes antitank weapons and high caliber small arms (12.7 mm or .50 caliber). For the threat severity levels that are limited to small arms of less than 12.7 mm (.50 caliber), apply the low level of protection design strategy for the medium level of protection.

4-5.2.1 **Low Level of Protection.** For all threat severity levels (involving both small arms and antitank weapons), the design strategy for this level of protection is to block sightlines to building occupants or assets. The assumption in that is that aggressors will not shoot at what they cannot see. Blocking sightlines may include applying both building and sitework elements.

4-5.2.2 **Medium Level of Protection.** The medium level of protection may apply to all threat severity levels, but is only practical in the case of large caliber small arms (like the 12.7 mm or .50 caliber) and antitank weapons. It includes the installation of predetonation screens that detonate antitank rounds at a specific distance from a target, and allow the effects of the antitank rounds to dissipate prior to impacting a building. The combination of that standoff distance and building element construction will prevent the small arms and antitank rounds from breaching the building envelope. An energy absorption screen can be installed in the case of large caliber small arms to reduce the energy of the small arms rounds before they impact the building.

4-5.2.3 **High Level of Protection.** For all threat severity levels (involving both small arms and antitank weapons), the design strategy for this level of protection is to harden building elements such that they resist the direct effects of the threat weapon.

4-5.3 **Project Scope Implications.**

4-5.3.1 **Sitework Elements.** Sitework elements only apply at the low and medium levels of protection. At the low level of protection, various landscaping elements or opaque barriers can be applied to block sightlines to occupied portions of buildings. The medium level of protection includes an energy absorption screen or a predetonation screen. The predetonation screen can be a solid fence or wall that will be sufficient to detonate an antitank round on impact. Commonly, that requires a surface of concrete, concrete masonry, steel, or at least 20-millimeter (approximately $\frac{3}{4}$ inch) thick wood. The predetonation screen should be placed to shield the occupied portions of buildings and will have to be between 3 and 12 meters (approximately 10 and 40 feet) away from the building depending on building construction. To serve as both a predetonation and energy absorption screen requires reinforced concrete or masonry because it requires much more mass to reduce the energy of a large caliber bullet than to predetonate an antitank round.

4-5.3.2 **Building Elements.** Implications to building elements are dependent on the level of protection.

4-5.3.2.1 **New Construction.**

4-5.3.2.1.1 **Low Level of Protection.** Because the design strategy for the low level of protection for all threat severity levels is concealment, there are limited implications to building elements. Since walls and roofs are generally opaque, there are no considerations for them. The only considerations, therefore, are for openings such as windows, skylights, and doors. The implications to windows and doors are either to configure them so that occupants and other assets are not visible through them or to provide treatments such as reflective coatings, shades, or drapes that make them difficult to see through. Skylights would have similar implications, but only if there were vantage points nearby from which those could be targeted.

4-5.3.2.1.2 **Medium and High Levels of Protection.** At the medium and high levels of protection the exterior building elements will have to resist the weapons effects for the threat weapons. For the small arms threats the implication to that is the use of bullet resisting construction. Generally, reinforced masonry or concrete walls will provide such resistance with 200-millimeter (8-inch) thick reinforced masonry or 150-millimeter (7-inch) reinforced concrete providing resistance up to the 7.62-millimeter rounds. For the higher caliber bullets and antitank rounds in the high threat severity level, the walls are likely to be thicker.

Doors and windows are commercially available to resist the small arms threats of 7.62 millimeters and smaller, but those assemblies will be thicker and heavier than conventional windows and doors. Windows and doors are also available that can stop higher caliber bullets, but they are not as commonly available. Windows and doors that would resist either predetonated antitank rounds or direct hits from those rounds are not practical. The implications for that are that those windows and doors will have to be shielded, configured to preclude lines of sight to occupants or assets, or eliminated.

Roofs and skylights are only an issue where there are sightlines to them from nearby vantage points. Where there are such sightlines, roofs and skylights will have to be treated similarly to walls and windows.

4-5.3.2.2 **Existing Buildings.** Retrofit considerations for the low level of protection are similar those for new construction. Windows and doors would need to have means to limit vision through them as described above. For the medium and high levels of protection, windows and doors will have to be replaced with bullet resistant window and door assemblies. Walls may have to have additional thickness of concrete or masonry added or steel plate added to the backs of the walls.

4-5.3.3 **Equipment.** Because of the fact that these attacks are commonly launched from a distance without warning, there is no practical opportunity to apply equipment to mitigate vulnerabilities to this tactic.

4-5.3.4 **Manpower and Procedures.** As with equipment, there are no practical applications of manpower and procedures in mitigating these attacks other than ensuring that people know to take cover immediately after detecting an incoming round and in some environments, firing back at the aggressors.

4-5.3.5 **Expeditionary and Temporary Construction.** It is generally not difficult to provide the low level of protection for expeditionary and temporary construction, but it is generally not practical to provide higher levels of protection through hardening of the structures themselves. The approach, therefore, is to provide shielding such as that illustrated in Figure 4-11.

4-6 **AIRBORNE CONTAMINATION TACTIC.** One of the critical assumptions inherent in the design strategies for this tactic is that airborne contaminants will be delivered into buildings from either outside the building or at entry or delivery points. Contaminants cannot be allowed to enter into buildings further than those points.

4-6.1 **General Design Strategy.** Based on the above assumption, the general design strategy for this tactic is to provide access control and screening to ensure that agents are not introduced into buildings and to design the building elements and building support systems to ensure that agents introduced from outside the buildings or at entry and delivery points are kept out of the buildings. This is commonly referred to as collective protection.

That generally means that building envelopes will be designed to minimize air infiltration and exfiltration and that at other than the very low level of protection the buildings will be pressurized to keep airborne agents out. That pressurization requires filtration to retain the purity of the makeup air necessary to retain overpressurization. In addition, ventilation systems for entry and delivery points will be isolated from the remainder of the buildings.

Note that the design strategy does not include detection of agents. Theoretically, automatic detectors can be used to initiate protective actions such as shutdown of ventilation systems, closing outside air intakes, or turning on filtration systems. Detection of radiological agents can be performed quickly with off-the-shelf equipment; however, current biological detection technology requires a minimum delay of approximately 15 minutes to detect the presence of biological agents, although there is high-end research and development equipment capable of detecting within a few minutes. Practical application of chemical detection is limited by shortcomings in response time, false alarms, broad-spectrum capability, maintenance requirements, cost, and the quantity of sensors needed for the various chemical agents at air intake locations. Therefore, the design strategy will be dependent on intelligence or operational detection of events rather than automated detection.

4-6.2 **Specific Design Strategies.** The specific design strategies associated with the levels of protection vary in the type of filtration provided, the air that is filtered, and the continuity of operation. The application of higher levels of protection includes the applications of all measures in lower levels of protection. Collective protection is also described by overpressurization class, which refers to the duration that the asset must be protected against the threat based on emergency operational procedures and the overpressurization that must be provided to resist particular wind speeds within the collective protection area.

4-6.2.1 **Very Low Level of Protection.** The strategy at this level of protection can be referred to as sheltering in place. It includes application of passive building element features to minimize air infiltration and the means to shut down the ventilation systems to limit dispersal of any agents that might infiltrate the building envelope.

4-6.2.2 **Low Level of Protection.** The strategy at this level of protection adds to that of the previous level of protection the application of high efficiency particulate air (HEPA) filters at air intakes. As a practical matter, however, the HEPA filters are generally installed in the central air-handling unit and they filter both the outside and recirculated air. A slight positive overpressurization of the building, referred to as Class II overpressure, should be added. The HEPA filtration should be run continuously and will remove biological and radiological agents.

4-6.2.3 **Medium Level of Protection.** The strategy at this level of protection also includes HEPA filtration and adds vapor adsorber systems with carbon filters to the outside air intakes to filter out chemical agents. It also provides either Class II or Class I overpressurization depending on operational considerations (see UFC 4-020-02). The filter system should be run continuously or in response to a threat or a heightened force protection condition.

4-6.2.4 **High Level of Protection.** The strategy at this level of protection includes HEPA filtration and vapor adsorber systems with carbon filters for both outside and recirculated air. It also includes Class II or Class I overpressurization, depending on operational considerations (see UFC 4-020-02). The filter system should be run continuously.

4-6.3 **Project Scope Implications.** The project scope implications for this tactic include building support systems, which were not included for the previous tactics.

4-6.3.1 **Sitework Elements.** Because the focus of this tactic is on keeping agents out of buildings, there are very limited sitework element implications. The only issues are in maintaining unobstructed space around buildings and avoiding locating buildings in depressions where air could stagnate.

4-6.3.2 **Building Elements.** The only implications to building element design are in designing building elements to minimize air infiltration and exfiltration. Modern energy efficiency design considerations go a long way toward achieving this design goal. In addition, windows should be inoperable and access to mechanical rooms and exterior ventilation system components should be secured. The considerations are the same for new construction and for existing buildings.

4-6.3.3 **Building Support Systems.** The most significant implications to project scope are in the heating, ventilating, and air conditioning (HVAC) systems. Fresh air intakes will need to be elevated to at least 3 meters (10 feet) as required by the *DoD Minimum Antiterrorism Standards for Buildings (UFC 4-010-01)*. In addition, UFC 4-010-01 requires that the ventilation system be capable of being shut off from multiple

locations throughout buildings in response to a threat. Other implications to the HVAC systems include isolating entry and delivery points from the remainder of the protected buildings and providing the filtration systems required to meet the applicable levels of protection. Those filtration systems as well as the overpressurization requirements may necessitate larger air handling units and will necessitate larger mechanical rooms. The considerations are the same for new construction and for existing buildings.

4-6.3.4 **Equipment.** Equipment is generally assumed for the purposes of this manual to be associated with detection and access control, both of which are applicable to the design strategies for this tactic. The equipment implications, therefore, are oriented to electronic entry control equipment and other equipment such as X-ray devices and metal detectors to support detection of contraband that might include chemical, biological, and radiological agents. This equipment would be located at entry and delivery points. At this time, equipment will not be considered to include chemical or biological agent detectors but may include radiological material detectors. The state of the art of chemical and biological agent detectors is not sufficiently advanced to incorporate such detectors into protective systems for buildings.

4-6.3.5 **Manpower and Procedures.** Manpower implications are limited to the people necessary to operate the equipment at the entry and delivery points. Procedures will have to be developed for such issues as how and when to shut down the HVAC systems in response to attacks and how to operate within the protected areas in terms of such things as opening and closing doors and entering and leaving buildings. In addition, there will be additional periodic maintenance requirements associated with the HVAC and filtration systems and with maintenance of other building elements to ensure minimal air infiltration and exfiltration.

4-6.3.6 **Expeditionary and Temporary Construction.** Generally the construction of expeditionary and temporary structures or the condition of buildings the DoD may occupy will limit opportunities for providing the kind of protection envisioned for this tactic directly into those projects. There are expedient shelters and transportable collective protection equipment that can be used, however. Those include self-contained shelters and liners that can be installed in tents or rooms, both of which include the necessary HVAC equipment to operate in a contaminated environment. Refer to UFC 4-024-01 for additional information on these systems.

4-7 **WATERBORNE CONTAMINATION TACTIC.** The assumption inherent in the design strategy for this tactic is that it takes large amounts of contaminants to contaminate a water supply. Of 38 likely chemical contaminants that could be entered into a small reservoir (on the order of 38,000 cubic meters or 10,000,000 gallons), 3 would require a tank car load, 19 would require a dump truck load, and 16 would require a station wagon load to create a dangerous concentration. To put that quantity of water into perspective, it represents the average daily consumption for a city of 100,000 people. In addition, most chemical and biological agents are removed by water treatment processes. Because of those facts, the focus of the design strategy for this tactic is on components of the treated potable water supply system. Another possible approach, which would require lesser amounts of contaminants, would be to introduce

contaminants into the system by overpressurizing the system at water discharge points such as faucets and hydrants. That approach is also dealt with by protecting elements of the water distribution system and through physical security.

4-7.1 **General Design Strategy.** The general design strategy for this tactic is to protect treated potable water supply and distribution system components from the introduction of large quantities of contaminants at likely access points and from small quantities introduction into the system closer to or inside buildings through physical security. The general design strategy also includes providing alternate drinking water sources in the event that the water gets contaminated. It involves both contamination avoidance and treatment. The locations to which this design strategy is should be applied include the following:

- Water sources
- Treatment plants
- Treated water storage
- Water distribution system
- Building water distribution system (plumbing)

4-7.2 **Specific Design Strategies.** There are three levels of protection associated with this tactic. The specific design strategies associated with those levels of protection vary with the sophistication of the security of the water supply and distribution system components and the frequency of use of alternate drinking water sources. All three levels of protection include protecting against the equivalent of a low threat severity level forced entry attack to the applicable level of protection and the application of access controls.

4-7.2.1 **Low Level of Protection.** This level of protection provides access control to treated potable water supply and distribution system components based on operational and procedural measures only and protection against forced and covert entry using elements of the low level of protection for those tactics (described later in this chapter.) It does not include the application of intrusion detection systems. There are no additional treatment or alternate source requirements for this level of protection.

4-7.2.2 **Medium Level of Protection.** This level of protection provides access control to treated potable water supply and distribution components to the equivalent of the medium level of protection for the covert entry tactic and to the equivalent of the low level of protection for the forced entry tactic (both described later in this chapter.) It also includes backflow prevention devices to be installed on treated potable water distribution elements and for the provision of a standby point of use treatment system to be applied either for an individually targeted building or a cluster of buildings.

4-7.2.3 **High Level of Protection.** This level of protection provides access control to water supply and distribution components to the equivalent of the high level of protection for the covert entry tactic and to the equivalent of the medium level of protection for the forced entry tactic (both described later in this chapter.) It also

includes backflow prevention devices as for the medium level of protection and adds the capability to detect contaminants at the targeted facility. Water treatment is handled through continuously operated point of use treatment systems, internal potable water production (as from a well) or from redundant water storage tanks.

4-7.3 **Project Scope Implications.** The project scope implications for this tactic are relatively limited with most resulting from consideration to forced or covert entry to water system components. This tactic also has protective systems for water distribution system elements and water storage that are not present for other tactics.

4-7.3.1 **Sitework Elements.** The project scope implications for sitework elements are limited to controlling access to the areas around water treatment plants. Because most such facilities are fenced for safety purposes, the additional project implications should be minimal. They would be limited to providing means to control access through gates. There should only be limited differences among the three levels of protection. Those differences will be in the sophistication of access control measures.

4-7.3.2 **Building Elements.**

4-7.3.2.1 **New Construction.** The implications to building elements are focused on access control and resistance to forced entry. The additional requirements will primarily be at buildings associated with water treatment and distribution or at locations in targeted buildings where the building water system could be accessed. The access control requirements may change building entry configurations and the forced entry resistance may change the construction of building components such as walls, doors, windows, and roofs.

4-7.3.2.2 **Existing Buildings.** For existing buildings, windows and doors may need to be replaced with forced entry resistant window and door assemblies or, in the case of windows, they may have forced entry resistant barriers added. Walls and roofs may have retrofits added to increase their forced entry resistance as described in the forced entry section below.

4-7.3.3 **Water Distribution System Elements.** Because there is a possibility of contaminants being introduced through discharge points such as faucets and hydrants through overpressurization, water distribution system components may be required to be fitted with backflow prevention devices. In addition, any other water distribution system components at which contaminants could be introduced will need to be secured against forced and covert entry. In most cases, the additional requirements will be limited to locks except as described in the paragraph on equipment below. The considerations are the same for new construction and for existing buildings.

4-7.3.4 **Water Treatment Elements.** The medium and high levels of protection potentially include the provision of point of use treatment systems. The implications to project scope include both providing and installing that equipment and making space for it.

4-7.3.5 **Water Storage.** Because the high level of protection may include drinking water storage, designers will have to determine appropriate water storage requirements. Those requirements will vary based on the climate and other factors. For example, water requirements will be higher in desert regions than in temperate regions. While estimation of water demand is beyond the scope of this UFC, an approximate quantity for planning purposes could be 8 liters per person per day (approximately 2 gallons per person per day). Those quantities could be provided based on the expected full time occupants of a building plus a percentage of that for the expected number of visitors per day. The percentage for visitors would vary based on how long visitors would be expected to stay. It might be larger for a building where visitors are likely to attend all day events as opposed to a building where visitors only stop briefly.

While overall water demand depends on other considerations such as toilet flushing, washing, industrial uses, and irrigation, for the purposes of addressing this threat, the focus should be limited to drinking water based on the assumption that most people could be evacuated from the building in response to a contamination event instead of staying there and operating. Where there is an operational need to provide water for washing, limited additional demand could increase storage quantities to 20 liters per person per day (approximately 5-1/4 gallons) or more.

The water storage requirements for the high level of protection are further complicated by the need for redundant storage. With that, one storage source can be used while the other is filled, allowing for testing immediately after filling and prior to use. The implications to project scope include both providing and installing the storage tanks with the appropriate contaminant sensors and making space for them.

4-7.3.6 **Equipment.** Project scope considerations for security equipment are limited to the medium and high levels of protection. Those levels of protection will add requirements for access control equipment and for intrusion detection equipment to detect aggressors as they attempt to access water distribution system elements and the water treatment site.

4-7.3.7 **Manpower and Procedures.**

4-7.3.7.1 **Manpower.** The implications for manpower are potentially to add guards at treatment plant entrances if they are not there already. Where the high level of protection applies, there may also be requirements for additional people to monitor intrusion detection systems if there are none monitoring such systems already or if the additional equipment associated with these requirements overwhelms existing personnel capabilities.

4-7.3.7.2 **Procedures.** Additional procedural measures will primarily be associated with access control to water distribution system elements. In addition, at times when building occupants are to be consuming water from the alternate sources provided, there will need to be procedures to inform building occupants of that requirement. There should also be procedures to shut off drinking fountains and other water sources

that could be used for drinking water. Additional procedures may be necessary to replace consumed water and monitor its quality.

4-7.3.7 **Expeditionary and Temporary Construction.** Water distribution in expeditionary environments often does not involve the level of infrastructure that is present in fixed installations. Often drinking water requirements are met completely with bottled water. Where there is a distribution infrastructure, however, much of the guidance above may apply to water distribution in expeditionary environments, but it will have to be tailored to the specific situation. In general, the same strategies of securing water sources and distribution and potentially providing alternate drinking water sources apply.

4-8 **WATERFRONT ATTACK.** For the purposes of this UFC, waterfront attacks are considered to come from the water. Landside attacks are covered by the other tactics in this UFC. Because this tactic involves attacks from the water, the design strategies will be based on detection and delay of and response to intruding watercraft. Requirements relating to waterfront security will also be significantly affected by Force Protection Conditions.

4-8.1 **General Design Strategy.** The general design strategy for the waterfront attack is to lay out and maintain defense in depth through the application of barriers, electronic security systems, and operational procedures. The defense in depth involves the following “zones.”

4-8.1.1 **Assessment Zone.** The Assessment Zone is an area well beyond the government’s property line. Vessels approaching the waterfront can be detected and patrol craft can be vectored to intercept them.

4-8.1.2 **Warning Zone.** The Warning Zone is an area just outside the government’s property line. It is delineated by floating signage, signs on pilings, or other lines of demarcation at the property line. Watercraft in the warning area are often paralleled by patrol craft.

4-8.1.3 **Threat Zone.** The Threat Zone is the waterside area between the government’s property boundary and the floating barrier. The inner boundary of the Threat Zone is marked with floating barriers.

4-8.1.4 **Engagement Zone.** The Engagement Zone is the area between a line of floating barriers and an asset. Watercraft entering this area are engaged and stopped using active defense measures.

4-8.2 **Specific Design Strategies.** Specific design strategies for this tactic involve increasing application of countermeasures.

4-8.2.1 **Low Level of Protection.** At the low level of protection, there are no special requirements on waterways, but restricted areas will be established with buoys and signs.

4-8.2.2 **Medium Level of Protection.** At the medium level of protection, a security zone will be established around the asset. Where possible that should be coordinated with the Coast Guard or its equivalent. This level of protection will also include harbor patrol boats and may include water barriers able to stop most small boats.

4-8.2.3 **High Level of Protection.** The high level of protection will include both waterside electronic security systems and water barriers designed to stop most powerful small boats and provide at least 5 minutes of delay.

4-8.2.4 **Very High Level of Protection.** The very high level of protection will incorporate the same measures as the high level of protection, but the water barriers will be able to stop all but the most powerful small boats.

4-8.3 **Project Scope Implications.**

4-8.3.1 **Sitework Elements.** For this tactic, the sitework elements are water barriers as described above and exterior electronic security systems as described below.

4-8.3.2 **Building Elements.** Because the focus of this tactic is on waterside approaches, building elements are only issues to the extent that an explosive laden watercraft could get near a building or that the applicable direct fire weapons effects would impact the building construction. In those cases, refer to the sections on vehicle bombs and direct fire weapons.

4-8.2.3 **Equipment.** Equipment for this tactic includes waterside electronic security system equipment such as closed circuit television (CCTV), surface or swimmer detection, and underwater detection.

4-8.2.4 **Manpower and Procedures.** There are few facility related issues related to manpower and procedures, but there do need to be qualified people to respond to watercraft incursions, and their response time may affect the distances associated with the various zones associated with the defense in depth. There may also be facility issues relating to supporting the patrol personnel and their patrol craft.

4-8.3.5 **Expeditionary and Temporary Construction.** The same principles apply in the expeditionary environment, but the nature of the barriers and the boundary demarcation may be different in that it is likely to be of a temporary nature.

4-9 **FORCED ENTRY TACTIC.** In this tactic aggressors are assumed to force their way through building elements or barriers. Attempts to gain entry through stealth are covered under the covert entry tactic.

4-9.1 **General Design Strategy.** Based on the above assumption, the general

design strategy for this tactic is to detect aggressors either prior to their reaching barriers or as they attempt to breach them and then to provide sufficient delay to forced entry in the construction of those barriers to allow responding forces to arrive and defeat the aggressors before they can compromise the asset. Inherent in this strategy, therefore, is that there is an intrusion detection system that provides an alarm to a monitoring station in response to intrusion and that there is a response force that can respond to an alarm and reach its location before aggressors are able to breach the barriers between that point and the assets being protected.

4-9.2 Specific Design Strategies. The specific design strategies associated with the different levels of protection vary by the amount of delay provided and the sophistication of the intrusion detection. Note that the levels of protection have specific delay times associated with them. Those delay times are generalized goals, but if the planning team is confident that response times are either more or less than those associated with the applicable levels of protection, the applicable delay times may have to be adjusted. All building elements in the protective envelope that provides the delay time must provide at least the minimum delay time associated with the applicable level of protection based on the assumption that aggressors will always be able to identify the weakest element in the envelope. That protective envelope may be all in one layer, such as the shell of a room or the exterior of a building, or it may encompass multiple layers such as the building exterior and multiple rooms arrayed in rings around the asset. The detection element of the protective system may also include closed circuit television to assess the validity of alarms.

4-9.2.1 Low Level of Protection. The specific design strategy associated with this level of protection incorporates an envelope of building elements (walls, doors, windows, roofs, etc.) surrounding an asset that provides a delay time to the specified threat tools of at least 1 minute. In addition, the protective system incorporates intrusion detection sensors at all operable openings. Entry through other building elements would be detected through operational procedures, such as roving patrols.

4-9.2.2 Medium Level of Protection. The specific design strategy associated with this level of protection incorporates an envelope of building elements (walls, doors, windows, roofs, etc.) surrounding an asset that provides a delay time to the specified threat tools of at least 5 minutes. It also incorporates a complete ring of detection covering all possible approaches through the protective envelope.

4-9.2.3 High Level of Protection. The specific design strategy associated with this level of protection incorporates an envelope of building elements (walls, doors, windows, roofs, etc.) surrounding an asset that provides a delay time to the specified threat tools of at least 15 minutes. It also incorporates a complete ring of detection covering all possible approaches to the asset. That ring must include two different sensor phenomenologies covering each approach.

4-9.2.4 Very High Level of Protection. The specific design strategy associated with this level of protection incorporates the same delay and detection elements as the high level of protection, but the delay time is at least 30 minutes.

4-9.3 **Project Scope Implications.**

4-9.3.1 **Sitework Elements.** There will commonly be few sitework considerations that have any significant cost implications. The most significant issue is establishing unobstructed spaces around buildings or other enclosures housing assets, which in the case of inhabited buildings is required by the minimum standards in UFC 4-010-01. In general, sitework elements such as fences and walls, which may be considered barriers to forced entry, provide minimal delay. Therefore, they are not commonly used as part of a forced entry resistant protective system when the asset is stored within a building.

4-9.3.2 **Building Elements.** Building elements are a critical part of the protective system for protecting against forced entry, and the implications on their construction may be significant depending on the level of protection and the tools associated with the threat.

4-9.3.2.1 **New Construction.** In general, the walls and roofs will have to be more substantial than common lightweight conventional construction. In addition, the doors will be stronger and will have more robust locksets and hardware than conventional doors and windows will either be heavier and tougher or they will have external barriers. There may also have to be barriers installed over other potential man-passable openings (greater than 620 square centimeters or 96 square inches) such as air vents and utility openings.

4-9.3.2.2 **Existing Buildings.** Similar to new construction, walls and roofs will have to be more substantial than conventional construction, but in the case of existing construction, obtaining that will require retrofits of additional building materials. Windows and doors will either be replaced with forced entry resistant window and door assemblies or, in the case of windows, they may be fitted with forced entry resistant window barriers.

4-9.3.3 **Equipment.** Equipment, in the context of the design strategy for this tactic, is predominantly intrusion detection equipment. Intrusion detection systems include sensors, alarm monitoring systems, and data transmission media to get the signals from the sensors to the alarm monitoring system. The scope of the sensor application depends on the level of protection, how much space is monitored, and the kinds of sensors used. The important goal to keep in mind is that detection must occur prior to any forced entry resistant barriers for the system to work effectively.

Some locations may already have central monitoring stations; in which case, there may be opportunities to add to an existing monitoring system. In others, new monitoring stations may have to be established. Such considerations, in addition to the distance from the protected building to the monitoring station, make it difficult to easily estimate the cost implications of an intrusion detection system.

In addition to the intrusion detection system, equipment may include closed circuit television cameras to assess the alarms. In those cases, there will have

to be enough cameras to view every alarm point or zone. Another alternative is to respond to every alarm with a response force of some kind. The cameras may allow for avoidance of responses to false alarms and may provide additional information to response forces if the alarm is valid, such as how many aggressors there are and whether or not they're armed. Lastly, in many cases there may be electronic entry control systems within the scope of the project or existing in a building. That will be particularly true where the covert entry tactic applies. In those cases, the intrusion detection system may have coordinated or integrated with the entry control system. Access control does not need to be very sophisticated if only the forced entry tactic is a concern.

4-9.3.4 Manpower and Procedures. Manpower and procedures are critical elements of any protective system designed to protect against forced entry. The design of the protective system should optimally be coordinated with available manpower and local procedures, for both response and alarm monitoring. Where there are no such capabilities or where what exists is inadequate, the designers will have to work with the applicable law enforcement authorities to coordinate the system design and the procedures.

4-9.3.5 Expeditionary and Temporary Considerations. The nature of the expeditionary and temporary environment and the facilities commonly available does not commonly lend itself to sophisticated intrusion detection systems and forced entry resistant construction. There are forced entry resistant containers available, and valuable assets may be stored in other common containers, but hardening of buildings or structures is generally economically infeasible. Because of those considerations, protection against forced entry in the expeditionary and temporary environment is commonly manpower intensive, involving the use of guards. Those guards may be supplemented by intrusion detection systems such as perimeter systems or alarms on containers; however, successfully protecting assets is likely to depend on a rapid response.

4-10 COVERT ENTRY TACTIC. The underlying assumption for the covert entry tactic is that aggressors will not force entry because their goal is to employ stealth to access assets without anybody knowing they have done so. Those aggressors may be outsiders or they may be people who legitimately have access to facilities, such as employees. The latter are commonly referred to as insiders, and they provide additional challenges to designers. Covert entry and forced entry are often both included in threats to assets, in which case the designers need to coordinate the protective measures for both tactics.

4-10.1 General Design Strategy. Because the assumption inherent in protecting against this tactic is that aggressors will not attempt to force entry, the general design strategy is limited to providing construction that presents a barrier between potential aggressors and assets and then providing access control through those barriers. Where only outsiders are a concern, that approach can be applied to entire buildings or large areas of buildings. Where insiders are a concern, there may have to be compartmentalization within the building.

4-10.2 **Specific Design Strategies.** The levels of protection vary in the sophistication of the access control measures associated with them. All four level of protection involve using access control measures and construction that allows assets to be segregated from unauthorized personnel.

4-10.2.1 **Low Level of Protection.** The design strategy for the low level of protection is to prevent the use of easily duplicated identification badges as a method of covert entry.

4-10.2.2 **Medium Level of Protection.** The design strategy for the medium level of protection is to prevent the use of easily duplicated identification badges or stolen electronic access control badges as a method of covert entry. It also involves provision of protection for mechanical locking systems to prevent bypassing.

4-10.2.3 **High Level of Protection.** The design strategy for the high level of protection is to prevent the use of electronic access control cards duplicated using sophisticated electronic methods through the use of primary and secondary credential systems (i.e., card and personal identification number (PIN) or retina, signature, or voice recognition, etc.). It also involves initiating tailgating policies or installing prevention equipment and providing protection for mechanical locking systems to prevent bypassing.

4-10.2.4 **Very High Level of Protection.** The design strategy for the very high level of protection is the same as the high level of protection with the addition of providing equipment that will detect the presence of weapons or material that could be used to carry out terrorist or criminal acts.

4-10.3 **Project Scope Implications.** The project scope implications for this tactic are predominantly in access control, but there are considerations in the other common areas as well.

4-10.3.1 **Sitework Elements.** Sitework issues for the covert entry tactic where assets are stored in buildings are limited to minimizing opportunities around buildings for aggressors to hide. That goal is effectively solved for inhabited buildings by applying the unobstructed space requirements from UFC 4-010-01. The only other area where sitework considerations are an issue is where assets to which access must be controlled are stored in other than buildings. In those cases, the assets will need to be surrounded with a barrier such as a fence such that potential aggressors cannot access the assets without breaching the barriers. The assumption therein is that they will not breach barriers because it would subject them to potential detection.

4-10.3.2 **Building Elements.** The implications on project scope on building construction are limited. Because of the assumption that aggressors will not force entry through barriers, walls, floors, ceilings, and roofs surrounding asset need only be sufficiently constructed such that breaching them leaves evidence of the act. Therefore, common lightweight construction is adequate. Windows must either be capable of

being locked or be inoperable. Doors must also be lockable with door hardware that cannot be defeated without leaving evidence of the act. The only other building oriented issue is in building layout. The architectural layout of buildings will have to support separating assets into areas to which access can be controlled. This may be complicated where insider considerations must be taken into account, in which case the building layout may need to support compartmentalization. The considerations are the same for new construction and for existing buildings.

4-10.3.3 **Equipment.** This is the area where the project scope will be most affected. The primary implications in this are access control equipment, the requirements for which are summarized below. Where the threat is limited to outsiders, equipment can be provided at the building exterior or at a particular area. Where insiders are a concern, there may be access control requirements at multiple points interior to the building to support compartmentalization.

4-10.3.3.1 **Low Level of Protection.** The low level of protection requires installation of single-door mechanical or electronic access control at primary entrances and locks or internal emergency exit devices on all other doors.

4-10.3.3.2 **Medium Level of Protection.** The medium level of protection requires installation of a centralized electronic access control system capable of restricting access times for registrants and immediately removing stolen card credentials from the system. Those systems would be applied at primary entrances to controlled areas. It also requires installation of an internal intrusion detection system to detect after-hours entry and entry through access-controlled doors, emergency exit doors, and windows at all times.

4-10.3.3.3 **High Level of Protection.** The high level of protection requires installation of electronic access control with biometric recognition or a personal identification number (PIN) as a secondary credential, in conjunction with tailgating prevention measures. Tailgating is where one person enters with another person without the second person's access authority being checked, such as an unauthorized person forcing an authorized person to help him or her get access. In addition, closed circuit television may be provided to assess entry authority. The high level of protection also includes the same intrusion detection requirements as the medium level of protection.

4-10.3.3.4 **Very High Level of Protection.** The very high level of protection has the same requirements as the high level of protection with the addition of positive tailgating prevention hardware, such as turnstiles or mantraps. It also includes the application of CCTV to assess entry authority, installation of metal and explosive detectors to prevent introduction of weapons into secured areas, and the same intrusion detection requirements as the medium level of protection.

4-10.3.4 **Manpower and Procedures.** Manpower and procedures are a critical part of protection against covert entry. Designers must incorporate manpower and procedures into the system design, which involves coordination with building users and

supporting law enforcement personnel. In some cases, assigning guards to control access may eliminate the need for an access control system. For the low and medium levels of protection guards checking identification that includes photographs of authorized personnel may be adequate. In the case of the medium level of protection, however, a badge exchange procedure would have to be implemented. That procedure involves two distinct badges for each authorized person. A person entering a controlled area must surrender his or her identification to a guard who trades it for a badge that is under the guard's control. That system requires aggressors to forge both identification under their control and badges under the control of guards.

Where guards are not used to directly control access, there are still manpower requirements in that there must be procedures to respond to unauthorized entry attempts. In addition, where screening equipment is used, there will have to be personnel to operate it and procedures developed on how to operate it.

In addition, the application of the two-person rule may prevent insiders from breaching security. In the two-person rule, one person can never be alone in the vicinity of a protected asset. That way two employees would have to be co-opted to allow compromising an asset. The two-person rule can be a strictly procedural measure or it can be enforced through application of access control equipment that requires two people to provide the required credentials before access is granted.

4-10.3.5 Expeditionary and Temporary Construction. There are commonly limited opportunities to provide complex access control systems in the expeditionary and temporary environment, so the approach tends to be manpower intensive. There are opportunities to store assets in safes or containers when they are not in use. In those cases the containers need to be able to be locked with locks that cannot be defeated without leaving evidence.

4-11 VISUAL SURVEILLANCE TACTIC. The design strategy for mitigating this tactic involves preventing unauthorized people from seeing assets that users do not want to be seen.

4-11.1 General Design Strategy. The general design strategy for this tactic is simply to prevent aggressors from seeing assets.

4-11.2 Specific Design Strategy. There is only one level of protection associated with this tactic, so the specific design strategy is the same as the general design strategy. Because there is only one level of protection, either protection is provided or it is not.

4-11.3 Project Scope Implications. Project scope implications are minimal. They involve blocking sightlines to assets from areas outside of the control of the facility occupants. Identifying potential vantage points from which aggressors might observe assets is a key to the design strategy for this tactic. Once those points are identified, measures can be implemented to block those sightlines.

4-11.3.1 **Sitework Elements.** Sightlines may be blocked using such measures as walls or fences with obscuration screening. Also, vegetation such as trees can be used to block sightlines. Note that where vegetation is used, it should be a variety that maintains its foliage year-round.

4-11.3.2 **Building Elements.** Employing building elements to block sightlines to assets is the most effective means of providing protection against this tactic. One approach is to lay out buildings such that no assets subject to observation from outside the building are in exterior rooms or that windows are laid out and assets are located such that the assets cannot be viewed through the windows. Where that opportunity does not exist, it will be necessary to avoid transparent building elements (windows, doors, and skylights) or provide means to obscure vision through them. Common means to obscure vision through windows are to install reflective or tinted window treatments such as reflective fragment retention film or to use figured or translucent glazing. Another solution is to use drapes or blinds, but they require operational discipline to ensure they are closed when sensitive assets are in view. Note that where reflective films or glazings are used, they will be ineffective at night, so drapes or blinds will still have to be incorporated into the project scope. The considerations are the same for new construction and for existing buildings.

4-11.3.3 **Equipment.** There are no equipment implications associated with this tactic.

4-11.3.4 **Manpower and Procedures.** The only issue with respect to procedures for this tactic is that there will need to be procedures in place to ensure that drapes or blinds are closed when they need to be or that sensitive assets are kept away from locations where unauthorized personnel can view them.

4-11.3.5 **Expeditionary and Temporary Construction.** There are no special considerations for expeditionary and temporary construction. The same principles apply as to fixed facilities but the options for providing obscuration may be more limited.

4-12 **ACOUSTIC EAVESDROPPING.** The design strategy for mitigating this tactic involves keeping aggressors from hearing audible information from outside of controlled areas. This UFC does not address the use of covert electronic listening devices placed within buildings. That is within the scope of technical security, which is dealt with by others and is outside the scope of facility design.

4-12.1 **General Design Strategy.** The general design strategy for this tactic is to design building exteriors or rooms within buildings that have construction that attenuates sound transmission so that secure conversations can be held in the building.

4-12.2 **Specific Design Strategies.** The design strategies associated with the various levels of protection all involve providing walls, doors, window, ceiling, floor, and roof construction that provides the required sound attenuation. The only difference between levels of protection is the level of sound attenuation provided. Sound attenuation is categorized by Sound Transmission Class (STC). The STC ratings for

each level of protection and the level of sound attenuation they provide are summarized in Table 4-5.

4-12.3 Project Scope Implications. The scope of project changes is mostly limited to building construction, and then only in those areas where the building user needs to be able to have secure conversations.

4-12.3.1 Sitework Elements. The only implications to sitework design are in keeping aggressors from getting near enough to areas of buildings where secure conversations might be held. That requirement will generally be met by providing the unobstructed space required for inhabited buildings by UFC 4-010-01.

4-12.3.2 Building Elements.

4-12.3.2.1 New Construction. The scope of additional construction requirements is dependent on how much of the building needs to meet the required STC rating. Beyond that, in general, construction to meet the required STC ratings is within the scope of conventional construction. The higher STC ratings may require the use of masonry or concrete for walls and roofs for exterior construction, but they can commonly be provided through additional insulation and special construction details for interior construction. Doors and windows meeting other than the lowest STC rating in Table 4-4 will commonly have to be purchased as tested STC rated assemblies.

4-12.3.2.2 Existing Buildings. Considerations for existing buildings are similar to new construction, but retrofits to existing construction may require adding building materials to the existing walls, roofs, ceilings, and floors to achieve the applicable STC ratings. Doors and windows will have to be replaced with STC rated assemblies.

Table 4-4. STC Ratings for Levels of Protection

Level of Protection	STC Rating	Sound Attenuation
Low	30	Loud speech can be understood fairly well. Normal speech cannot be easily understood.
Medium	40	Loud speech can be heard, but is barely intelligible. Normal speech can be heard only faintly, if at all.
High	45	Loud speech can be heard only faintly, but cannot be understood. Normal speech is inaudible.
Very high	50	Very loud sounds on the order of brass musical instruments can be heard only faintly or not at all.

4-12.3.3 Equipment. There are generally no equipment requirements associated with this tactic.

4-12.3.4 Manpower and Procedures. There are limited requirements for manpower and procedures associated with this tactic, and there are none that have to

be coordinated into designs. The extent of these measures is to ensure that no unauthorized personnel are allowed to get close enough to the perimeters of secure conference rooms to listen to the secure conversations.

4-13 **ELECTRONIC EMANATIONS EAVESDROPPING.** The design strategy for mitigating this tactic involves preventing sensitive electronic emanations from being intercepted by aggressors from outside of controlled areas. Much of the specific guidance associated with mitigating this tactic involves what is known as TEMPEST protection. The requirements for TEMPEST protection are established based on TEMPEST assessments, which are performed by the applicable elements of the intelligence community. Those assessments, the criteria on which they are based, and much of the criteria on which mitigation measures are based are classified. The scope of this UFC will be to reflect the implications to construction if certain measures are specified as a result of the TEMPEST assessment.

4-13.1 **General Design Strategy.** The general design strategy for this tactic will follow one or more of the following depending on the TEMPEST assessment.

- Follow applicable information system security policy, which means no specific TEMPEST measures are required.
- Provide controlled space outside the area where sensitive information is being processed. This reflects the fact that emanations attenuate with distance.
- Provide TEMPEST shielded equipment.
- Provide separation between electrical and electronic circuits, components, and equipment that process classified and unclassified information.
- Provide TEMPEST shielded enclosures.

4-13.2 **Specific Design Strategy.** There is only one level of protection associated with this tactic for the purposes of this UFC. That reflects the fact that no requirements established within the scope of this UFC will govern which of the design strategies above are applicable. The requirements will be established through the TEMPEST assessment.

4-13.3 **Project Scope Implications.** Only two of the design strategies above have significant project scope implications. Those are described below.

4-13.3.1 **Sitework Elements.** There are generally no significant project scope implications associated with this tactic. The only one that may have implications is the establishment of controlled space. The TEMPEST assessment may result in a requirement to establish a controlled area outside a protected building, which could require additional unobstructed space beyond that required for inhabited buildings by UFC 4-010-01. It could also require that the controlled space be fenced.

4-13.3.2 **Building Elements.** Requirements established as the result of TEMPEST assessments will have the most impact on building elements.

4-13.3.2.1 **New Construction.** To a minor extent the results of TEMPEST assessments could affect building layout by establishing a need to create controlled space around an area in which classified information is processed. Generally, however, the significant implications to building elements will be where a TEMPEST shielded enclosure is required. In those cases the entire building envelope of the area in which classified information is processed will need to be constructed using specialized TEMPEST shielding. That shielding is very expensive. In addition, special doors and windows are required and any penetrations of the envelope such as utility penetrations need to have emanations filters. Another option would be to provide a modular TEMPEST shielded enclosure such as the one shown in Figure 4-12 if the area requiring shielding is small enough. Cost information in the cost appendices does not include modular enclosures.

4-13.3.2.2 **Existing Buildings.** Considerations for existing buildings are similar to new construction, but retrofits to existing construction may require adding TEMPEST shielding to the existing walls, roofs, ceilings, and floors. Doors and windows will have to be replaced with TEMPEST shielded assemblies. Alternatively, as for new construction, where the areas requiring shielding are small enough, modular TEMPEST shielded enclosures can be provided.

Figure 4-12. Modular TEMPEST Enclosure

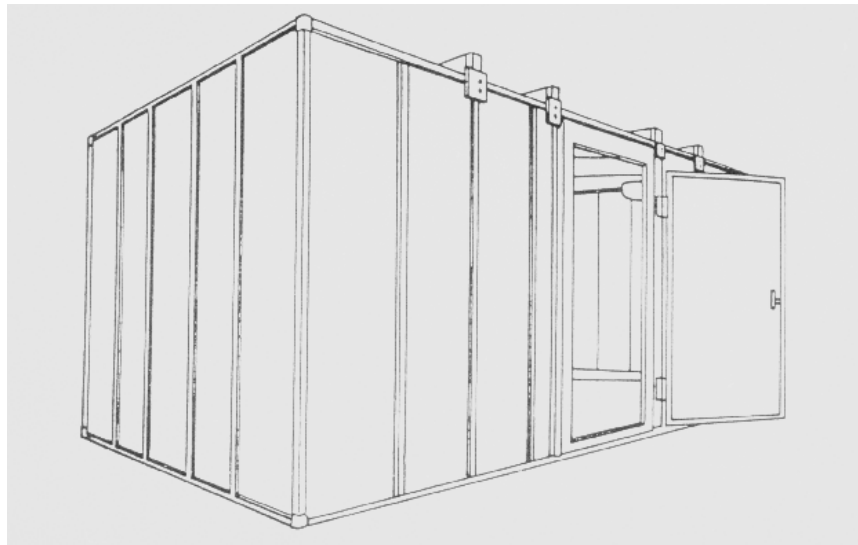

4-13.3.3 **Equipment.** Where TEMPEST shielded equipment is required as a result of the TEMPEST assessment, that equipment generally will be outside the scope of construction funding. It will commonly be installed by the users after construction is complete. The only area that has significant implications to equipment that falls within the scope of construction funding is in separation of between classified and unclassified circuits. That requirement may require additional conduit and conductor.

4-13.3.4 **Manpower and Procedures.** There may be many procedural requirements that need to be implemented as a result of the TEMPEST assessment, but they are beyond the scope of this UFC to describe and most will have limited implications to the scope of the project.

CHAPTER 5

MASTER PLANNING CONSIDERATIONS

5-1 **INTRODUCTION.** Master planning is also referred to as comprehensive planning, regional planning, land use planning, and facilities planning. For the purposes of this UFC it refers to a process by which an entity (government, base, installation etc) is concerned with documentation, planning and implementation of the long term goals, policies, and action strategies for a specific physical area. Its focus is usually long term (10-20 years) but may include near and mid-term strategies. The result is usually a “blueprint” for the physical development of a particular geographic area. Among DoD components, the master planning process is intended to provide a commander with a broad, long-term picture of facility needs and land use for an installation or base. In many ways the process is similar to the municipal planning process employed by cities in their attempts to anticipate growth and program improvements, which is appropriate because installations are effectively small cities. Each of the services has its own approach to “master planning” that is unique in terms of details, nomenclature and process, yet each attempts to provide the service with a long term policy guide for the physical development of installations. The Army and Marine Corps use the term Master Plan, and the Air Force refers to it as the General Plan. A number of land/facility planning processes are used by the Navy; however, the Regional Shore Infrastructure Planning process is the method that corresponds most closely with the recognizable master planning process.

Many security and antiterrorism objectives can be achieved through the master planning process. The least costly and often the most effective protection measures are those incorporated during this process. Implementing appropriate security and antiterrorism measures as part of master planning can preclude the need for piecemeal and costly security enhancements later on. That is particularly the case for issues relating to antiterrorism because of issues such as vehicular control and standoff distance.

It is also important to remember that the nature of the threat is ever changing. Some degree of security should be provided during master planning, with consideration given to increased or enhanced protection at times of increased threat. Security and antiterrorism objectives must be balanced with other planning objectives, such as the efficient use of land and resources, area development planning, and vehicular access and circulation, and they must take into account existing physical, programmatic, and fiscal constraints.

5-2 **SECURITY AND ANTITERRORISM PLANNING.** Security and antiterrorism planning is a parallel, but separate discipline that has its own DoD and service regulations and instructions. Security and antiterrorism requirements, responsibilities, and management controls are well defined by directives, instructions, regulations, and guides at all levels; however, those documents do not acknowledge their existence in broader based land and facility planning. Because of that, security

and antiterrorism planning and land/facilities planning are generally accomplished independently using distinctly separate processes.

DoD protective design guides, standards, criteria, and vulnerability assessment programs stand as models, and are used by agencies and organizations throughout the world to implement needed security upgrades and to improve capabilities to mitigate vulnerabilities associated with terrorist attacks and criminal acts. While security and antiterrorism requirements are being addressed in Military Construction, minor construction, and other short-term projects, there is a general lack of security and antiterrorism guidance, coordination, and communication on long term planning issues such as land use, space management, and area development. Part of the problem might be attributed to the fact that security and antiterrorism tend to be more focused on the near term and directed at individual facility planning and design. Mitigation options to patch or fix vulnerabilities are typically short-term remedies or are incorporated into new construction or major renovations, modifications, repairs, and restorations of individual facilities.

There is abundant experience that demonstrates that the incorporation of improved security, protective, and response and recovery elements into new construction and at times of major rehabilitation of facilities are factors of two to ten times less expensive than upgrading security and protective systems in operating facilities. This cost differential can be even larger when life cycle costing is analyzed because quick reaction responses typically employ larger numbers of people. Well designed solutions, incorporating new and innovative uses of appropriate technology, Crime Protection Through Environmental Design (CPTED) concepts, and other architectural elements, can maximize security while minimizing operating costs.

5-3 **ISSUES IN MASTER PLANNING.** The master planning process provides a suitable framework for long-term security and antiterrorism planning and programming. Security and antiterrorism and land/facility planning converge at several component levels of master plan development, to include the following.

5-3.1 **Land Use Planning.** In most cases, integration of antiterrorism measures at the master planning level will increase the land area needed for individual facilities. Accordingly, future land use plans must take proposed antiterrorism measures into account when calculating land area requirements. Open circulation and common spaces on an installation, which are desirable from a conventional design perspective, may be undesirable from an antiterrorism perspective. Security considerations can be integrated into planning in such a way as to complement, rather than compete with other planning elements. For example, open space provides a number of mutual benefits. If the space is impassible for vehicles such as the case of a wetland or densely vegetated area, it provides not only environmental and aesthetic amenities, but helps to prevent vehicle intrusion as well. Permeable open space allows storm water to percolate into the ground, while enhancing surveillance and standoff distances and reducing the need for culverts, drainage pipes, and other site access or concealment opportunities. Plans must also consider high risk land uses with high concentrations of

personnel, as well as off-base adjacent land use and zoning plans for potential development that may impact security of the installation. For example, planners must take into account adjacent land uses (internal and external) that could facilitate attacks or may be potential targets themselves, such as off-site roads, concealment areas for sniper attacks, or internal or external fuel storage or distribution points. Consider the following:

- When preparing land use plans, locate high-risk land uses in the interior of the installation. High-risk land uses contain high concentrations of personnel, such as administrative, community, and housing areas.
- Consolidate high-risk land uses to take advantage of opportunities for security efficiency such as minimized entry control points.
- Assess off-base adjacent land use and zoning plans for potential development that might impact security within the installation.
- When selecting a site for a facility, consider its location relative to the installation perimeter. Maximize the distance between the perimeter fence and developed areas, providing as much open space as possible inside the fence along the installation perimeter.
- When selecting a site for a facility, consider the facility design tradeoffs between the fact that elevated sites generally enhance surveillance of the surrounding area and the fact that adjacent high terrain or structures outside the base boundary may allow observation of on-base areas by outsiders.
- Recognize that dense vegetation in proximity to a facility can screen covert activity and should be avoided. Either avoid such areas or plan to remove some of the vegetation.
- Avoid low-lying topographic areas when siting facilities because airborne chemical, biological, and radiological agents, which are commonly heavier than air, can be trapped in those low-lying areas.

5-3.2 Site Planning and Space Management. Defensible space, access control, and standoff distance are key drivers in all aspects of development planning and site selection. The placement of buildings offers some challenges to security and antiterrorism and installation master planning. For example, clustering buildings or concentrating people, property, and operations in a single location increases opportunities for collateral impacts and single point vulnerabilities. On the other hand, grouping high-risk activities and concentrating personnel and critical functions in a cluster can provide opportunities for maximizing standoff distance and for creating defensible space. While the dispersal of buildings, people, and operations across an installation reduces the risk that an attack on any one location will impact others, such dispersal could have an isolating effect that reduces the effectiveness of existing

security provisions, increases the complexity of emergency response, and creates less defensible space. Tradeoffs need to be carefully considered by planners; however, as illustrated in Figure 5-1, consolidating facilities that are functionally compatible and have similar threat levels reduces the perimeter area to be protected, limits access points, and results in defensible space that can be protected more efficiently. Other development or space management considerations include:

- Consider placement, orientation, and proximity of facilities with common functional uses (operations, administrative, support, logistics, housing etc) or similar threat levels to maximize opportunities for more efficient security.
- Avoid collocating high risk operations with low risk operations.
- Avoid locating facilities considered to be high risk in areas near uncontrolled public areas.
- Consider siting facilities to maximize opportunities for observation from nearby facilities as illustrated in Figure 5-2.
- Where possible, provide separation distances of at least 10 meters (33 feet) to minimize collateral damage in an explosive or indirect fire event.
- Consider locating safe havens or collective protection facilities with appropriate protection where large numbers of people could congregate in the event of an attack such as a chemical attack.
- Where possible, isolate loading docks and mail rooms to minimize the effects of explosives detonate within them on surrounding areas and other areas within the buildings. Where possible separate loading docks from other service areas and utility mains by at least 15 meters (approximately 50 feet.) Likewise, locate mail rooms on exterior walls of buildings away from main entrances or areas containing critical utility services.

5-3.3 Vehicle Access and Circulation. Vehicle bomb threats are among the most severe terrorist threats that might be expected on an installation. Most of the mitigating measures for such attacks are applied either at entry control points or at individual buildings. There are, however, some master planning oriented considerations that can reduce requirements for countermeasures to resist these attacks.

5-3.3.1 Entry Control. Controlling which vehicles gain access through controlled perimeters and controlling what those vehicles carry is a central factor in protecting against vehicle bombs. While design of entry control points is both beyond the scope of this UFC and not specifically a master planning issue, there are significant master planning considerations in establishing entry control points. The most significant such issue is establishing the appropriate number of entry control points. That number will be based on the number of vehicles that must enter the installation or interior controlled

Figure 5-1. Consolidated vs. Separated Facilities



Figure 5-2. Opportunities for Observation from Adjacent Facilities

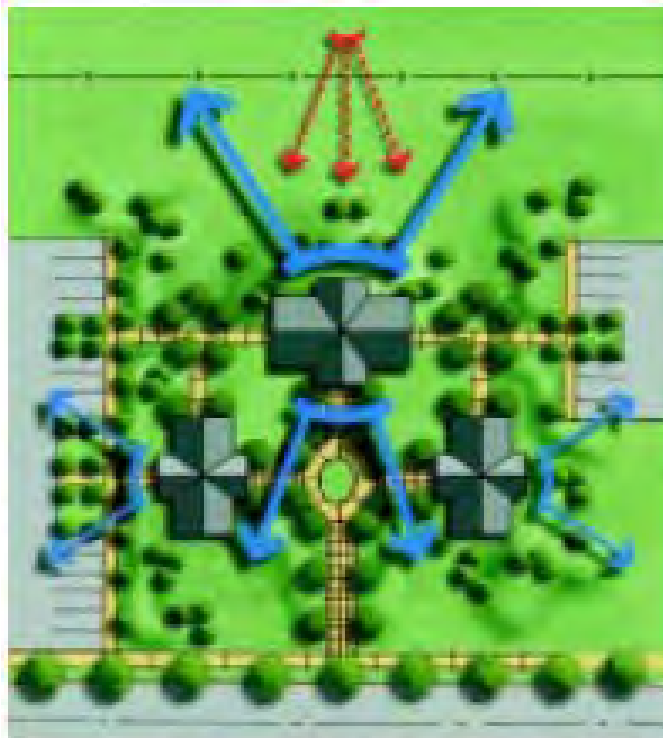

perimeter and the number of personnel available to operate them. Also, because entry control point design to accommodate large trucks is more demanding than design to support personal and similar vehicles, master planners should consider establishing separate entry control points for trucks. The remaining significant master planning issue

for entry control points is to ensure that the necessary space for them is figured into the master plan.

5-3.3.2. Vehicle Circulation. There are a number of goals relating to controlling potential threat vehicles that have master planning implications. The primary ones are keeping vehicles as far from buildings to which they might be a threat as possible, controlling their speed, and controlling their approaches. Keeping vehicles away from buildings can be addressed during site design for individual buildings, but it can also be addressed through measures such as road routings, road closures, and road restrictions, all of which have potential master planning issues. Vehicle speed can be addressed through such measures as creating curves in roads through road design, application of barriers, traffic calming devices, and traffic circles. Controlling approaches to buildings generally is done through road and parking lot configuration and closures. While parking lot entrance and layout is predominantly a facility planning issue, they can have an impact on master planning in that they may affect adjacent roads and traffic patterns. Figures 5-3 and 5-4 illustrate some of these principles of vehicle circulation through master planning. Consider the following:

- Where possible, designate centralized delivery points for commercial vehicles and limit the routes those vehicles use to access those points.
- Route roads away from buildings to which vehicle bomb threats may apply.
- Limit road access near buildings to which vehicle bomb threats may apply through road removal, road closures, and road restrictions. Figure 5-5 illustrates road closures to establish standoff distance to a building.
- Control vehicle speed by designing sharp curves into roadways through road design or placing barriers to create “serpentines,” employing traffic calming devices, or building traffic circles.
- Provide centralized parking to multiple buildings to the extent possible to maximize opportunities to provide standoff between parking and buildings.
- Eliminate straight-line approaches to buildings by rerouting or closing nearby roads and relocating parking lot entrances. See figure 5-6.
- Design parking lots to limit speed through parking layout and application of planted areas as shown in Figure 5-7.

Figure 5-3. Road Modifications to Reduce Speed



Figure 5-4. Installation Vehicle Circulation Modifications

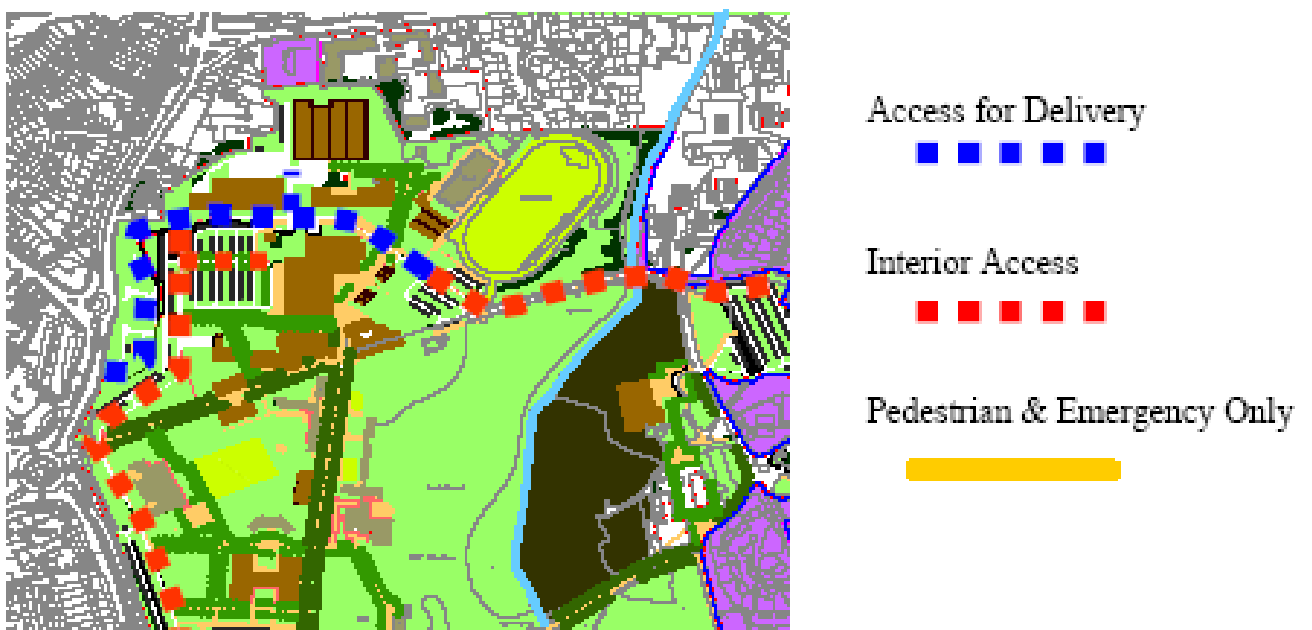

Figure 5-5. Road Closure to Create Standoff

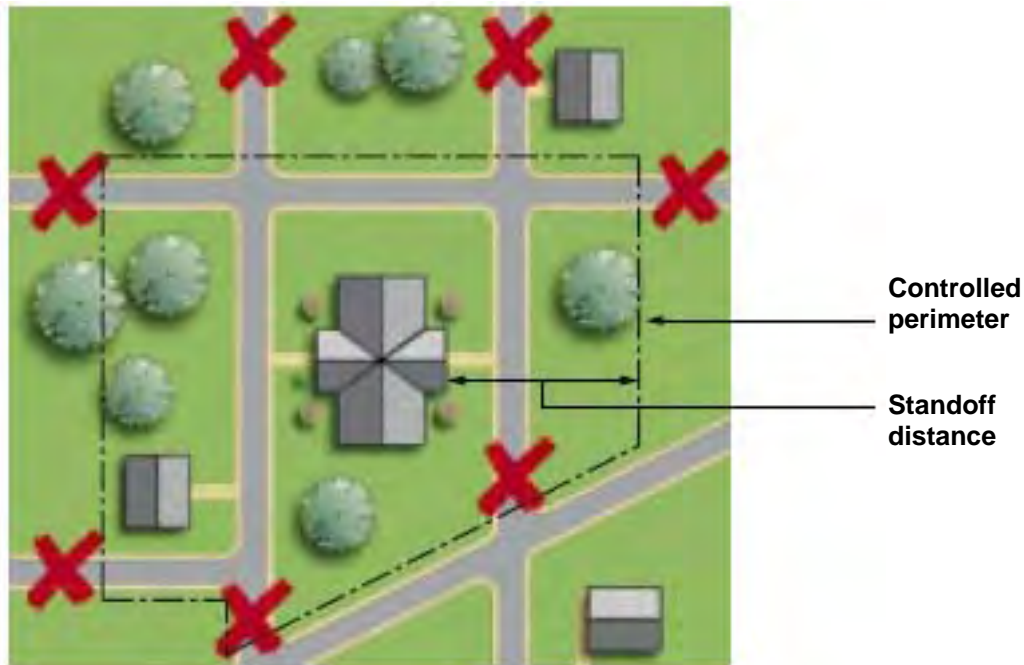
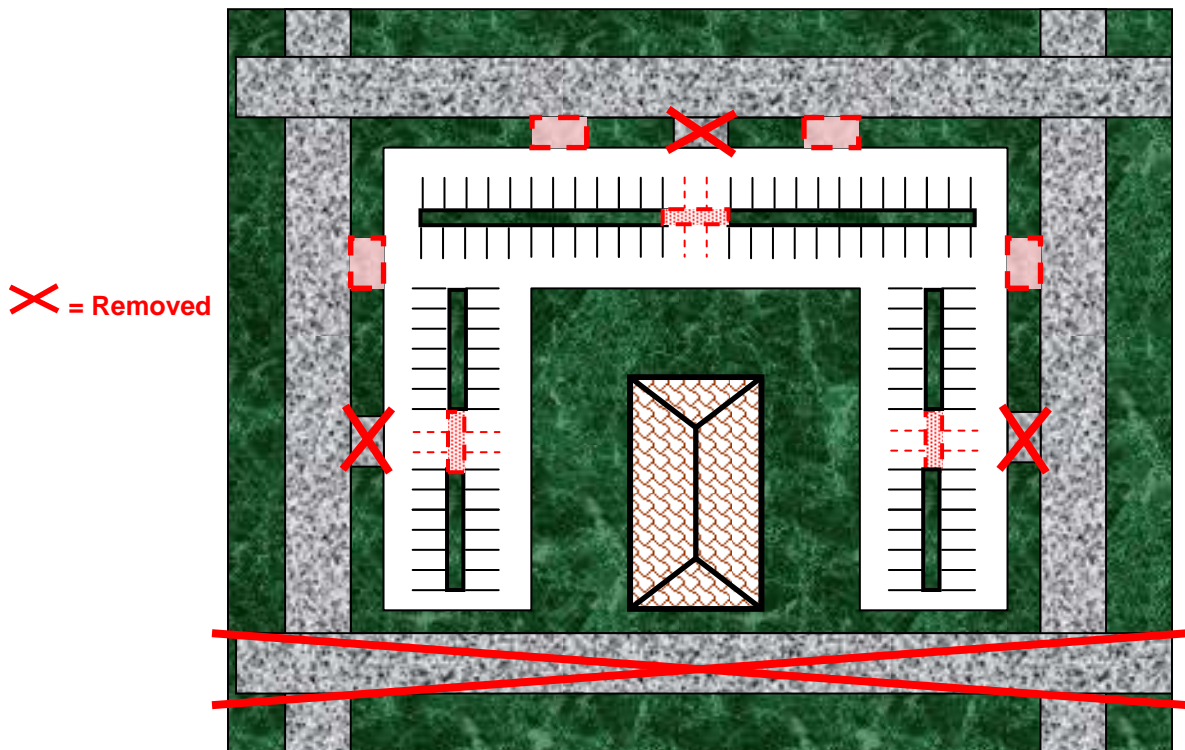

Figure 5-6. Parking and Roadway Modifications



CHAPTER 6

PROJECT COST DEVELOPMENT

6-1 **INTRODUCTION.** This UFC can be used to develop programming level cost estimates for new construction and major renovations (retrofit construction) where protection against the threats identified in this UFC is required. The costs are presented as increases (in percentages) over conventional new construction. By tabulating costs as percentage increases over common new construction, this UFC can avoid providing actual costs, which would be out of date shortly after publication. The general relationships among cost escalations of the various building components are such that the increased percentages approach is valid over time. The cost increases are currently tabulated for only the limited number of building types described below. The costs in this UFC include all labor, material, and markup costs.

6-2 **BUILDING TYPES.** The six building types addressed in the cost tables in this UFC are representative of the construction of a significant majority of the buildings built by DoD. They are selected based on their construction rather than their function. Table 3-1 lists examples of facility types that are represented by those six building types. The six building types are:

- Administrative buildings
- Medical facilities
- Dining facilities
- Barracks with internal entrances to rooms
- Barracks with external entrances to rooms
- Special structures (high bay, long span)

6-3 **BASELINE COSTS.** The baseline costs for the six building types were established by studying a significant number of buildings constructed similarly to buildings of the six types above, including buildings indicated in Table 3-1. Those baseline costs represent the common conventional construction cost for those buildings where there is an area cost factor of one. That means that construction in some areas of the United States or overseas will have to be adjusted according to the applicable area cost factors for those locations.

6-4 **NEW BUILDING CONSTRUCTION.** Use Appendix A to determine cost increases for new construction. Appendix A presents cost increases above the costs of the common conventional construction for the six building types in percentages above the baseline costs. Those increased percentages include the costs of walls, windows, doors, and roofs that are enhanced to mitigate the effects of the various threats to the applicable levels of protection. Refer to Appendix A for a description of the formulation of the cost tables for new construction. Those cost tables are for specific tactics, threat severity levels, and levels of protection. There is also guidance in Appendix A for estimating the additional costs for constructing to avoid progressive collapse.

6-5 **EXISTING BUILDING CONSTRUCTION.** Use Appendix B to determine costs for retrofits to existing construction. The costs in Appendix B are tabulated as increases over the costs of new construction. The reason for basing retrofit costs on increases over new construction costs is that the new construction costs are readily identifiable. The costs for the retrofit construction necessary to mitigate the effects of various threats to the applicable levels of protection were determined and tabulated as percentages above the cost for new construction. It is those percentages that are tabulated in Appendix B. Planning level costs, therefore, can be estimated by applying the percentages in Appendix B to costs in UFC 3-701-XX, *DoD Facilities Pricing Guide*. Refer to Appendix B for a description of the formulation of the cost tables for retrofit construction. Those cost tables are for specific tactics, threat severity levels, and levels of protection.

6-6 **SITWORK COSTS.** The countermeasures required to mitigate the effects of some tactics require barriers at some locations on the site. Those barriers can be either passive perimeter barriers or active barriers, and they can also include screens. Tables A-52 and B-52 include cost multipliers for such barriers above the cost of baseline barriers for application for new and existing construction, respectively. Those baseline barriers are 8-foot chain-link fence and a 12 foot wide (1 traffic lane) motorized 8-foot chain link gate for passive perimeter and active barriers, respectively. The baseline barriers are very common, and their costs are easy to determine using various cost estimating guides. Representing the costs as multipliers above those of the baseline barriers avoids those costs being out of date shortly after the publishing of this UFC. Experience has shown that the costs of all of the barriers in Tables A-52 and B-52 escalate at approximately the same rate, so the cost multipliers should be adequate for planning purposes indefinitely.

6-7 **DETERMINING NEW CONSTRUCTION COST INCREASES.** Use the following steps to determine the cost increases for new construction for buildings that are built similarly to one of the six building types above as reflected in Table 3-1.

6-7.1 **Determine Representative Building Type.** Determine if one of the six baseline building types above is similar in construction to the building whose cost increase needs to be determined. Refer to Table 3-1 for common facility types that fall within the six baseline building types. Also refer to Table C-2 to determine if the baseline construction of the planned building is likely to be like that for the baseline construction in the cost model in Appendix A. If the baseline is not representative, the cost model in Appendix A may be inaccurate. For example, if the planned building is in a high seismicity or hurricane zone where buildings are commonly built with reinforced concrete walls, and the baseline construction in Table C-2 is brick veneer over metal studs, the cost model in Appendix A may be unreasonably conservative. In that case, it may be possible to use Appendices A and C together to interpolate a valid cost increase. The percentages of total building costs represented by the walls, doors, windows, and roofs are tabulated in Table C-2 to assist in those interpolations.

6-7.2 **Determine Facility Baseline Cost.** For the facility being considered, determine the common cost per unit area using UFC 3-701-05 or other master planning guidance. Initially use the cost for an area cost factor of one.

6-7.3 **Find Applicable Cost Tables.** Use Table A-1 to determine which of the cost tables apply to the facility being planned based on the applicable threats and levels of protection.

6-7.4 **Find the Cost Increase.** Find the applicable cost increase (a percentage) for each applicable tactic, threat severity level, and level of protection. Where multiple tactics apply, record all increases separately for later resolution, except that where the vehicle bomb tactics and the exterior application of the hand delivered device tactic apply, use only the highest cost increase of those three tactics.

6-7.5 **Resolve Construction Components.** Use Appendix C to determine the construction represented by the cost increases tabulated in Appendix A. In some cases, the construction indicated by one tactic will be adequate to provide protection against another. There are no convenient relationships between tactics to model that generically, so the construction components will have to be examined by the user to determine if there is likely to be any redundancy. For example, if the enhancements of building components for indirect fire weapons require heavier components than for hand delivered devices or for direct fire weapons, increases for all three tactics would not be required and the larger of the increases could be used. The percentages of total building costs represented by the walls, doors, windows, and roofs are tabulated in Table C-2 for use in resolving cost increase redundancies.

6-7.6 **Determine Facility Cost Increase.** Multiply the sum of the cost increases for the applicable tactics and multiply that by the facility's unit cost. That cost will be the cost increase for the building.

6-7.7 **Record the Cost Increase.** If the cost estimate is for the purposes of preparing a DD Form 1391, enter the cost increase under Primary Facility as a lump sum under the Antiterrorism/Force Protection line item. If the cost estimate is for another purpose, document the cost increase as is appropriate for that purpose.

6-8 **DETERMINING RETROFIT CONSTRUCTION COST INCREASES.** Use the following steps to determine the cost increases for modifications to existing construction for buildings that are built similarly to one of the six building types above as reflected in Table 3-1.

6-8.1 **Determine Representative Building Type.** Determine if one of the six baseline building types above is similar in construction to the building whose cost increase needs to be determined. Refer to Table 3-1 for common facility types that fall within the six baseline building types. Also refer to Table C-2 to determine if the existing construction of the building being modified is similar to that for the baseline construction in the cost model in Appendix B. If the existing construction is not similar, the cost model in Appendix B may be inaccurate. For example, if the existing building is built

with heavy unreinforced masonry walls, and the baseline construction in Table C-2 is brick veneer over metal studs, the cost model in Appendix B may be unreasonably conservative. In that case, it may be possible to use Appendices B and C together to interpolate a valid cost increase. The percentages of total building costs represented by the walls, doors, windows, and roofs are tabulated in Table C-2 to assist in those interpolations.

6-8.2 Determine Facility Baseline Cost. For the facility being considered, determine the common cost per unit area for new construction using UFC 3-701-05 or other master planning guidance. Initially use the cost for an area cost factor of one.

6-8.3 Find Applicable Cost Tables. Use Table B-1 to determine which of the cost tables apply to the facility being planned based on the applicable threats and levels of protection.

6-8.4 Find the Cost Increase. Find the applicable cost increase (a percentage) for each applicable tactic, threat severity level, and level of protection. Where multiple tactics apply, record all increases separately for later resolution, , except that where the vehicle bomb tactics and the exterior application of the hand delivered device tactic apply, use only the highest cost increase of those three tactics..

6-8.5 Resolve Construction Components. Use Appendix C to determine the construction represented by the cost increases tabulated in Appendix B. In some cases, the construction indicated by one tactic will be adequate to provide protection against another. There are no convenient relationships between tactics to model that generically, so the construction components will have to be examined by the user to determine if there is likely to be any redundancy. For example, if the enhancements of building components for indirect fire weapons require heavier components than hand delivered devices or for direct fire weapons, increases for all three tactics would not be required and the larger of the increases could be used. The percentages of total building costs represented by the walls, doors, windows, and roofs are tabulated in Table C-2 for use in resolving cost increase redundancies.

6-8.6 Determine Facility Cost Increase. Multiply the sum of the cost increases for the applicable tactics and multiply that by the facility unit area cost for new construction. That cost will be the cost for the building modifications.

6-8.7 Record the Cost Increase. If the cost estimate is for the purposes of preparing a DD Form 1391, enter the cost increase under Primary Facility as a lump sum under the Antiterrorism/Force Protection line item. If the cost estimate is for another purpose, document the cost increase as is appropriate for that purpose.

6-9 DETERMINING SITEWORK COSTS. Where barriers are needed to mitigate the effects one or more tactics, follow the steps below to determine the costs of those barriers. Barrier costs are the same for new construction and for additions to existing facilities because it is assumed that such sitework elements will always be

added to a project as opposed to modifying existing barrier construction.

6-9.1 Identify Applicable Tactic and Threat Severity Level. Determine whether the barriers needed are for the moving or stationary vehicle bomb tactic or if they are screening to mitigate direct fire weapons. In addition, if the moving vehicle tactic applies, identify the applicable threat severity level. The threat severity level will establish which vehicle must be stopped. For planning purposes, all vehicles are assumed to be able to achieve a speed of 50 miles per hour. That assumption will result in a conservative cost estimate that may be adjusted during the design process through effective site design.

6-9.2 Identify Costs of Baseline Barriers. Identify the costs of the 8-foot high chain link fence or 12-foot wide, 8-foot high motorized chain link gate for passive or active barriers, respectively. Those costs can be found in cost estimating guides or local costs for those components may be well known. In the latter case, if the local costs are greater than costs for an area cost factor of one, ensure the area cost factor is not added again in the planning documents or adjust the baseline cost by the area cost factor.

6-9.3 Find Applicable Barrier Multiplier. Use Table A-52 or B-39 to determine the appropriate cost multipliers for passive perimeter barriers based on the applicable tactic and level of protection. Do the same for active barriers if they are to be used.

6-9.4 Identify the Applicable Quantities. Identify the applicable perimeter along which perimeter barriers are required and identify the number of traffic lanes for which active barriers will be needed.

6-9.5 Determine Barrier Costs. Multiply the appropriate cost multipliers by the costs of the applicable baseline barriers and multiply that product by the length of the perimeter or the number of traffic lanes that will require barriers, as applicable.

6-9.6 Record Barrier Costs. If the cost estimate is for the purposes of preparing a DD Form 1391, enter the barrier costs under Supporting Facilities as a lump sum under the Antiterrorism/Force Protection line item. If the cost estimate is for another purpose, document the cost increase as is appropriate for that purpose.

6-10 EXAMPLE PROBLEM. The following is an example problem demonstrating how the cost tables are applied for a new construction project. The facility that is being programmed is an 8000 square foot Field Operations Facility whose baseline cost is \$162 per square foot. The standoff distance from the building is 100 feet, resulting in a perimeter of 1160 feet, and there will need to be 2 one-lane entries through the perimeter. There is an unobstructed space around the facility of 10 meters. There is a loading dock (10 ft. x 22 ft.) and an entry lobby (15 ft. x 30 ft.) for the building, but no mail room. There is an 18 ft. x 24 ft. internal room that houses assets to which there is a forced entry threat. The design criteria include the following threats:

- Moving vehicle bomb threat at high threat severity level and medium level of protection
- Stationary vehicle bomb tactic at high threat severity level and medium level of protection.
- Hand delivered device tactic at high threat severity level and medium level of protection.
- Direct fire weapon tactic at high threat severity level and high level of protection.
- Forced entry tactic at high threat severity level and medium level of protection. The target asset for this tactic is limited to a single interior room.

6-10.1 **Building Cost Increase.**

6-10.1.1 **Determine Representative Building Type.** By referring to Table 3-1, the field operations facility can be seen to fall under the general category of an administrative building based on its construction.

6-10.1.2 **Determine Facility baseline Cost.** The baseline cost was given in the problem statement as \$162 per square foot. Assume the baseline construction given in Appendix C is applicable to this building, so the tables in Appendix A can be used. Assume the baseline interior construction to cost \$60 per square foot.

6-10.1.3 **Find Applicable Cost Tables.** The following are the applicable tables for the various tactics (Table A-1):

- For both the moving vehicle and stationary vehicle tactics, use Table A-15.
- For the hand delivered devices tactic, use Table A-3 for the exterior of the building, Table A-29 for the loading dock, and Table A-31 for the entry lobby.
- For the direct fire weapons tactic, use Table A-38.
- For the forced entry tactic, use Table A-48 (interior room).

6-10.1.4 **Find the Cost Increases.** The following are the applicable cost increases for the various tactics.

- For the moving and stationary vehicle tactics, the increase is 30.6% for the administrative facility Construction Type for 100 foot standoff (30.5 m).
- For the hand delivered devices tactic, assume the standoff distance to the building is the limit of the unobstructed space, 10 meters. In that case, the

increased building cost will be 28.5%.

- For the hand delivered device at the loading dock, the cost increase to enhance the construction of the small loading dock is 1.5% of the cost of the whole building (medium LOP).
- For the hand delivered device in the entry lobby, the cost increase to enhance construction of the entry lobby is 1.7% of the cost of the whole building (medium LOP).
- For the direct fire weapons tactic, the cost is 37.7% (high LOP).
- For the forced entry tactic, the cost increase is 1.4%.

6-10.1.5 Resolve Construction Components. Looking at the construction component identifiers in the applicable tables in Appendix A and using the appropriate tables in Appendix C results in the enhanced construction indicated in Table 6-1. The vehicle bomb tactics and the external hand delivered devices tactic both will affect the exterior of the building. Note that the cost increase for the vehicle bombs is higher than that for the hand delivered device. In comparing the walls, those required for the hand delivered device are thicker than those for the vehicle bombs, but they are reinforced CMU instead of reinforced concrete and they have moderate instead of heavy reinforcement, so they will be less expensive. That can be verified by noting that in table C-3 the 200 mm heavily reinforced concrete wall is above the 300 mm moderately reinforced CMU wall. The construction in that table is arranged from most expensive at the top to least expensive at the bottom. Also note that the other components for the vehicle bomb tactics are heavier than those for the hand delivered device tactic, so the vehicle bomb tactic can be validated to control between those two tactics. Further comparison between the vehicle bomb tactics and the direct fire weapon tactic shows the direct fire weapon cost increase being higher, but in examining the building components, only the windows seem to be heavier for the direct fire weapon tactic. Because there is no easy way using these tables to determine the relative contribution of individual building components to the total cost increase, use the higher of the two cost increases (37.7%), which will ensure that all the necessary costs are covered. The other tactics do not need to be resolved because they relate to separate internal spaces.

6-10.1.6 Determine Facility Cost Increase. The following calculations show the total cost increase necessary to accommodate the requirements for mitigating the effects of all tactics (rounded to the nearest \$1000):

- Building Exterior: $37.7\% \times (\$162 \text{ per square foot} \times 8000 \text{ square feet}) = \$489,000$
- Loading Dock: $1.5\% \times (\$162 \text{ per square foot} \times 8000 \text{ square feet}) = \$19,000$

- Entry Lobby: 1.7% x (\$162 per square foot X 8000 square feet) = \$22,000
 - Secure Room: 1.4% x (\$162 per square foot X 8000 square feet) = \$18,000
- Total: \$548,000

6-10.1.7 **Record the Cost Increase.** The total cost increase for the building (\$548,000) would be entered as a lump sum on a separate line item for Antiterrorism Measures under the Primary Facility if a DD Form 1391 was being prepared.

Table 6-1. Example Problem Building Components

Tactic				
	Wall	Window	Door	Roof/Ceiling
Vehicle Bombs (From Table C-3)	200 mm heavily reinforced concrete	1/4" + 4 x 5/32" glass + 3 x 0.045 in PVB	25 psi blast door	20K10 L=30', B=6'
Hand Delivered Devices (external) (From Table C-3)	300 mm moderately reinforced CMU	1/4" + 2 x 5/32" glass + 0.060 in PVB	Hollow metal with backer wall	20K10 L=30', B=6'
Hand Delivered Devices (Loading Dock) * (From Table C-7)	24-inch moderately reinforced concrete	None	-	27-inch heavily reinforced concrete
Hand Delivered Devices (Lobby)* (From Table C-7)	14-inch moderately reinforced concrete	None	-	14-inch heavily reinforced concrete
Direct Fire Weapons (From Table C-10)	8-inch fully grouted CMU	1-5/8 inch laminated glass with 1/4 inch polycarbonate	Industrial door with 11/16 inch armor plate	No special construction
Forced Entry * (From Table C-12)	8-inch grout filled CMU with #6 bars at 4 inches vertically and at 8 inches horizontally	None	12 gage hollow metal filled with lightweight fireproofing	7-inch reinforced concrete with 6x6 welded wire mesh, 10 gage steel deck
* Note: Internal construction not affecting other components				

6-10.2 **Barrier Costs.** Only the vehicle bomb tactics have any barrier requirements in this example.

6-10.2.1 **Identify Applicable Tactic and Threat Severity Level.** Both the moving and stationary vehicle bomb tactics apply, but the threat severity level is only an issue for the moving vehicle bomb, for which the threat severity level is high.

6-10.2.2 **Identify Costs of Baseline Barriers.** The baseline barrier costs are for 8-foot chain link fence and motorized gates. Those costs can be found in common cost engineering guides. Assume for the purpose of this problem that the cost of the chain link fence is \$15 per linear foot (lf) and the cost of the gates is \$5000 per traffic lane.

6-10.2.3 **Find Applicable Barrier Multiplier.** From Table A-52, the cost multipliers for perimeter barriers and active barriers for the high threat severity level of the moving vehicle bomb tactic are 5.0 and 7.4, respectively. Note that the costs for the stationary vehicle bomb tactic are less, so the requirements to mitigate the effects of the moving vehicle bomb will control the barrier costs.

6-10.2.4 **Identify the Applicable Quantities.** The problem statement says that the site perimeter is 1160 feet and there need to be two one-lane entries, which would require active barriers.

6-10.2.5 **Determine Barrier Costs.** The following calculations show the total costs for barriers for this problem:

- Perimeter Barriers: $5.0 \times \$15 \text{ per lf} \times 1160 \text{ lf} = \$87,000$
- Active Barriers: $7.4 \times \$5000 \text{ per lane} \times 2 \text{ lanes} = \underline{\$74,000}$

Total: \$161,000

6-10.2.6 **Record Barrier Costs.** The total cost for barriers would be entered as a lump sum on a separate line item for Antiterrorism Measures under the Supporting Facilities if a DD Form 1391 was being prepared. Information as it would be entered onto the front page of a DD Form 1391 is illustrated in Table 6-2.

Table 6-2. Illustrative DD Form 1391 Front Page Cost Presentation

ARMY		2013		3 DEC 2007
FORT ANYWHERE USA			CIDC Field Operations Facility	
PRIMARY FACILITY				1,787
Field Operations Facility	SF	8000	142	1,136
Special Foundations	SF	8000	12.55	101
EMCS Preparation / Install	SF	8000	0.73	6
IDS Preparation / Install – Arms Room	SF	600	1.19	2
Building Information Systems	LS	--	--	62
Antiterrorism / Force Protection	LS	--	--	548
SUPPORTING FACILITIES				1,435
Electric Service	LS	--	--	85
Water, Sewer, Gas	LS	--	--	58
Steam and/or Chilled Water Distribution	LS	--	--	44
Paving, Walks, Curbs and Gutters	LS	--	--	425
Storm Drainage	LS	--	--	62
Site Improvements (200) Demo (376)	LS	--	--	576
Information Systems	LS	--	--	24
Antiterrorism / Force Protection	LS	--	--	161
ESTIMATED CONTRACT COST				3,290
CONTINGENCY PERCENT (5.00%)				165
SUBTOTAL				3,455
SUPERVISION, INSPECTION, AND OVERHEAD (5.7%)				197
TOTAL REQUEST				3,652
TOTAL REQUEST ROUNDED				3,700
INSTALLED EQUIPMENT – OTHER APPROPRIATIONS				22

GLOSSARY

ACRONYMS:

A_v	Asset Value
AA&E	Arms, Ammunition, and Explosives
AFCESA	Air Force Civil Engineering Support Agency
ANSI	American National Standards Institute
BCE	Base Civil Engineer
CARVER	Criticality, Accessibility, Recuperability, Vulnerability, Effect, and Recognizability
CCB	Construction Criteria Base
CCI	Controlled Cryptographic Items
CCTV	Closed Circuit Television
CMU	Concrete Masonry Unit
DBT	Design Basis Threat
DEA	Drug Enforcement Agency
DoD	Department of Defense
DPW	Directorate of Public Works
DSHARPP	Demography, Symbolism, History, Accessibility, Recognizability, Population, Proximity
EOD	Explosive Ordnance Disposal
FPCON	Force Protection Condition
HEPA	High Efficiency Particulate Air
HVAC	Heating, Ventilating, and Air Conditioning
IDS	Intrusion Detection System

IED	Improvised Explosive Device
IID	Improvised Incendiary Device
Kg	Kilogram
kPa	Kilopascal
Lbs	Pounds
LHA	Amphibious Helicopter Assault
LHD	Amphibious Helicopter Dock
LOP	Level of Protection
mm	millimeter
MS-13	Mara Salvatruche
MSC	Military Sealift Command
MSHARPP	Mission, Symbolism, History, Accessibility, Recognizability, Population, and Proximity
NAVFAC	Naval Facilities Engineering Command
P_E	Protection Effectiveness Factor
P_I	Initial Protection Factor
P_{IAVG}	Average Initial Protection Factor
PIN	Personal Identification Factor
POL	Petroleum, Oil, and Lubricants
PVB	Polyvinyl-Butyral
PSI	Pounds per square inch
R	Risk Level
RAVA	Risk Analysis Vulnerability Assessment
RDT&E	Research, Development, Test, and Evaluation

SBX	Sea Based X-Band Radar
SEA	Southeast Asia
SSBN	Subsurface Ballistic Nuclear
STC	Sound Transmission Class
T_E	Threat Effectiveness Factor
T_L	Threat Likelihood Factor
T_{LH}	Highest Threat Likelihood Factor (for aggressor group)
TIC	Toxic Industrial Chemical
TIM	Toxic Industrial Materials
TNT	Tri-nitro Toluene
UFC	Unified Facilities Criteria
UL	Underwriters Laboratories
USACE	United States Army Corps of Engineers
USEUCOM	United States European Command
USCENTCOM	United States Central Command

TERMS:

Area Cost Factor. A multiplier by which facility costs can be multiplied to account for increases in local construction costs based on labor, materials, and equipment costs for specific localities.

Access control. For the purposes of this document, any combination of barriers, gates, electronic security equipment, and/or guards that can deny entry to unauthorized personnel or vehicles.

Active vehicle barrier. A vehicle barrier that must be manually or automatically deployed in response to detection of a threat.

Aggressor. Any person seeking to compromise an asset. Aggressor categories include protesters, criminals, terrorists, and subversives.

Aggressor group. For the purposes of calculating risk, broad groupings of aggressors who exhibit similar threat characteristics.

Antitank weapons. For the purposes of this document, shoulder fired, direct fire weapons consisting of a rocket propelled projectile with a conical shaped charge warhead that are designed to perforate the armor of armored vehicles.

Antiterrorism. Defensive measures used to reduce the vulnerability of individuals and property to terrorist acts, to include limited response and containment by local military and civilian forces.

Assessment. Visual verification of the validity of an alarm from an electronic security system.

Assessment zone. In waterfront security, the area well beyond the government's property line.

Asset. A resource requiring protection.

Asset value rating. A measurement of the importance of an asset to its user.

Baseline cost. The common conventional construction cost of an element or a building.

Biological agents. Pathogens and toxins that can be used to contaminate air or water.

Breaching. Making a hole completely through a building surface through the use of tools or explosives.

Building elements. Components of buildings and countermeasures associated directly with building interiors and exterior surface features.

Building hardening. Enhanced conventional construction that mitigates threat hazards where standoff distance is limited. Building hardening may also be considered to include the prohibition of certain building materials and construction techniques.

Chemical Agents. Chemicals, including toxic industrial chemicals, toxic industrial materials, and military chemical agents that can be used to contaminate air or water.

Collective protection. Establishment of an area of a building where personnel can work or shelter during release of a chemical, biological, or radiological agent.

Combatant command. A unified or specified command with a broad continuing mission under a single commander established and so designated by the President, through the Secretary of Defense and with the advice and assistance of the Chairman

of the Joint Chiefs of Staff. Combatant commands typically have geographic or functional responsibilities. See also specified command; unified command.

Controlled perimeter. A physical boundary at which vehicle access is controlled at the perimeter of an installation, an area within an installation, or another area with restricted access. A physical boundary will be considered as a sufficient means to channel vehicles to the access control points. At a minimum, access control at a controlled perimeter requires the demonstrated capability to search for and detect explosives. Where the controlled perimeter includes a shoreline and there is no defined perimeter beyond the shoreline, the boundary will be at the mean high water mark.

Critical Asset. Any facility, equipment, service or resource considered essential to DoD operations in peace, crisis, and war and warranting measures and precautions to ensure its continued efficient operation, protection from disruption, degradation, or destruction, and timely restoration. Critical assets may be DoD assets or other government or private assets, DoD O-2000.12-H. (e.g. industrial or infrastructure critical assets), domestic or foreign, whose disruption or loss would render DoD critical assets ineffective or otherwise seriously disrupt DoD operations. Critical assets include traditional "physical" facilities and equipment, non-physical assets (such as software systems), or "assets" that are distributed in nature (such as command and control networks, wide area networks or similar computer-based networks).

Critical Infrastructure. Infrastructure deemed essential to DoD operations or the functioning of a Critical Asset.

Design Basis Threat. The threat upon which a system of countermeasures protecting assets is based. The design basis threat includes the aggressor tactics and the associated weapons, explosives, tools, and agents.

Direct fire weapons. A weapon that is fired from a distance directly at a target and which requires an unobstructed line of sight from the weapon to the target.

Design criteria. For the purposes of this document, the basis for defining a protective system that mitigates vulnerabilities to assets. Design criteria include assets, threats, levels of protection, and design constraints.

Dirty bomb. A bomb that combines conventional explosives with radioactive materials in the form of powder or pellets that are dispersed by the explosion to contaminate a wide area. (Also known as a Radiological Dispersal Device.)

Energy absorption screen. A vertical or horizontal surface placed at a standoff distance from a target that reduces the energy of a projectile to limit its effect on the target.

Engagement zone. In waterfront security, the area between a line of floating barriers and an asset.

Entry Control Point. A continuously or intermittently manned station at which entry through a perimeter is controlled.

Equipment. As part of a protective system, countermeasures such as an electronic security system elements and other devices used by personnel for detection and assessment of threats or weapons, tools, explosives, or chemical, biological, or radiological agents.

Exclusive standoff zones. A controlled area surrounding a facility into which only service and delivery vehicles and other vehicles that must be allowed access within the perimeter are allowed. The perimeter of this area is defined by perimeter barriers and is set at a standoff distance sufficient to reduce the blast effects of vehicle bomb detonations on the protected facility.

Expeditionary construction. Construction that commonly built in forward areas and that is intended to be used for no more than 1 year after it is erected. Common structures typically include tents, Small and Medium Shelter Systems, Expandable Shelter Containers (ESC), ISO and CONEX containers, and General Purpose (GP) Medium tents and GP Large tents, etc.

Explosive safety. The practice of providing the maximum possible protection to personnel and property, both inside and outside the installation, from the damaging effects of potential accidents involving DoD ammunition and explosives.

Force Protection Conditions (FPCONs). A DoD-approved system that standardizes the Departments' identification and recommended preventive actions and responses to terrorist threats against U.S. personnel and facilities. This system is the principle means for a commander to apply an operational decision on how to protect against terrorism and facilitates inter-Service coordination and support for antiterrorism activities.

Fragment. For the purposes of developing protective systems, pieces of the materials surrounding an explosive that may be propelled at high velocity toward a building or other target as a result of an explosion of a bomb or a warhead.

General design strategy. The basic approach to developing a protective system to mitigate the effects of a given tactic. It governs the general application of construction, building support systems, equipment, manpower, and procedures.

Historic preservation. Protection afforded to districts, sites, buildings, structures, or objects listed on or eligible for inclusion on the National Register of Historic Places in accordance with the National Historic Preservation Act (Public Law 89-665 as amended; 16 USC 470 et seq)

Incendiary devices. Devices designed to spread fire.

Indirect fire weapons. Weapons that are designed to propel projectiles over obstacles, potentially over long distances, to effectively target assets where there are no clear lines of sight.

Inhabited facilities. Buildings or portions of buildings routinely occupied by 11 or more DoD personnel and with a population density of greater than one person per 40 gross square meters (430 gross square feet). This density generally excludes industrial, maintenance, and storage facilities, except for more densely populated portions of those buildings such as administrative areas. The inhabited building designation also applies to expeditionary and temporary structures with similar population densities. In a building that meets the criterion of having 11 or more personnel, with portions that do not have sufficient population densities to qualify as inhabited buildings, those portions that have sufficient population densities will be considered inhabited buildings while the remainder of the building may be considered uninhabited, subject to provisions of these standards. An example would be a hangar with an administrative area within it. The administrative area would be treated as an inhabited building while the remainder of the hangar could be treated as uninhabited. (Note: This definition differs significantly from the definition for inhabited building used by DoD 6055.9-STD and is not construed to be authorization to deviate from criteria of DoD 6055.9-STD.)

Level of protection. The degree to which an asset (e.g., a person, a piece of equipment, or an object, etc.) is protected against injury or damage from an attack.

Likelihood rating. A number between 0 and 1 that measures how likely an aggressor is to attempt to compromise a given asset.

Manpower. Countermeasures that relate to the use of guards or other personnel necessary to implement or operate elements of the protective system.

Military chemical agents. Liquid, gaseous, or aerosolized chemical agents designed for use in military weapons.

Minimum standoff distance. A standoff distance less than the Conventional Construction Standoff Distance at which the required level of protection can be shown to be achieved through analysis or can be achieved through building hardening or other mitigating construction or retrofit.

Overpressurization class. A measure of collective protection capability based on event duration and wind speed.

Passive Perimeter barriers. Vehicle barriers that are permanently deployed and do not require a response to be effective and fences, walls, screens, landforms, and lines of vegetation applied along an exterior perimeter used to obscure vision, hinder personnel access, or hinder or prevent vehicle access.

Penetration. Relating to bullets or fragments, entry into a material without passing all the way through.

Perforation. Relating to bullets and fragments, passing all the way through a material.

Planning team. A team of people with responsibilities relating to a project that is formed to develop design criteria and review material from all phases of the design process.

Predetonation screen. A fence, wall, or screen that causes an antitank round to detonate before it reaches its target. When placed at the proper distance for the facility construction, the screen will prevent penetration of the facility exterior by the antitank round.

Protective system. An integrated system of countermeasures designed to protect assets against threats to specific levels of protection. Protective systems include building elements, sitework elements, equipment, and manpower and procedures.

Protection Effectiveness factor. A number between 0 and 1 that reflects the effectiveness of countermeasures in mitigating the vulnerabilities associated with a given threat.

Procedures. Countermeasures that relate to actions taken by people, including guards and building occupants, to implement or operate elements of the protective system.

Risk. A means to quantify the combined issues of the value of an asset or the impact of its loss, the likelihood of the asset being attacked, and the effectiveness of the protection afforded the asset that can be used as a tool in making decisions about asset protection.

Risk analysis. The process of determining risk levels for assets.

Risk management. The process of evaluating how changes in countermeasures application affect risk levels and costs for the purpose of decision making.

Risk level. A number between 0 and 1 that reflects the product of asset value, aggressor likelihood, and protection effectiveness.

Shielding walls. Walls designed to intercept and resist fragment penetration and possibly to attenuate blast effects.

Sitework elements. Countermeasures that are applied beyond 1.5 meters (5 feet) from a building, excluding countermeasures categorized under equipment.

Sound Transmission Class. A numerical evaluation of an assembly's effectiveness in isolating airborne sound transmission.

Spall. The condition in which pieces of a material are broken loose from the inner surface of a wall, roof, or similar element by tensile forces that are created when a compression shock wave travels through the body and reflects from the surface.

Specific design strategy. The approach to applying general design strategies based on the applicable levels of protection.

Standoff distance. A distance maintained between a building or portion thereof and the potential location for a weapon or explosive detonation.

Surreptitious entry. A method of entry, such as lock manipulation or radiological attack on a combination lock, which would not be detectable during normal use or during inspection by a qualified person.

Sustainable design. The design, construction, operation, and reuse/removal of the built environment (infrastructure and buildings) in an environmentally and energy efficient manner. (Synonymous with Sustainable Design is "Green Building.")

Tactics. The specific methods of achieving the aggressor's goals to injure personnel, destroy assets, or steal materiel or information.

Terrorist Threat Level. An intelligence threat assessment of the level of terrorist threat faced by U.S. personnel and interests. The assessment is based on a continuous intelligence analysis of a minimum of four elements: terrorist group operational capability, intentions, activity, and operational environment. There are four threat levels: LOW, MODERATE, SIGNIFICANT, and HIGH. Threat levels should not be confused with FPCONs. Threat level assessments are provided to senior leaders to assist them determine the appropriate local FPCON.

TEMPEST. An unclassified short name referring to investigations and studies of compromising emanations. It is sometimes used synonymously for the term "compromising emanations"; e.g., TEMPEST tests, TEMPEST inspections.

TEMPEST Shielding. Shielding (commonly metallic) that attenuates compromising emanations.

Temporary construction. Construction with an expected occupancy of 3 years or less. Common structures typically includes wood frame and rigid wall construction, and such things as Southeast Asia (SEA) Huts, hardback tents, ISO and CONEX containers, pre-engineered buildings, trailers, stress tensioned shelters, Expandable Shelter Containers (ESC), and Aircraft Hangars (ACH).

Threat Effectiveness rating. A number between 0 and 1 that reflects the capabilities of aggressors to find weaknesses in security measures and to exploit them considering their sophistication, motivation, and risk acceptance.

Threat zone. In waterfront security, the area between the government's property line and the line of floating barriers.

TNT equivalent weight. The weight of TNT (trinitrotoluene) that has an equivalent energetic output to that of a different weight of another explosive compound.

Toxic Industrial chemicals. Liquid, particulate, and gaseous chemicals used in commercial and industrial applications.

Toxic Industrial materials. Liquid, particulate, and gaseous materials used in commercial and industrial applications.

Unobstructed space. Space within 10 meters (33 feet) of an inhabited building that does not allow for concealment from observation of explosive devices 150 mm (6 inches) or greater in height.

Vulnerability. Any weakness in the design or operation of a protective system for an asset that can be exploited by an aggressor to disrupt, damage, destroy, injure, or otherwise compromise the asset.

Warning zone. In waterfront security, the area just outside the government's property line.

APPENDIX A

NEW CONSTRUCTION COST TABLES

A-1 **INTRODUCTION.** The purpose of the tables in this appendix is to provide planning level estimates of cost increases for new construction of buildings representative of those commonly built by the Department of Defense. The costs tabulated are increases (in percentage of baseline cost) over the common conventional construction for those building types or rooms within buildings of those types.

A-2 **NAVIGATING THE TABLES.** Table A-1 provides a guide to locating the cost tables for various threats. It is organized by tactic, threat severity level, and level of protection for all but the hand delivered devices and forced entry tactics. For the hand delivered devices tactic, the costs are tabulated by external attack, attacks on interior spaces for improvised incendiary devices, and attacks on mail rooms, loading docks, and entrance areas using different explosive weights.

A-3 **BUILDING COMPONENT COST FORMULATION.** The cost tables were formulated by arraying a number of components that would meet the requirements of mitigating the effects of particular tactics to the applicable threat severity levels and levels of protection. Those components were then sorted based on cost, and the least cost components were entered into a building cost model. That building cost model included the baseline costs of the building components that were found to be commonly used for those buildings and that were representative of the building components that are in military construction pricing guidance. The costs in these tables are for an area cost factor of one.

The additional costs for the enhanced construction components over the conventional component costs were determined as a percentage increase over conventional costs. The percentages of the building cost represented by each of the components were built into the model; therefore, the percentage increase in the total building costs represented by the enhanced building components could be determined. It is those cost increases that are tabulated.

Note that in the case of administrative buildings the cost increases are often very high. That is due to the fact that those buildings commonly have a high percentage of windows. Replacement windows to provide levels of protection against many of the threats covered by this UFC are very costly. Reducing window areas in those buildings may be an effective way to reduce costs; however, this appendix does not directly support determining those cost reductions.

A-4 **PROGRESSIVE COLLAPSE COSTS.** UFC 4-010-01, *DoD Minimum Antiterrorism Standards for Buildings*, requires that all inhabited buildings three stories or greater in height must be designed to resist progressive collapse. The following costs should be added to buildings of three or more stories in addition to any other costs

arising out of this appendix. Because detailed guidance for application of those costs have not been developed, use the highest costs in the applicable ranges below:

- Framed structures
 - Very Low and Low Levels of Protection: 0.13 – 0.74%
 - Medium and High Levels of Protection: 0.32 – 2.74%
- Shear wall type construction
 - Masonry wall / reinforced concrete slab floor construction: 1.29% to 2.80%
 - Timber construction: 5.01% to 6.11%

A-5 **SITWORK COST MULTIPLIERS.** Sitework costs are tabulated in Table A-57 as multiples of a baseline barrier. The baseline barrier is either an 8-foot chain link fence (7-foot fabric with outrigger) or an 8-foot high, 12-foot wide (one traffic lane) motorized chain link gate. The costs of those two barriers are easily located in commercial cost estimating guides or in military construction cost databases. The cost multipliers for other barriers were determined by comparing the costs of those barriers to the costs of the baseline barriers. The barriers in Table A-57 are identified by threat severity level for perimeter and active barriers. The barriers associated with those threat severity levels are identified in Appendix C. Boat barrier costs are not included because the costs vary widely and the design guidance is still being developed.

Table A-1. Guide to Cost Tables

Tactic		Threat Severity Level	Explosive Weight or other Information	Level of Protection	Table	Page
Vehicle Bombs	VL	25 kg (55 lbs)	VL	A-2	A-6	
			L	A-2	A-6	
			M	A-3	A-7	
			H	A-4	A-8	
	L	100 kg (220 lbs)	VL	A-5	A-9	
			L	A-6	A-10	
			M	A-7	A-11	
			H	A-8	A-12	
	M	250 kg (550 lbs)	VL	A-9	A-14	
			L	A-10	A-15	
			M	A-11	A-16	
			H	A-12	A-18	
	H	500 kg (1100 lbs)	VL	A-13	A-20	
			L	A-14	A-21	
			M	A-15	A-22	
			H	A-16	A-24	
	VH	2000 kg (4400 lbs)	VL	A-17	A-26	
			L	A-18	A-27	
			M	A-19	A-29	
			H	A-20	A-31	
	Special Case	9000 kg (19,800 lbs)	VL	A-21	A-33	
			L	A-22	A-34	
			M	A-23	A-36	
			H	A-24	A-38	
Hand Delivered Devices	Exterior	L	IID Only	All	A-25	A-40
		M	1 kg (2.2 lbs)	All	A-26	A-40
		H	25 kg (55 lbs)	VL	A-2	A-6
				L	A-2	A-6
				M	A-3	A-7
				H	A-4	A-8
	All Interior Spaces	L	IID Only	No cost increase ¹		
	Mail rooms	M & H	1 kg (2.2 lbs)	All	A-27	A-41
	Loading Docks	M	1 kg (2.2 lbs)	All	A-28	A-42
		H	25 kg (55 lbs)	All	A-29	A-43
	Entry Areas	M	1 kg (2.2 lbs)	All	A-30	A-44
		H	25 kg (55 lbs)	All	A-31	A-45

Table A-1 (continued)

Tactic		Threat Severity Level	Explosive Weight or other Information	Level of Protection	Table	Page
Indirect Fire Weapons		L	IID	All	A-32	A-46
		M	82 mm Mortar	All	A-33	A-47
		H	Rocket	All	A-34	A-48
		VH	Imp. Mortar	All	A-35	A-49
Direct Fire Weapons		L	UL Level 3	All	A-36	A-50
		M	UL Level 5	All	A-37	A-51
		H	UL Level 8	All	A-38	A-52
		VH	Antitank weapon & 0.50 caliber	All	A-39	A-53
Airborne Contamination		All	Chemical, biological, and radiological agents	All	A-40	A-54
Waterborne Contamination		All	Chemical, biological, and radiological agents	All	A-41	A-54
Waterfront Attack	Surface or Submerged Attack	L	100 kg (surf) explosives	All ²	A-5 to A-8	A-9 to A-13
			25 kg (sub) explosives		A-2 to A-4	A-6 to A-8
			UL Level 5		A-37	A-51
		M	250 kg (surf) explosives	All ²	A-9 to A-12	A-14 to A-19
			25 kg (sub) explosives		A-2 to A-4	A-6 to A-8
			UL Level 10		A-39	A-53
H	500 kg explosives (surf & sub)	All ²	A-13 to A-16	A-20 to A-25		
	AT weapons & UL Lev 10		A-39	A-53		

Table A-1 (continued)

Forced Entry	Exterior ⁴	L	Various Forced Entry Tools	All	A-42	A-55
		M		All	A-43	A-56
		H		All	A-44	A-57
		VH		All	A-45	A-58
	Interior ⁴	L	Various Forced Entry Tools	All	A-46	A-59
		M		All	A-47	A-61
		H		All	A-48	A-63
		VH		All	A-48 ³	A-63
Covert Entry		L	None	All	A-49	A-65
		M		All	A-50	A-65
		H		All	A-51	A-66
		VH		All	A-52	A-66
Visual Surveillance		H	Ocular devices	H	A-53	A-67
Acoustics Eavesdropping	Exterior ⁴	H	Sound amplification or laser "listening" devises	All	A-54	A-68
	Interior ⁴				A-55	A-69
Electronic Emanations Eavesdropping	Exterior ⁴	H	Electronic emanations interception equipment	All	A-56	A-70
	Interior ⁴					
Sitework Costs		All	None	All	A-57	A-71

Notes:

1. No cost increases over conventional construction because interior construction commonly fire resistant and it is assumed there are no windows.
2. Apply applicable table based on level of protection
3. Do not use very high threat severity level for interior case because it includes explosives, which are considered unlikely due to collateral damage. Apply cost for High threat severity level.
4. Use the exterior tables where entire buildings or large portions of them are to be protected. In the latter case, use percentages of the costs shown in the table based on the percentage of building perimeter area that will be protected. Use interior tables where protection will be focused on interior rooms within buildings. Combinations of interior and exterior costs can also be used where applicable.

Table A-2. 25 kg- TNT Very Low and Low Level of Protection

STANDOFF DISTANCE (meters)	% Increase				Construction Type				STANDOFF DISTANCE (meters)	%Δ	Construction Type				STANDOFF DISTANCE (meters)	%Δ	Construction Type			
	ADMIN FACILITY	MEDICAL CLINIC	BARRACKS (EXT ENT)	BARRACKS (INT ENT)	Walls	Windows	Doors	Roofs			DINING FACILITY	Walls	Windows	Doors			Roofs	SPECIAL STRUCTURE	Walls	Windows
Very Low LOP																				
≥10	9.5	1.7	1.7	1.7	-	A	-	-	≥10	1.2	-	A	-	-	≥10	1.7	-	A	-	-
Low LOP																				
10.0- 13.3	16.8	7.0	7.5	3.2	B	B	B	6	10.0-10.8	6.8	B	B	B	31	10.0-10.2	6.5	C	B	B	50
13.4-14.4	16.3	6.3	7.2	2.9	B	B	B	5	10.9-12.1	5.6	B	B	B	30	10.3-14.5	6.3	B	B	B	50
14.5	16.0	6.1	7.2	2.7	A	B	B	5	12.2-13.2	5.0	B	B	B	26	14.6-16.4	6.2	B	A	B	50
14.6-15.7	15.5	6.0	7.0	2.6	A	A	B	5	13.3-14.4	5.0	B	B	B	25	16.5-20.9	6.0	A	A	B	50
15.8-16.0	15.4	5.8	6.9	2.5	A	A	B	5	14.5	4.7	A	B	B	25	21.0-24.9	5.0	A	A	A	50
16.1-20.9	15.3	5.6	6.8	2.4	A	A	B	3	14.6-20.9	4.7	A	A	B	25	25.0-	1.7	-	A	-	-
21.0-24.9	14.5	4.5	6.7	2.1	A	A	A	1	21.0-24.9	3.9	A	A	A	25						
25.0-	9.5	1.7	1.7	1.7	-	A	-	-	25.0-	1.2	-	A	-	-						

A-6

Table A-3. 25 kg- TNT Medium Level of Protection

STANDOFF DISTANCE IN METERS	% Increase				Construction Type				STANDOFF DISTANCE IN METERS	%Δ	Construction Type				STANDOFF DISTANCE IN METERS	%Δ	Construction Type			
	ADMIN FACILITY	MEDICAL CLINIC	BARRACKS (EXT ENT)	BARRACKS (INT ENT)	Walls	Windows	Doors	Roofs			DINING FACILITY	Walls	Windows	Doors			Roofs	SPECIAL STRUCTURE	Walls	Windows
10.0 - 10.4	28.5	20.7	63.1	9.2	L	B	B	7	10.0 - 10.4	16.7	L	B	H	31	10.0 - 10.3	21.9	L	B	H	58
10.5 - 10.7	27.5	20.2	62.5	8.5	E	B	B	7	10.5 - 10.7	16.1	E	B	H	31	10.4 - 10.7	19.7	L	B	H	54
10.8 - 12.4	26.2	18.6	55.1	7.9	E	B	B	7	10.8 - 12.4	14.9	E	B	G	31	10.8 - 12.4	18.0	L	B	G	54
12.5 - 12.9	25.9	18.4	54.8	7.7	C	B	B	7	12.5 - 14.5	14.6	C	B	G	31	12.5	17.3	L	B	G	51
13.0 - 14.5	25.2	17.4	54.4	7.2	C	B	B	6	14.6 - 15.6	14.5	C	A	G	31	12.6 - 13.4	16.9	E	B	G	51
14.6 - 15.6	24.8	17.3	54.3	7.2	C	A	A	6	15.7 - 15.8	12.2	C	A	F	31	13.5 - 14.4	16.9	E	B	G	50
15.7 - 17.0	22.3	14.1	39.5	6.0	C	A	A	6	15.9 - 17.0	11.0	C	A	F	30	14.5	16.7	C	B	G	50
17.1 - 17.3	21.7	13.8	39.1	5.6	B	A	A	6	17.1 - 17.3	10.7	B	A	F	30	14.6 - 15.6	16.6	C	A	G	50
17.4 - 18.7	21.1	13.0	35.4	5.3	B	A	A	6	17.4 - 17.8	10.1	B	A	E	30	15.7 - 17.3	13.4	C	A	F	50
18.8 - 20.9	20.6	12.3	35.1	5.1	B	A	A	5	17.8 - 18.9	9.5	B	A	E	26	17.4 - 20.4	12.6	C	A	E	50
21.0 - 21.7	15.1	5.2	2.5	2.5	B	A	A	5	19.0 - 20.9	9.4	B	A	E	25	20.5 - 20.9	12.3	B	A	E	50
21.8 - 22.6	15.0	5.0	2.4	2.4	B	A	A	3	21.0 - 27.1	4.2	B	A	A	25	21.0 - 31.5	5.2	B	A	A	50
22.7 - 27.1	14.8	4.7	2.3	2.3	B	A	A	1	27.2 -	3.9	A	A	A	25	31.6 -	5.0	A	A	A	50
27.2 -	14.5	4.5	2.0	2.1	A	A	A	1												

Table A-4. 25 kg- TNT High Level of Protection

STANDOFF DISTANCE IN METERS	% Increase				Construction Type				STANDOFF DISTANCE IN METERS	%Δ	Construction Type				STANDOFF DISTANCE IN METERS	%Δ	Construction Type			
	ADMIN FACILITY	MEDICAL CLINIC	BARRACKS (EXT ENT)	BARRACKS (INT ENT)	Walls	Windows	Doors	Roofs			DINING FACILITY	Walls	Windows	Doors			Roofs	SPECIAL STRUCTURE	Walls	Windows
10.0-11.9	52.2	26.0	69.2	15.1	T	G	H	7	10.0-11.9	22.5	T	G	H	31	10.0-12.1	27.2	T	G	H	58
12.0-12.3	49.6	24.8	67.4	13.4	Q	G	H	7	12.0-12.3	20.8	Q	G	H	31	12.2-12.3	26.0	Q	G	H	58
12.4-13.1	48.4	23.2	60.0	12.9	Q	G	G	7	12.4-13.1	19.6	Q	G	G	31	12.4-13.7	24.4	Q	G	G	58
13.2-14.6	47.7	22.8	59.6	12.4	P	G	G	7	13.2-14.6	19.2	P	G	G	31	13.8-14.9	24.1	P	G	G	58
14.7-16.7	47.4	22.7	59.4	12.2	O	G	G	7	14.7-16.7	18.9	O	G	G	31	15.0-16.7	23.9	O	G	G	58
16.8-17.8	33.9	20.4	57.1	9.9	O	F	G	7	16.8-17.8	16.8	O	F	G	31	16.8-17.8	21.6	O	F	G	58
17.9-19.8	31.4	17.2	42.3	8.8	O	F	F	7	17.9-19.8	14.5	O	F	F	31	17.9-19.8	18.4	O	F	F	58
19.9-20.9	30.8	16.3	38.6	8.5	O	F	E	7	19.9-20.9	13.9	O	F	E	31	19.9-21.7	17.6	O	F	E	58
21.0-22.5	30.3	16.1	38.3	8.2	L	F	E	7	21.0-22.5	13.5	L	F	E	31	21.8-22.4	17.3	L	F	E	58
22.6-23.1	28.7	15.8	38.0	7.9	L	E	E	7	22.6-23.1	13.3	L	E	E	31	22.5-22.5	15.1	L	F	E	54
23.2-24.8	26.7	15.5	37.7	7.6	L	D	E	7	23.2-24.8	13.0	L	D	E	31	22.6-23.1	14.8	L	E	E	54
24.9-26.0	26.3	15.0	35.6	7.4	L	D	D	7	24.9-26.0	12.6	L	D	D	31	23.2-24.8	14.4	L	D	E	54
26.1-26.6	25.3	14.6	35.0	6.7	E	D	D	7	26.1-26.9	12.0	E	D	D	31	24.9-26.3	14.0	L	D	D	54
26.7-26.9	24.7	13.5	34.5	6.3	E	D	D	6	27.0-32.2	11.7	D	D	D	31	26.4-26.8	13.3	L	D	D	51
27.0-32.2	24.3	13.3	34.3	6.1	D	D	D	6	32.3-33.2	11.3	D	C	D	31	26.9-27.4	12.8	E	D	D	51
32.3-35.9	21.8	12.9	33.8	5.6	D	C	D	6	33.3-35.9	10.2	D	C	D	30	27.5-28.8	12.7	D	D	D	51
36.0-36.5	21.7	12.9	33.8	5.6	D	B	D	6	36.0-36.5	10.2	D	B	D	30	28.9-32.2	12.6	D	D	D	50
36.6-37.6	21.4	12.4	31.7	5.5	D	B	C	6	36.6-36.7	9.8	D	B	C	30	32.3-35.9	12.2	D	C	D	50
37.7-39.2	20.9	11.7	31.4	5.2	D	B	C	5	36.8-38.7	9.2	D	B	C	26	36.0-36.5	12.2	D	B	D	50
39.3-42.9	20.5	11.7	31.3	5.1	D	A	C	5	38.8-39.2	9.2	D	B	C	25	36.6-39.2	11.7	D	B	C	50
43.0-43.3	15.7	5.4	2.8	2.9	D	A	A	5	39.3-42.9	9.1	D	A	C	25	39.3-42.9	11.6	D	A	C	50
43.4-46.3	15.6	5.3	2.8	2.8	D	A	A	3	43.0-47.6	4.5	D	A	A	25	43.0-49.1	5.4	D	A	A	50
46.4-47.6	15.4	5.0	2.6	2.7	D	A	A	1	47.7-	4.2	B	A	A	25	49.2-	5.2	B	A	A	50
47.7-	14.8	4.7	2.3	2.3	B	A	A	1												

Table A-5. 100 kg- TNT Very Low Level of Protection

STANDOFF DISTANCE IN METERS	% Increase				Construction Type				STANDOFF DISTANCE IN METERS	%Δ	Construction Type				STANDOFF DISTANCE IN METERS	%Δ	Construction Type			
	ADMIN FACILITY	MEDICAL CLINIC	BARRACKS (EXT ENT)	BARRACKS (INT ENT)	Walls	Windows	Doors	Roofs			DINING FACILITY	Walls	Windows	Doors			Roofs	SPECIAL STRUCTURE	Walls	Windows
10.0-10.4	20.9	8.9	9.1	4.7	E	D	B	7	10.0-10.4	7.8	F	D	B	31	10.0-11.8	27.2	E	D	B	58
10.5-14.1	20.6	8.7	8.8	4.5	C	D	B	7	10.5-14.1	7.6	C	D	B	31	11.9-15.3	26.0	C	D	B	58
14.2-19.4	20.0	8.5	8.4	4.1	B	D	B	7	14.2-19.4	7.2	B	D	B	31	15.4-16.1	24.4	C	D	B	54
19.5-20.2	17.5	8.0	8.0	3.7	B	C	B	7	19.5-20.3	6.8	B	C	B	31	16.2-18.6	24.1	B	D	B	54
20.3-20.3	16.8	7.0	7.5	3.2	B	C	B	6	20.4-22.9	6.8	B	B	B	31	18.7-19.4	23.9	C	D	B	51
20.4-23.0	16.8	7.0	7.5	3.2	B	B	B	6	23.0-23.0	5.6	B	B	B	30	19.5-19.5	21.6	C	C	B	51
23.1-27.9	16.4	6.8	7.3	3.0	A	B	B	6	23.1-25.7	5.4	A	B	B	30	19.6-20.3	18.4	C	C	B	50
28.0-28.6	16.0	6.7	7.2	2.9	A	A	B	6	25.8-27.9	4.8	A	B	B	26	20.4-26.2	17.6	C	B	B	50
28.7-33.4	15.5	6.0	6.9	2.6	A	A	B	5	28.0-28.4	4.7	A	A	B	26	26.3-38.9	17.3	A	A	B	50
33.5-33.6	15.4	5.8	6.8	2.5	A	A	B	3	28.5-38.9	4.7	A	A	B	25	39.0-	15.1	A	A	A	50
33.7-38.9	15.3	5.6	6.7	2.4	A	A	B	1	39.0-44.9	3.9	A	A	A	25						
39.0-	14.5	4.5	2.0	2.1	A	A	A	1	45 -	1.2										

Table A-6. 100 kg- TNT Low Level of Protection

STANDOFF DISTANCE IN METERS	% Increase				Construction Type				STANDOFF DISTANCE IN METERS	%Δ	Construction Type				STANDOFF DISTANCE IN METERS	%Δ	Construction Type			
	ADMIN FACILITY	MEDICAL CLINIC	BARRACKS (EXT ENT)	BARRACKS (INT ENT)	Walls	Windows	Doors	Roofs			DINING FACILITY	Walls	Windows	Doors			Roofs	SPECIAL STRUCTURE	Walls	Windows
10.0	24.8	10.1	10.6	6.2	P	E	B	7	10.0	9.3	P	E	B	31	10.0	11.3	P	E	B	58
10.1	22.7	9.8	10.2	5.9	P	D	B	7	10.1	9.0	P	D	B	31	10.1-11.7	11.0	P	D	B	58
10.2	22.4	9.6	10.0	5.7	O	D	B	7	10.2	8.8	O	D	B	31	11.8-15.1	10.6	L	D	B	58
10.3-13.2	21.9	9.4	9.7	5.4	L	D	B	7	10.3-13.2	8.5	L	D	B	31	15.2-18.8	10.1	E	D	B	58
13.3-16.5	20.9	8.9	9.1	4.7	E	D	B	7	13.3-16.5	7.8	E	D	B	31	18.9-19.0	9.9	C	D	B	58
16.6-20.3	20.6	8.7	8.8	4.5	C	D	B	7	16.6-20.3	7.6	C	D	B	31	19.1-20.3	7.7	C	D	B	54
20.4-20.9	18.0	8.3	8.4	4.0	C	C	B	7	20.4-20.9	7.2	C	C	B	31	20.4-20.9	7.2	C	C	B	54
21.0-21.5	18.0	8.3	8.4	4.0	C	B	B	7	21.0-21.5	7.2	C	B	B	31	21.0-23.2	7.2	C	B	B	54
21.6-24.2	17.4	8.0	8.0	3.7	B	B	B	7	21.6-28.6	6.8	B	B	B	31	23.3-24.5	6.5	C	B	B	51
24.3-29.2	16.8	7.0	7.5	3.2	B	B	B	6	28.7-29.2	5.6	B	B	B	30	24.6-24.8	6.5	C	B	B	50
29.3-34.4	16.3	6.9	7.5	3.1	B	A	B	6	29.3-31.9	5.6	B	A	B	30	24.9-29.2	6.3	B	B	B	50
34.5-35.5	15.9	6.2	7.2	2.9	B	A	B	5	32.0-34.6	5.0	B	A	B	26	29.3-40.7	6.2	B	A	B	50
35.6-39.8	15.5	6.0	6.9	2.6	A	A	B	5	34.7-35.5	4.9	B	A	B	25	40.8-48.9	6.0	A	A	B	50
39.9-40.4	15.4	5.8	6.8	2.5	A	A	B	3	35.6-48.9	4.7	A	A	B	25	49.0-	5.0	A	A	A	50
40.5-48.9	15.3	5.6	6.7	2.4	A	A	B	1	49.0-	3.9	A	A	A	25						
49.0-	14.5	4.5	2.0	2.1	A	A	A	1												

Table A-7. 100 kg- TNT Medium Level of Protection

STANDOFF DISTANCE IN METERS	% Increase				Construction Type				STANDOFF DISTANCE IN METERS	%Δ	Construction Type				STANDOFF DISTANCE IN METERS	%Δ	Construction Type			
	ADMIN FACILITY	MEDICAL CLINIC	BARRACKS (EXT ENT)	BARRACKS (INT ENT)	Walls	Windows	Doors	Roofs			DINING FACILITY	Walls	Windows	Doors			Roofs	SPECIAL STRUCTURE	Walls	Windows
10.0-	37.8	24.8	74.0	12.8	S	E	I	7	10.0	21.0	S	E	I	31	10.0	26.0	S	E	I	58
10.1-10.9	35.8	24.5	73.6	12.5	S	D	I	7	10.1-10.9	20.7	S	D	I	31	10.1-11.3	25.7	S	D	I	58
11.0-11.8	35.4	24.3	73.4	12.2	R	D	I	7	11.0-11.8	20.4	R	D	I	31	11.3-12.4	25.5	R	D	I	58
11.9-12.8	33.2	23.2	71.9	10.7	P	D	I	7	11.9-12.8	18.9	P	D	I	31	12.4-12.9	24.4	P	D	I	58
12.9-15.5	31.8	21.5	64.1	10.1	P	D	H	7	12.9-15.5	17.7	P	D	H	31	12.9-16.1	22.7	P	D	H	58
15.6-17.1	31.5	21.3	63.8	9.9	N	D	H	7	15.6-17.1	17.4	N	D	H	31	16.1-17.2	22.6	N	D	H	58
17.2-18.6	30.2	19.7	56.5	9.3	N	D	G	7	17.2-18.6	16.2	N	D	G	31	17.2-20.0	20.9	N	D	G	58
18.7-20.3	29.8	19.5	56.2	9.0	L	D	G	7	18.7-20.3	15.9	L	D	G	31	20.0-20.4	20.8	M	D	G	58
20.4-20.9	27.3	19.1	55.7	8.6	L	C	G	7	20.4-20.9	15.5	L	C	G	31	20.4-21.0	20.4	M	C	G	58
21.0-24.6	27.2	19.1	55.7	8.6	L	B	G	7	21.0-24.6	15.5	L	B	G	31	21.0-22.5	20.4	M	B	G	58
24.7-24.9	26.2	18.6	55.1	7.9	E	B	G	7	24.7	14.9	E	B	G	31	22.5-25.0	20.3	L	B	G	58
25.0-27.6	23.7	15.4	40.3	6.8	E	B	F	7	25.0-27.6	12.5	E	B	F	31	25.0-27.6	17.1	L	B	F	58
27.7-29.2	23.1	14.6	36.6	6.5	E	B	E	7	27.7-29.2	11.9	E	B	E	31	27.6-27.7	14.8	L	B	F	54
29.3-29.8	22.7	14.5	36.5	6.4	E	A	E	7	29.3-29.8	11.8	E	A	E	31	27.7-29.3	14.0	L	B	E	54
29.9-33.0	22.3	14.3	36.3	6.2	C	A	E	7	29.9-34.5	11.6	C	A	E	31	29.3-30.1	13.9	L	A	E	54
33.1-34.5	21.6	13.3	35.8	5.7	C	A	E	6	34.6-40.3	11.2	C	A	D	31	30.1-33.0	13.5	E	A	E	54
34.6-40.8	21.3	12.8	33.7	5.6	C	A	D	6	40.4-40.8	10.1	C	A	D	30	33.0-34.6	12.8	E	A	E	51
40.9-46.3	20.7	12.5	33.4	5.2	B	A	D	6	40.9-44.7	9.7	B	A	D	30	34.6-35.2	12.3	E	A	D	51
46.4-48.9	20.3	11.9	33.1	4.9	B	A	D	5	44.8-47.7	9.1	B	A	D	26	35.2-35.4	12.1	C	A	D	51
49.0-53.5	15.1	5.2	2.5	2.5	B	A	A	5	47.8-48.9	9.1	B	A	D	25	35.4-49.0	12.1	C	A	D	50
53.6-56.0	15.0	5.0	2.4	2.4	B	A	A	3	49.0-66.4	4.2	B	A	A	25	49.0-49.6	5.4	C	A	A	50
56.1-66.4	14.8	4.7	2.3	2.3	B	A	A	1	66.5-	3.9	A	A	A	25	49.6-78.4	5.2	B	A	A	50
66.5-	14.5	4.5	2.0	2.1	A	A	A	1						78.4-	5.0	A	A	A	50	

A-11

Table A-8. 100 kg- TNT High Level of Protection

STANDOFF DISTANCE IN METERS	% Increase				Construction Type				STANDOFF DISTANCE IN METERS	%Δ	Construction Type				STANDOFF DISTANCE IN METERS	%Δ	Construction Type			
	ADMIN FACILITY	MEDICAL CLINIC	BARRACKS (EXT ENT)	BARRACKS (INT ENT)	Walls	Windows	Doors	Roofs			DINING FACILITY	Walls	Windows	Doors			Roofs	SPECIAL STRUCTURE	Walls	Windows
12.0-12.4	57.4	29.7	78.7	17.5	W	H	I	12	12.0-12.5	29.6	W	H	I	45	12.7-12.8	30.2	W	G	I	60
12.5-14.6	55.8	29.4	78.5	17.2	W	G	I	12	12.5-13.5	29.3	W	G	I	45	12.9-14.0	29.9	W	G	I	59
14.7-17.1	54.5	27.7	70.7	16.6	W	G	H	12	13.5-14.7	25.5	W	G	I	36	14.1-14.6	29.7	W	G	I	58
17.2-17.5	53.9	26.8	70.3	16.2	W	G	H	7	14.7-17.6	24.2	W	G	H	36	14.7-18.9	28.0	W	G	H	58
17.6-19.6	52.2	26.0	69.2	15.1	T	G	H	7	17.6-17.8	23.1	T	G	H	36	19.0-19.6	27.2	T	G	H	58
19.7-26.6	51.0	24.4	61.8	14.6	T	G	G	7	17.8-19.7	23.0	T	G	H	35	19.7-28.5	25.6	T	G	G	58
26.7-28.2	48.4	23.2	60.0	12.9	Q	G	G	7	19.7-20.2	21.8	T	G	G	35	28.6-28.6	22.4	T	G	F	58
28.3-28.5	47.7	22.8	59.6	12.4	P	G	G	7	20.2-21.6	21.7	T	G	G	34	28.7-28.7	20.1	T	F	F	58
28.6-28.6	45.2	19.6	44.8	11.3	P	G	F	7	21.6-26.7	21.3	T	G	G	31	28.8-30.7	18.8	Q	F	F	58
28.7-31.5	31.8	17.3	42.5	9.0	P	F	F	7	26.7-28.3	19.6	Q	G	G	31	30.8-31.5	18.5	P	F	F	58
31.6-33.2	31.1	16.5	38.9	8.7	P	F	E	7	28.3-28.6	19.2	P	G	G	31	31.6-35.5	17.7	P	F	E	58
33.3-38.3	30.8	16.3	38.6	8.5	O	F	E	7	28.6-28.7	16.8	P	G	F	31	35.6-38.3	17.6	O	F	E	58
38.4-39.4	29.2	16.1	38.4	8.2	O	E	E	7	28.7-31.6	14.7	P	F	F	31	38.4-39.5	17.3	O	E	E	58
39.5-39.5	28.8	15.6	36.3	8.1	O	E	D	7	31.6-33.3	14.1	P	F	E	31	39.6-39.4	16.9	O	D	E	58
39.6-45.7	26.8	15.3	35.9	7.7	O	D	D	7	33.3-38.4	13.9	O	F	E	31	39.5-51.4	16.5	O	D	D	58
45.8-56.9	26.3	15.0	35.6	7.4	L	D	D	7	38.4-39.5	13.6	O	E	E	31	51.5-56.6	16.3	L	D	D	58
57.0-58.2	23.8	14.6	35.2	7.0	L	C	D	7	39.5-39.6	13.3	O	E	D	31	56.7-56.9	14.0	L	D	D	54
58.3-62.2	22.4	13.7	32.4	6.1	E	C	C	7	39.6-45.8	13.0	O	D	D	31	57.0-58.2	13.6	L	C	D	54
62.3-63.9	22.1	13.5	32.1	5.9	D	C	C	7	45.8-57.0	12.6	L	D	D	31	58.3-64.3	13.1	L	C	C	54
64.0-64.8	21.4	12.4	31.7	5.5	D	C	C	6	57.0-58.3	12.2	L	C	D	31	64.4-64.8	12.6	E	C	C	54
64.9-74.6	21.4	12.4	31.7	5.5	D	B	C	6	58.3-62.3	11.2	E	C	C	31	64.9-66.4	12.6	E	B	C	54
74.7-90.1	20.9	12.3	31.6	5.4	D	A	C	6	62.3-64.9	11.0	D	C	C	31	66.5-66.9	12.4	D	B	C	54
90.2-97.9	20.5	11.7	31.3	5.1	D	A	C	5	64.9-74.7	11.0	D	B	C	31	67.0-72.6	11.7	D	B	C	54
98.0-104.4	15.7	5.4	2.8	2.9	D	A	A	5	74.7-82.6	10.9	D	A	C	31	72.7-74.6	11.7	D	B	C	54

A-12

Table A-8 (continued). 100 kg- TNT High Level of Protection

STANDOFF DISTANCE IN METERS	% Increase				Construction Type				STANDOFF DISTANCE IN METERS	%Δ	Construction Type				STANDOFF DISTANCE IN METERS	%Δ	Construction Type			
	ADMIN FACILITY	MEDICAL CLINIC	BARRACKS (EXT ENT)	BARRACKS (INT ENT)	Walls	Windows	Doors	Roofs			DINING FACILITY	Walls	Windows	Doors			Roofs	SPECIAL STRUCTURE	Walls	Windows
104.5-108.4	15.6	5.3	2.8	2.8	D	A	A	3	82.6-91.2	9.8	D	A	C	30	74.7-97.9	11.6	D	A	C	50
108.5-111.9	15.0	5.0	2.4	2.4	B	A	A	3	91.2-96.1	9.2	D	A	C	26	98.0-118.4	5.4	D	A	A	50
112.0-	14.8	4.7	2.3	2.3	B	A	A	1	96.1-98.0	9.1	D	A	C	25	118.5-	5.2	B	A	A	50
									98.0-108.5	4.5	D	A	A	25						
									108.5-	4.2	B	A	A	25						

Table A-9. 250 kg- TNT Very Low Level of Protection

STANDOFF DISTANCE IN METERS	% Increase				Construction Type				STANDOFF DISTANCE IN METERS	%Δ	Construction Type				STANDOFF DISTANCE IN METERS	%Δ	Construction Type			
	ADMIN FACILITY	MEDICAL CLINIC	BARRACKS (EXT ENT)	BARRACKS (INT ENT)	Walls	Windows	Doors	Roofs			DINING FACILITY	Walls	Windows	Doors			Roofs	SPECIAL STRUCTURE	Walls	Windows
10.0-10.3	61.3	16.6	17.1	12.7	Q	J	B	7	10.0-10.2	15.7	Q	J	B	34	10.0-10.3	17.8	Q	J	B	58
10.4-10.9	51.3	14.8	15.4	11.0	Q	I	B	7	10.3	15.4	Q	J	B	31	10.4-10.9	16.1	Q	I	B	58
11.0-11.2	27.0	10.7	11.3	6.9	Q	F	B	7	10.4-10.9	13.8	Q	I	B	31	11.0-12.7	11.9	Q	F	B	58
11.3-11.5	26.1	10.2	10.6	6.3	O	F	B	7	11.0-11.2	10.0	Q	F	B	31	12.8-12.9	11.4	O	F	B	58
11.6-14.8	25.6	10.0	10.3	6.0	L	F	B	7	11.3-11.5	9.4	O	F	B	31	13.0-14.8	11.2	L	F	B	58
14.9-15.0	24.0	9.7	10.1	5.7	L	E	B	7	11.6-14.8	9.0	L	F	B	31	14.9-16.9	10.9	L	E	B	58
15.1-17.0	23.0	9.3	9.4	5.0	E	E	B	7	14.9-15.0	8.8	L	E	B	31	17.0-17.0	10.5	E	E	B	58
17.1-18.7	20.9	8.9	9.1	4.7	E	D	B	7	15.1-17.0	8.1	E	E	B	31	17.1-21.2	10.1	E	D	B	58
18.8-25.2	20.6	8.7	8.8	4.5	C	D	B	7	17.1-18.7	7.8	E	D	B	31	21.3-29.0	9.9	C	D	B	58
25.3-30.7	20.0	8.5	8.4	4.1	B	D	B	7	18.8-25.2	7.6	C	D	B	31	29.1-29.1	9.7	B	D	B	58
30.8-31.3	17.5	8.0	8.0	3.7	B	C	B	7	25.3-30.7	7.2	B	D	B	31	29.2-30.7	7.4	B	D	B	54
31.4-36.9	17.4	8.0	8.0	3.7	B	B	B	7	30.8-31.3	6.8	B	C	B	31	30.8-31.3	7.0	B	C	B	54
37.0-41.4	16.8	7.0	7.5	3.2	B	B	B	6	31.4-41.4	6.8	B	B	B	31	31.4-35.7	7.0	B	B	B	54
41.5-44.1	16.4	6.8	7.3	3.0	A	B	B	6	41.5-43.3	6.5	A	B	B	31	35.8-37.3	6.3	B	B	B	51
44.2-51.5	16.0	6.7	7.2	2.9	A	A	B	6	43.4-44.1	5.4	A	B	B	30	37.4-44.1	6.3	B	B	B	50
51.6-60.1	15.5	6.0	6.9	2.6	A	A	B	5	44.2-47.9	5.3	A	A	B	30	44.2-47.4	6.2	B	A	B	50
60.2-60.5	15.4	5.8	6.8	2.5	A	A	B	3	48.0-52.2	4.7	A	A	B	26	47.5-64.9	6.0	A	A	B	50
60.6-64.9	15.3	5.6	6.7	2.4	A	A	B	1	52.3-64.9	4.7	A	A	B	25	65.0-	5.0	A	A	A	50
65.0-	14.5	4.5	2.0	2.1	A	A	A	1	65.0-	3.9	A	A	A	25						

A-14

Table A-10. 250 kg- TNT Low Level of Protection

STANDOFF DISTANCE IN METERS	% Increase				Construction Type				STANDOFF DISTANCE IN METERS	%Δ	Construction Type				STANDOFF DISTANCE IN METERS	%Δ	Construction Type			
	ADMIN FACILITY	MEDICAL CLINIC	BARRACKS (EXT ENT)	BARRACKS (INT ENT)	Walls	Windows	Doors	Roofs			DINING FACILITY	Walls	Windows	Doors			Roofs	SPECIAL STRUCTURE	Walls	Windows
10.0-10.6	64.5	18.7	19.2	14.8	T	J	B	12	10.0-10.4	17.7	T	J	B	36	10.0-10.6	19.0	T	J	B	58
10.7-11.3	54.5	17.0	17.5	13.1	T	I	B	12	10.5-10.6	17.6	T	J	B	35	10.7-11.5	17.3	T	I	B	58
11.4-11.5	53.9	16.1	17.1	12.7	T	I	B	7	10.7-11.5	16.0	T	I	B	35	11.6-12.0	13.1	T	F	B	58
11.6-11.7	29.6	11.9	13.0	8.6	T	F	B	7	11.6-11.7	12.2	T	F	B	35	12.1-14.9	12.9	S	F	B	58
11.8-14.5	29.0	11.6	12.6	8.2	S	F	B	7	11.8-12.0	11.8	S	F	B	35	15.0-15.4	12.7	R	F	B	58
14.6-15.3	28.6	11.4	12.4	8.0	R	F	B	7	12.1-12.6	11.7	S	F	B	34	15.5-15.8	12.4	R	E	B	58
15.4-15.4	26.4	10.4	10.9	6.5	P	F	B	7	12.7-14.5	11.3	S	F	B	31	15.9-17.9	11.3	P	E	B	58
15.5-17.9	24.8	10.1	10.6	6.2	P	E	B	7	14.6-15.3	11.1	R	F	B	31	18.0-20.7	11.0	P	D	B	58
18.0-18.0	22.7	9.8	10.2	5.9	P	D	B	7	15.4-15.4	9.6	P	F	B	31	20.8-27.0	10.6	L	D	B	58
18.1-23.3	21.9	9.4	9.7	5.4	L	D	B	7	15.5-17.9	9.3	P	E	B	31	27.1-31.0	10.1	E	D	B	58
23.4-29.2	20.9	8.9	9.1	4.7	E	D	B	7	18.0-18.0	9.0	P	D	B	31	31.1-31.3	9.7	E	C	B	58
29.3-31.0	20.6	8.7	8.8	4.5	C	D	B	7	18.1-23.3	8.5	L	D	B	31	31.4-33.9	9.7	E	B	B	58
31.1-31.3	18.0	8.3	8.4	4.0	C	C	B	7	23.4-29.2	7.8	E	D	B	31	34.0-36.2	9.5	C	B	B	58
31.4-38.4	18.0	8.3	8.4	4.0	C	B	B	7	29.3-31.0	7.6	C	D	B	31	36.3-43.8	7.2	C	B	B	54
38.5-44.0	17.4	8.0	8.0	3.7	B	B	B	7	31.1-31.3	7.2	C	C	B	31	43.9-44.1	6.5	C	B	B	51
44.1-44.1	17.0	7.9	7.9	3.6	B	A	B	7	31.4-38.4	7.2	C	B	B	31	44.2-44.7	6.5	C	A	B	51
44.2-64.1	17.0	7.9	7.9	3.6	B	A	B	7	38.5-44.1	6.8	B	B	B	31	44.8-46.1	6.2	B	A	B	51
64.2-61.0	16.6	7.8	7.7	3.3	A	A	B	7	44.2-52.3	6.7	B	A	B	31	46.2-74.3	6.2	B	A	B	50
61.1-71.5	15.5	6.0	6.9	2.6	A	A	B	5	52.4-57.7	5.6	B	A	B	30	74.4-83.9	6.0	A	A	B	50
71.6-72.8	15.4	5.8	6.8	2.5	A	A	B	3	57.8-63.3	5.0	B	A	B	26	84.0-	5.0	A	A	A	50
72.9-83.9	15.3	5.6	6.7	2.4	A	A	B	1	63.4-64.1	4.9	B	A	B	25						
84.0-	14.5	4.5	2.0	2.1	A	A	A	1	64.2-83.9	4.7	A	A	B	25						
									84.0-	3.9	A	A	A	25						

A-15

Table A-11. 250 kg- TNT Medium Level of Protection

STANDOFF DISTANCE IN METERS	% Increase				Construction Type				STANDOFF DISTANCE IN METERS	%Δ	Construction Type				STANDOFF DISTANCE IN METERS	%Δ	Construction Type			
	ADMIN FACILITY	MEDICAL CLINIC	BARRACKS (EXT ENT)	BARRACKS (INT ENT)	Walls	Windows	Doors	Roofs			DINING FACILITY	Walls	Windows	Doors			Roofs	SPECIAL STRUCTURE	Walls	Windows
13.6-15.3	40.6	26.4	75.1	13.9	T	F	I	12	13.6-15.3	22.3	T	F	I	36	13.6-15.4	26.6	T	F	I	58
15.4-15.4	40.1	26.1	74.7	13.5	S	F	I	12	15.4-15.4	21.7	S	F	I	35	15.5-15.8	26.3	T	E	I	58
15.5-15.6	38.4	25.8	74.4	13.2	S	E	I	12	15.5-17.2	21.5	S	E	I	35	15.9-17.4	26.0	S	E	I	58
15.7-17.4	37.8	24.8	74.0	12.8	S	E	I	7	17.3-17.4	21.3	S	E	I	34	17.5-17.9	24.3	S	E	H	58
17.5-17.9	36.5	23.1	66.2	12.2	S	E	H	7	17.5-17.9	20.1	S	E	H	34	18.0-19.6	24.0	S	D	H	58
18.0-18.9	34.5	22.8	65.9	11.9	S	D	H	7	18.0-18.5	19.8	S	D	H	34	19.7-21.2	23.8	R	D	H	58
19.0-20.2	34.1	22.6	65.6	11.6	R	D	H	7	18.6-18.9	19.4	S	D	H	31	21.3-23.2	22.7	P	D	H	58
20.3-23.2	31.8	21.5	64.1	10.1	P	D	H	7	19.0-20.2	19.2	R	D	H	31	23.3-28.0	21.1	P	D	G	58
23.3-26.5	30.6	19.9	56.7	9.5	P	D	G	7	20.3-23.2	17.7	P	D	H	31	28.1-31.0	20.9	N	D	G	58
26.6-31.0	30.2	19.7	56.5	9.3	N	D	G	7	23.3-26.5	16.5	P	D	G	31	31.1-31.3	20.5	N	C	G	58
31.1-31.3	27.7	19.3	56.0	8.9	N	C	G	7	26.6-31.0	16.2	N	D	G	31	31.4-33.7	20.5	N	B	G	58
31.4-31.9	27.6	19.3	56.0	8.8	N	B	G	7	31.1-31.3	15.8	N	C	G	31	33.8-35.2	17.3	N	B	F	58
32.0-33.7	27.2	19.1	55.7	8.6	L	B	G	7	31.4-31.9	15.8	N	B	G	31	35.3-37.5	17.1	M	B	F	58
33.8-37.5	24.7	15.9	41.0	7.4	L	B	F	7	32.0-33.7	15.5	L	B	G	31	37.6-39.5	16.3	M	B	E	58
37.6-42.4	24.1	15.0	37.3	7.1	L	B	E	7	33.8-37.5	13.1	L	B	F	31	39.6-44.1	16.3	L	B	E	58
42.5-44.1	23.1	14.6	36.6	6.5	E	B	E	7	37.6-42.4	12.6	L	B	E	31	44.2-46.7	16.2	L	A	E	58
44.2-46.7	22.7	14.5	36.5	6.4	E	A	E	7	42.5-44.1	11.9	E	B	E	31	46.8-50.7	15.7	L	A	D	58
46.8-51.9	22.3	14.1	34.5	6.2	E	A	D	7	44.2-46.7	11.8	E	A	E	31	50.8-53.0	13.5	L	A	D	54
52.0-57.1	21.9	13.9	34.2	6.0	C	A	D	7	46.8-51.9	11.5	E	A	D	31	53.1-60.0	13.0	E	A	D	54
57.2-69.0	21.3	12.8	33.7	5.6	C	A	D	6	52.0-69.0	11.2	C	A	D	31	60.1-63.0	12.3	E	A	D	51
69.1-71.4	20.9	12.3	31.6	5.4	C	A	C	6	69.1-71.4	10.9	C	A	C	31	63.1-64.9	12.1	C	A	D	51
71.5-74.9	20.3	12.1	31.2	5.0	B	A	C	6	71.5-72.8	10.5	B	A	C	31	65.0-69.0	12.1	C	A	D	50
75.0-80.2	20.3	12.1	31.2	5.0	B	A	C	6	72.9-80.2	9.4	B	A	C	30	69.1-83.9	11.6	C	A	C	50
80.3-83.9	19.9	11.4	30.9	4.7	B	A	C	5	80.3-83.9	8.8	B	A	C	26	84.0-88.7	5.4	C	A	A	50

A-16

Table A-11 (continued). 250 kg- TNT Medium Level of Protection

STANDOFF DISTANCE IN METERS	% Increase				Construction Type				STANDOFF DISTANCE IN METERS	%Δ	Construction Type				STANDOFF DISTANCE IN METERS	%Δ	Construction Type			
	ADMIN FACILITY	MEDICAL CLINIC	BARRACKS (EXT ENT)	BARRACKS (INT ENT)	Walls	Windows	Doors	Roofs			DINING FACILITY	Walls	Windows	Doors			Roofs	SPECIAL STRUCTURE	Walls	Windows
84.0-94.0	15.1	5.2	2.5	2.5	B	A	A	5	84.0-85.6	4.2	B	A	A	26	88.8-141.9	5.2	B	A	A	50
94.1-98.6	15.0	5.0	2.4	2.4	B	A	A	3	85.7-117.9	4.2	B	A	A	25	142.0-	5.0	A	A	A	50
98.7-117.9	14.8	4.7	2.3	2.3	B	A	A	1	118.0-	3.9	A	A	A	25						
118.0-	14.5	4.5	2.0	2.1	A	A	A	1												

Table A-12. 250 kg- TNT High Level of Protection

STANDOFF DISTANCE IN METERS	% Increase				Construction Type				STANDOFF DISTANCE IN METERS	%Δ	Construction Type				STANDOFF DISTANCE IN METERS	%Δ	Construction Type			
	ADMIN FACILITY	MEDICAL CLINIC	BARRACKS (EXT ENT)	BARRACKS (INT ENT)	Walls	Windows	Doors	Roofs			DINING FACILITY	Walls	Windows	Doors			Roofs	SPECIAL STRUCTURE	Walls	Windows
18.1-19.8	62.0	37.2	82.0	20.6	W	H	I	24	18.1-19.8	30.9	W	H	I	48	19.7-19.8	37.2	W	H	I	72
19.9-19.9	57.4	29.7	78.7	17.5	W	H	I	12	19.9-19.9	29.6	W	H	I	45	19.9-19.9	30.5	W	H	I	60
20.0-20.9	56.1	28.0	70.9	16.9	W	H	H	12	20.0-20.9	28.3	W	H	H	45	20.0-20.9	28.8	W	H	H	60
21.0-26.6	54.5	27.7	70.7	16.6	W	G	H	12	21.0-26.0	28.1	W	G	H	45	21.0-25.0	28.5	W	G	H	60
26.7-26.8	53.2	26.1	63.3	16.1	W	G	G	12	26.1-26.6	24.2	W	G	H	36	25.1-26.6	28.2	W	G	H	59
26.9-32.8	51.6	25.3	62.2	15.0	T	G	G	12	26.7-26.8	23.0	W	G	G	36	26.7-27.0	26.5	W	G	G	59
32.9-38.5	51.0	24.4	61.8	14.6	T	G	G	7	26.9-34.1	21.9	T	G	G	36	27.1-29.7	26.4	W	G	G	58
38.6-39.8	48.4	21.1	47.0	13.4	T	G	F	7	34.2-38.5	21.8	T	G	G	35	29.8-38.5	25.6	T	G	G	58
39.9-42.4	35.0	18.8	44.7	11.1	T	F	F	7	38.6-38.7	19.4	T	G	F	35	38.6-39.8	22.4	T	G	F	58
42.5-42.8	34.4	18.6	44.3	10.7	S	F	F	7	38.8-39.8	19.3	T	G	F	34	39.9-42.8	20.1	T	F	F	58
42.9-42.9	33.7	17.7	40.6	10.4	S	F	E	7	39.9-41.3	17.2	T	F	F	34	42.9-48.8	19.3	T	F	E	58
43.0-44.2	31.8	16.8	39.3	9.1	Q	F	E	7	41.4-42.4	16.8	T	F	F	31	48.9-49.6	19.0	S	F	E	58
44.3-53.4	31.1	16.5	38.9	8.7	P	F	E	7	42.5-42.8	16.4	S	F	F	31	49.7-49.7	18.0	Q	F	E	58
53.5-53.8	30.8	16.0	36.8	8.5	P	F	D	7	42.9-42.9	15.8	S	F	E	31	49.8-53.4	17.7	P	F	E	58
53.9-54.5	29.2	15.8	36.5	8.3	P	E	D	7	43.0-44.2	14.5	Q	F	E	31	53.5-53.8	17.3	P	F	D	58
54.6-55.4	28.8	15.6	36.3	8.1	O	E	D	7	44.3-53.4	14.1	P	F	E	31	53.9-55.4	17.0	P	E	D	58
55.5-72.3	26.8	15.3	35.9	7.7	O	D	D	7	53.5-53.8	13.7	P	F	D	31	55.5-62.1	16.6	P	D	D	58
72.4-78.9	26.3	15.0	35.6	7.4	L	D	D	7	53.9-54.5	13.5	P	E	D	31	62.2-78.9	16.5	O	D	D	58
79.0-82.2	25.9	14.6	33.5	7.2	L	D	C	7	54.6-55.4	13.3	O	E	D	31	79.0-82.2	16.0	O	D	C	58
82.3-93.7	23.4	14.1	33.0	6.8	L	C	C	7	55.5-72.3	13.0	O	D	D	31	82.3-87.0	15.6	O	C	C	58
93.8-95.6	22.4	13.7	32.4	6.1	E	C	C	7	72.4-78.9	12.6	L	D	D	31	87.1-88.1	15.5	N	C	C	58
95.7-103.2	22.4	13.7	32.4	6.1	E	B	C	7	79.0-82.2	12.3	L	D	C	31	88.2-95.6	15.4	L	C	C	58
103.3-107.0	22.0	13.5	32.1	5.9	D	B	C	7	82.3-93.7	11.9	L	C	C	31	95.7-102.8	15.3	L	B	C	58
107.1-109.9	21.4	12.4	31.7	5.5	D	B	C	6	93.8-95.6	11.2	E	C	C	31	102.9-109.9	13.1	L	B	C	58

A-18

Table A-12 (continued). 250 kg- TNT High Level of Protection

STANDOFF DISTANCE IN METERS	% Increase				Construction Type				STANDOFF DISTANCE IN METERS	%Δ	Construction Type				STANDOFF DISTANCE IN METERS	%Δ	Construction Type			
	ADMIN FACILITY	MEDICAL CLINIC	BARRACKS (EXT ENT)	BARRACKS (INT ENT)	Walls	Windows	Doors	Roofs			DINING FACILITY	Walls	Windows	Doors			Roofs	SPECIAL STRUCTURE	Walls	Windows
110.0-150.3	20.9	12.3	31.6	5.4	D	A	C	6	95.7-103.2	11.2	E	B	C	31	110.0-111.7	13.0	L	A	C	54
150.4-164.9	20.5	11.7	31.3	5.1	D	A	C	5	103.3-109.9	11.0	D	B	C	31	111.8-117.3	12.5	E	A	C	54
165.0-175.9	16.1	6.1	3.1	3.1	D	A	A	6	110.0-145.3	10.9	D	A	C	31	117.4-121.4	12.4	D	A	C	54
176.0-176.3	15.6	5.3	2.8	2.8	D	A	A	3	145.4-159.3	9.8	D	A	C	30	121.5-131.8	11.7	D	A	C	51
176.4-189.5	15.0	5.0	2.4	2.4	B	A	A	3	159.4-164.9	9.2	D	A	C	26	131.9-164.9	11.6	D	A	C	50
189.6-	14.8	4.7	2.3	2.3	B	A	A	1	165.0-168.1	4.6	D	A	A	26	165.0-206.5	5.4	D	A	A	50
									168.2-176.3	4.5	D	A	A	25	206.6-	5.2	B	A	A	50
									176.4-	4.2	B	A	A	25						

Table A-13. 500 kg- TNT Very Low Level of Protection

STANDOFF DISTANCE IN METERS	% Increase				Construction Type				STANDOFF DISTANCE IN METERS	%Δ	Construction Type				STANDOFF DISTANCE IN METERS	%Δ	Construction Type			
	ADMIN FACILITY	MEDICAL CLINIC	BARRACKS (EXT ENT)	BARRACKS (INT ENT)	Walls	Windows	Doors	Roofs			DINING FACILITY	Walls	Windows	Doors			Roofs	SPECIAL STRUCTURE	Walls	Windows
13.3-15.1	61.9	17.5	17.5	13.1	Q	J	B	12	13.7-15.4	15.9	Q	J	B	35	13.7-15.0	19.0	T	J	B	58
15.2-15.4	61.3	16.6	17.1	12.7	Q	J	B	7	15.5-15.7	14.3	Q	I	B	35	15.1-15.4	17.8	Q	J	B	58
15.5-16.7	51.3	14.8	15.4	11.0	Q	I	B	7	15.8-16.5	14.2	Q	I	B	34	15.5-16.7	16.1	Q	I	B	58
16.8-17.2	27.0	10.7	11.3	6.9	Q	F	B	7	16.6-16.7	13.8	Q	I	B	31	16.8-19.6	11.9	Q	F	B	58
17.3-17.6	26.1	10.2	10.6	6.3	O	F	B	7	16.8-17.2	10.0	Q	F	B	31	19.7-20.1	11.4	O	F	B	58
17.7-21.8	25.6	10.0	10.3	6.0	L	F	B	7	17.3-17.6	9.4	O	F	B	31	20.2-21.8	11.2	L	F	B	58
21.9-23.2	24.0	9.7	10.1	5.7	L	E	B	7	17.7-21.8	9.0	L	F	B	31	21.9-25.5	10.9	L	E	B	58
23.3-25.5	23.0	9.3	9.4	5.0	E	E	B	7	21.9-23.2	8.8	L	E	B	31	25.6-26.4	10.6	L	D	B	58
25.6-28.7	20.9	8.9	9.1	4.7	E	D	B	7	23.3-25.5	8.1	E	E	B	31	26.5-32.9	10.1	E	D	B	58
28.8-39.2	20.6	8.7	8.8	4.5	C	D	B	7	25.6-28.7	7.8	E	D	B	31	33.0-41.4	9.9	C	D	B	58
39.3-41.4	20.0	8.5	8.4	4.1	B	D	B	7	28.8-39.2	7.6	C	D	B	31	41.5-41.7	9.5	C	C	B	58
41.5-41.7	17.5	8.0	8.0	3.7	B	C	B	7	39.3-41.4	7.2	B	D	B	31	41.8-45.3	9.5	C	B	B	58
41.8-56.6	17.4	8.0	8.0	3.7	B	B	B	7	41.5-41.7	6.8	B	C	B	31	41.8-45.3	9.5	C	B	B	58
56.7-59.3	16.8	7.0	7.5	3.2	B	B	B	6	41.8-59.3	6.8	B	B	B	31	45.4-47.4	9.2	B	B	B	58
59.4-64.4	16.3	6.9	7.5	3.1	B	A	B	6	59.4-64.4	6.7	B	A	B	31	47.5-57.3	7.0	B	B	B	54
64.5-78.4	16.0	6.7	7.2	2.9	A	A	B	6	64.5-67.2	6.5	A	A	B	31	57.4-59.3	6.3	B	B	B	51
78.5-92.1	15.5	6.0	6.9	2.6	A	A	B	5	67.3-74.1	5.3	A	A	B	30	59.4-59.7	6.2	B	A	B	51
92.2-92.9	15.4	5.8	6.8	2.5	A	A	B	3	74.2-81.9	4.7	A	A	B	26	59.8-74.7	6.2	B	A	B	50
93.0-	14.5	4.5	2.0	2.1	A	A	A	1	82.0-92.9	4.7	A	A	B	25	74.8-92.9	6.0	A	A	B	50
									93.0-	3.9	A	A	A	25	93.0-	5.0	A	A	A	50

Table A-14. 500 kg- TNT Low Level of Protection

STANDOFF DISTANCE IN METERS	% Increase				Construction Type				STANDOFF DISTANCE IN METERS	%Δ	Construction Type				STANDOFF DISTANCE IN METERS	%Δ	Construction Type			
	ADMIN FACILITY	MEDICAL CLINIC	BARRACKS (EXT ENT)	BARRACKS (INT ENT)	Walls	Windows	Doors	Roofs			DINING FACILITY	Walls	Windows	Doors			Roofs	SPECIAL STRUCTURE	Walls	Windows
13.5-15.5	64.5	18.7	19.2	14.8	T	J	B	12	13.7-13.9	20.9	T	J	B	44	13.7-13.8	19.3	U	J	B	59
15.5-17.1	54.5	17.0	17.5	13.1	T	I	B	12	14.0-15.4	17.7	T	J	B	36	13.9-14.2	19.2	T	J	B	59
17.1-17.8	30.2	12.9	13.4	9.0	T	F	B	12	15.5-16.9	16.2	T	I	B	36	14.3-15.4	19.0	T	J	B	58
17.8-18.6	29.6	12.6	13.0	8.6	S	F	B	12	17.0-17.0	16.0	T	I	B	35	15.5-17.0	17.3	T	I	B	58
18.6-21.9	29.0	11.6	12.6	8.2	S	F	B	7	17.1-17.7	12.2	T	F	B	35	17.1-18.2	13.1	T	F	B	58
21.9-23.0	27.0	11.2	12.1	7.7	R	E	B	7	17.8-19.6	11.8	S	F	B	35	18.3-21.8	12.9	S	F	B	58
23.0-25.6	24.8	10.1	10.6	6.2	P	E	B	7	19.7-20.6	11.7	S	F	B	34	21.9-22.6	12.6	S	E	B	58
25.6-27.0	22.7	9.8	10.2	5.9	P	D	B	7	20.7-21.8	11.3	S	F	B	31	22.7-23.9	12.4	R	E	B	58
27.0-27.5	22.4	9.6	10.0	5.7	O	D	B	7	21.9-22.9	10.8	R	E	B	31	24.0-25.5	11.3	P	E	B	58
27.5-35.6	21.9	9.4	9.7	5.4	L	D	B	7	23.0-25.5	9.3	P	E	B	31	25.6-31.6	11.0	P	D	B	58
35.6-41.5	20.9	8.9	9.1	4.7	E	D	B	7	25.6-26.9	9.0	P	D	B	31	31.7-32.0	10.8	O	D	B	58
41.5-41.8	18.4	8.5	8.6	4.3	E	C	B	7	27.0-27.4	8.8	O	D	B	31	32.1-41.4	10.6	L	D	B	58
41.8-45.0	18.4	8.5	8.6	4.3	E	B	B	7	27.5-35.5	8.5	L	D	B	31	41.5-41.7	10.2	L	C	B	58
45.0-59.2	18.0	8.3	8.4	4.0	C	B	B	7	35.6-41.4	7.8	E	D	B	31	41.8-41.9	10.2	L	B	B	58
59.2-59.4	17.4	8.0	8.0	3.7	B	B	B	7	41.5-41.7	7.4	E	C	B	31	42.0-52.7	9.7	E	B	B	58
59.4-65.9	17.0	7.9	7.9	3.6	B	A	B	7	41.8-44.9	7.4	E	B	B	31	52.8-57.8	9.5	C	B	B	58
65.9-91.5	16.3	6.9	7.5	3.1	B	A	B	6	45.0-59.1	7.2	C	B	B	31	57.9-59.3	7.2	C	B	B	54
91.5-99.5	15.9	6.2	7.2	2.9	B	A	B	5	59.2-59.3	6.8	B	B	B	31	59.4-68.7	7.2	C	A	B	54
99.5-75.5	15.5	6.0	6.9	2.6	A	A	B	5	59.4-81.5	6.7	B	A	B	31	68.8-69.9	6.5	C	A	B	51
75.5-108.1	15.5	6.0	6.9	2.6	A	A	B	5	81.6-89.5	5.6	B	A	B	30	70.0-72.1	6.2	B	A	B	51
108.1-110.3	15.4	5.8	6.8	2.5	A	A	B	3	89.6-97.5	5.0	B	A	B	26	72.2-117.1	6.2	B	A	B	50
110.3-123.0	15.3	5.6	6.7	2.4	A	A	B	1	97.6-99.4	4.9	B	A	B	25	117.2-122.9	6.0	A	A	B	50
123.0-	14.5	4.5	2.0	2.1	A	A	A	1	99.5-122.9	4.7	A	A	B	25	123.0-	5.0	A	A	A	50
									123.0-	3.9	A	A	A	25						

A-21

Table A-15. 500 kg- TNT Medium Level of Protection

STANDOFF DISTANCE IN METERS	% Increase				Construction Type				STANDOFF DISTANCE IN METERS	%Δ	Construction Type				STANDOFF DISTANCE IN METERS	%Δ	Construction Type			
	ADMIN FACILITY	MEDICAL CLINIC	BARRACKS (EXT ENT)	BARRACKS (INT ENT)	Walls	Windows	Doors	Roofs			DINING FACILITY	Walls	Windows	Doors			Roofs	SPECIAL STRUCTURE	Walls	Windows
16.9-17.4	43.8	31.1	77.3	15.9	U	F	I	20	17.1-17.4	25.6	U	F	I	44	17.1-17.4	27.5	V	F	I	60
17.5-19.0	43.6	31.1	77.1	15.8	T	F	I	20	17.5-19.5	25.5	T	F	I	44	17.5-18.1	27.2	U	F	I	60
19.1-21.8	43.3	30.7	77.0	15.7	T	F	I	19	19.6-21.8	22.3	T	F	I	36	18.2-18.6	27.1	T	F	I	60
21.9-21.9	41.7	30.4	76.7	15.4	T	E	I	19	21.9-21.9	22.0	T	E	I	36	18.7-20.1	26.8	T	F	I	59
22.0-22.6	40.4	28.7	68.9	14.8	T	E	H	19	22.0-22.6	20.8	T	E	H	36	20.2-21.8	26.6	T	F	I	58
22.7-25.4	39.8	28.4	68.5	14.4	S	E	H	19	22.7-25.1	20.4	S	E	H	36	21.9-21.9	26.3	T	E	I	58
25.5-25.5	36.5	23.1	66.2	12.2	S	E	H	7	25.2-25.5	20.2	S	E	H	35	22.0-23.7	24.6	T	E	H	58
25.6-28.0	34.5	22.8	65.9	11.9	S	D	H	7	25.6-28.0	19.9	S	D	H	35	23.8-25.5	24.3	S	E	H	58
28.1-29.2	34.1	22.6	65.6	11.6	R	D	H	7	28.1-28.5	19.6	R	D	H	35	25.6-29.2	24.0	S	D	H	58
29.3-29.6	32.8	21.0	58.2	11.0	R	D	G	7	28.6-29.2	19.5	R	D	H	34	29.3-29.5	22.4	S	D	G	58
29.7-39.3	30.6	19.9	56.7	9.5	P	D	G	7	29.3-29.6	18.3	R	D	G	34	29.6-31.7	22.2	R	D	G	58
39.4-41.4	30.2	19.7	56.5	9.3	N	D	G	7	29.7-30.3	16.8	P	D	G	34	31.8-41.4	21.1	P	D	G	58
41.5-41.7	27.7	19.3	56.0	8.9	N	C	G	7	30.4-39.3	16.5	P	D	G	31	41.5-41.7	20.7	P	C	G	58
41.8-42.4	27.6	19.3	56.0	8.8	N	B	G	7	39.4-41.4	16.2	N	D	G	31	41.8-42.2	20.7	P	B	G	58
42.5-46.9	25.1	16.1	41.2	7.7	N	B	F	7	41.5-41.7	15.8	N	C	G	31	42.3-42.4	20.5	N	B	G	58
47.0-47.1	24.7	15.9	41.0	7.4	L	B	F	7	41.8-42.4	15.8	N	B	G	31	42.5-47.1	17.3	N	B	F	58
47.2-59.0	24.1	15.0	37.3	7.1	L	B	E	7	42.5-46.9	13.4	N	B	F	31	47.2-53.4	16.5	N	B	E	58
59.1-59.3	23.7	14.6	35.2	7.0	L	B	D	7	47.0-47.1	13.1	L	B	F	31	53.5-59.0	16.3	M	B	E	58
59.4-62.6	23.3	14.5	35.1	6.9	L	A	D	7	47.2-59.0	12.6	L	B	E	31	59.1-59.3	15.9	M	B	D	58
62.7-77.8	22.3	14.1	34.5	6.2	E	A	D	7	59.1-59.3	12.2	L	B	D	31	59.4-60.0	15.8	M	A	D	58
77.9-87.2	21.9	13.9	34.2	6.0	C	A	D	7	59.4-62.6	12.2	L	A	D	31	60.1-79.5	15.7	L	A	D	58
87.3-107.0	21.6	13.4	32.0	5.8	C	A	C	7	62.7-77.8	11.5	E	A	D	31	79.6-81.2	13.5	L	A	D	54
107.1-117.1	21.0	13.1	31.7	5.4	B	A	C	7	77.9-87.2	11.2	C	A	D	31	81.3-87.2	13.0	E	A	D	54
117.2-122.9	19.9	11.4	30.9	4.7	B	A	C	5	87.3-107.0	10.9	C	A	C	31	87.3-93.9	12.5	E	A	C	54

A-22

Table A-15 (continued). 500 kg- TNT Medium Level of Protection

STANDOFF DISTANCE IN METERS	% Increase				Construction Type				STANDOFF DISTANCE IN METERS	%Δ	Construction Type				STANDOFF DISTANCE IN METERS	%Δ	Construction Type			
	ADMIN FACILITY	MEDICAL CLINIC	BARRACKS (EXT ENT)	BARRACKS (INT ENT)	Walls	Windows	Doors	Roofs			DINING FACILITY	Walls	Windows	Doors			Roofs	SPECIAL STRUCTURE	Walls	Windows
123.0-139.0	15.1	5.2	2.5	2.5	B	A	A	5	107.1-111.1	10.5	B	A	C	31	94.0-96.7	11.8	E	A	C	51
139.1-146.1	15.0	5.0	2.4	2.4	B	A	A	3	111.2-122.0	9.4	B	A	C	30	96.8-101.2	11.7	C	A	C	51
146.2-179.4	14.8	4.7	2.3	2.3	B	A	A	1	122.1-122.9	8.8	B	A	C	26	101.3-122.9	11.6	C	A	C	50
179.5-	14.5	4.5	2.0	2.1	A	A	A	1	123.0-130.7	4.2	B	A	A	26	123.0-137.0	5.4	C	A	A	50
									130.8-179.4	4.2	B	A	A	25	137.1-219.9	5.2	B	A	A	50
									179.5-	3.9	A	A	A	25	220.0-	5.0	A	A	A	50

Table A-16. 500 kg- TNT High Level of Protection

STANDOFF DISTANCE IN METERS	% Increase				Construction Type				STANDOFF DISTANCE IN METERS	%Δ	Construction Type				STANDOFF DISTANCE IN METERS	%Δ	Construction Type			
	ADMIN FACILITY	MEDICAL CLINIC	BARRACKS (EXT ENT)	BARRACKS (INT ENT)	Walls	Windows	Doors	Roofs			DINING FACILITY	Walls	Windows	Doors			Roofs	SPECIAL STRUCTURE	Walls	Windows
24.4-25.1	62.0	37.2	82.0	20.6	W	H	I	24	24.4-25.1	30.9	W	H	I	48	26.8-27.9	35.5	W	H	H	72
25.2-28.0	60.7	35.5	74.2	20.0	W	H	H	24	25.2-27.9	29.6	W	H	H	48	28.0-28.9	33.6	W	H	H	69
28.0-29.0	59.5	33.6	73.4	19.2	W	H	H	21	28.0-28.9	28.3	W	H	H	45	29.0-32.4	33.4	W	G	H	69
29.0-32.5	58.0	33.4	73.1	18.9	W	G	H	21	29.0-33.4	28.1	W	G	H	45	32.5-33.4	28.5	W	G	H	60
32.5-33.5	54.5	27.7	70.7	16.6	W	G	H	12	33.5-35.0	26.9	W	G	G	45	33.5-39.9	26.9	W	G	G	60
33.5-35.1	53.2	26.1	63.3	16.1	W	G	G	12	35.1-36.2	26.3	V	G	G	45	40.0-40.8	26.5	V	G	G	60
35.1-36.3	52.3	25.7	62.7	15.5	V	G	G	12	36.3-42.6	25.8	T	G	G	45	40.9-41.1	26.1	T	G	G	60
36.3-48.6	51.6	25.3	62.2	15.0	T	G	G	12	42.7-48.5	21.9	T	G	G	36	41.2-44.3	25.8	T	G	G	59
48.6-51.2	49.0	22.1	47.4	13.8	T	G	F	12	48.6-51.1	19.6	T	G	F	36	44.4-48.5	25.6	T	G	G	58
51.2-53.3	35.6	19.8	45.1	11.5	T	F	F	12	51.2-53.8	17.4	T	F	F	36	48.6-51.1	22.4	T	G	F	58
53.3-53.9	35.0	18.8	44.7	11.1	T	F	F	7	53.9-55.4	16.9	T	F	E	36	51.2-53.8	20.1	T	F	F	58
53.9-56.7	34.3	18.0	41.0	10.8	T	F	E	7	55.5-56.6	16.7	T	F	E	35	53.9-66.2	19.3	T	F	E	58
56.7-60.7	33.7	17.7	40.6	10.4	S	F	E	7	56.7-60.6	16.3	S	F	E	35	66.3-67.4	19.0	S	F	E	58
60.7-67.5	31.1	16.5	38.9	8.7	P	F	E	7	60.7-61.9	14.6	P	F	E	35	67.5-69.1	18.5	S	F	D	58
67.5-69.2	30.8	16.0	36.8	8.5	P	F	D	7	62.0-65.6	14.4	P	F	E	34	69.2-69.7	18.2	S	E	D	58
69.2-71.3	29.2	15.8	36.5	8.3	P	E	D	7	65.7-67.4	14.1	P	F	E	31	69.8-71.2	17.0	P	E	D	58
71.3-76.9	27.1	15.4	36.2	7.9	P	D	D	7	67.5-69.1	13.7	P	F	D	31	71.3-93.1	16.6	P	D	D	58
76.9-99.8	26.8	15.3	35.9	7.7	O	D	D	7	69.2-71.2	13.5	P	E	D	31	93.2-99.7	16.5	O	D	D	58
99.8-108.5	25.9	14.6	33.5	7.2	L	D	C	7	71.3-76.8	13.2	P	D	D	31	99.8-108.4	16.0	O	D	C	58
108.5-126.5	23.4	14.1	33.0	6.8	L	C	C	7	76.9-99.7	13.0	O	D	D	31	108.5-120.5	15.6	O	C	C	58
126.5-130.7	23.4	14.1	33.0	6.8	L	B	C	7	99.8-108.4	12.3	L	D	C	31	120.6-126.4	15.5	N	C	C	58
130.7-145.1	22.4	13.7	32.4	6.1	E	B	C	7	108.5-126.4	11.9	L	C	C	31	126.5-128.7	15.5	N	B	C	58
145.1-146.8	21.9	13.6	32.3	6.1	E	A	C	7	126.5-130.6	11.9	L	B	C	31	128.8-145.0	15.3	L	B	C	58
146.8-151.8	21.6	13.4	32.0	5.8	D	A	C	7	130.7-145.0	11.2	E	B	C	31	145.1-158.3	15.3	L	A	C	58

A-24

Table A-16 (continued). 500 kg- TNT High Level of Protection

STANDOFF DISTANCE IN METERS	% Increase				Construction Type				STANDOFF DISTANCE IN METERS	%Δ	Construction Type				STANDOFF DISTANCE IN METERS	%Δ	Construction Type			
	ADMIN FACILITY	MEDICAL CLINIC	BARRACKS (EXT ENT)	BARRACKS (INT ENT)	Walls	Windows	Doors	Roofs			DINING FACILITY	Walls	Windows	Doors			Roofs	SPECIAL STRUCTURE	Walls	Windows
151.8-212.5	20.9	12.3	31.6	5.4	D	A	C	6	145.1-146.7	11.1	E	A	C	31	158.4-165.2	13.0	L	A	C	54
212.5-238.0	20.5	11.7	31.3	5.1	D	A	C	5	146.8-215.3	10.9	D	A	C	31	165.3-176.9	12.5	E	A	C	54
238.0-247.1	15.7	5.4	2.8	2.9	D	A	A	5	215.4-234.2	9.8	D	A	C	30	177.0-186.5	12.4	D	A	C	54
247.1-250.3	15.1	5.2	2.5	2.5	B	A	A	5	234.3-237.9	9.2	D	A	C	26	186.6-202.5	11.7	D	A	C	51
250.3-270.6	15.0	5.0	2.4	2.4	B	A	A	3	238.0-247.0	4.6	D	A	A	26	202.6-237.9	11.6	D	A	C	50
270.6-	14.8	4.7	2.3	2.3	B	A	A	1	247.1-247.8	4.2	B	A	A	26	238.0-	5.2	B	A	A	50
									247.9-	4.2	B	A	A	25						

Table A-17. 2000 kg- TNT Very Low Level of Protection

STANDOFF DISTANCE IN METERS	% Increase				Construction Type				STANDOFF DISTANCE IN METERS	%Δ	Construction Type				STANDOFF DISTANCE IN METERS	%Δ	Construction Type			
	ADMIN FACILITY	MEDICAL CLINIC	BARRACKS (EXT ENT)	BARRACKS (INT ENT)	Walls	Windows	Doors	Roofs			DINING FACILITY	Walls	Windows	Doors			Roofs	SPECIAL STRUCTURE	Walls	Windows
25.8-26.1	64.6	18.8	19.4	14.9	U	J	B	12	25.9-26.1	21.1	U	J	B	44	25.9-26.5	19.9	V	J	B	60
26.2-29.2	64.5	18.7	19.2	14.8	T	J	B	12	26.2-29.2	20.9	T	J	B	44	26.6-27.2	19.6	U	J	B	60
29.3-30.7	54.5	17.0	17.5	13.1	T	I	B	12	29.3-29.9	19.4	T	I	B	44	27.3-28.0	19.5	T	J	B	60
30.8-32.2	51.9	15.8	15.8	11.4	Q	I	B	12	30.0-30.7	16.2	T	I	B	36	28.1-29.2	19.2	T	J	B	59
32.3-39.9	27.6	11.7	11.7	7.3	Q	F	B	12	30.8-32.2	14.4	Q	I	B	36	29.3-30.5	17.5	T	I	B	59
40.0-40.1	26.7	11.2	11.1	6.7	O	F	B	12	32.3-35.9	10.6	Q	F	B	36	30.6-32.2	17.3	T	I	B	58
40.2-40.4	26.1	10.2	10.6	6.3	O	F	B	7	36.0-39.9	10.5	Q	F	B	35	32.3-35.2	13.1	T	F	B	58
40.5-41.1	24.4	9.9	10.4	6.0	O	E	B	7	40.0-40.4	9.8	O	F	B	35	35.3-40.4	11.9	Q	F	B	58
41.2-47.1	24.0	9.7	10.1	5.7	L	E	B	7	40.5-41.1	9.6	O	E	B	35	40.5-46.4	11.6	Q	E	B	58
47.2-53.7	21.9	9.4	9.7	5.4	L	D	B	7	41.2-41.9	9.3	L	E	B	35	46.5-47.1	11.2	O	E	B	58
53.8-67.5	20.9	8.9	9.1	4.7	E	D	B	7	42.0-44.2	9.1	L	E	B	34	47.2-47.6	10.8	O	D	B	58
67.6-71.8	20.6	8.7	8.8	4.5	C	D	B	7	44.3-47.1	8.8	L	E	B	31	47.7-63.2	10.6	L	D	B	58
71.9-72.4	18.0	8.3	8.4	4.0	C	C	B	7	47.2-53.7	8.5	L	D	B	31	63.3-71.8	10.1	E	D	B	58
72.5-92.3	18.0	8.3	8.4	4.0	C	B	B	7	53.8-67.5	7.8	E	D	B	31	71.9-72.4	9.7	E	C	B	58
92.4-103.5	17.4	8.0	8.0	3.7	B	B	B	7	67.6-71.8	7.6	C	D	B	31	72.5-79.4	9.7	E	B	B	58
103.6-118.6	17.0	7.9	7.9	3.6	B	A	B	7	71.9-72.4	7.2	C	C	B	31	79.5-103.5	9.5	C	B	B	58
118.7-154.9	16.3	6.9	7.5	3.1	B	A	B	6	72.5-92.3	7.2	C	B	B	31	103.6-109.7	9.4	C	A	B	58
155.0-164.1	16.0	6.7	7.2	2.9	A	A	B	6	92.4-94.3	6.8	B	B	B	31	109.8-114.3	9.2	B	A	B	58
164.2-172.9	15.5	6.0	6.9	2.6	A	A	B	5	94.4-99.1	5.2	B	B	B	28	114.4-138.2	9.2	B	A	B	58
173.0-197.5	14.7	5.0	2.2	2.2	A	A	A	5	99.2-103.5	5.0	B	B	B	25	138.3-144.1	6.2	B	A	B	51
197.6-199.3	14.6	4.8	2.1	2.2	A	A	A	3	103.6-154.9	4.9	B	A	B	25	144.2-172.9	6.2	B	A	B	50
199.4-	14.5	4.5	2.0	2.1	A	A	A	1	155.0-172.9	4.7	A	A	B	25	173.0-183.9	5.2	B	A	A	50
									173.0-	3.9	A	A	A	25	184.0-	5.0	A	A	A	50

A-26

Table A-18. 2000 kg- TNT Low Level of Protection

STANDOFF DISTANCE IN METERS	% Increase				Construction Type				STANDOFF DISTANCE IN METERS	%Δ	Construction Type				STANDOFF DISTANCE IN METERS	%Δ	Construction Type			
	ADMIN FACILITY	MEDICAL CLINIC	BARRACKS (EXT ENT)	BARRACKS (INT ENT)	Walls	Windows	Doors	Roofs			DINING FACILITY	Walls	Windows	Doors			Roofs	SPECIAL STRUCTURE	Walls	Windows
25.9-28.7	68.1	23.8	21.8	17.2	V	J	B	20	25.9-28.9	21.5	V	J	B	44	25.9-28.7	23.8	V	J	B	68
28.8-28.9	65.2	19.1	19.7	15.3	V	J	B	12	29.0-29.2	21.1	U	J	B	44	28.8-29.2	19.9	V	J	B	60
29.0-29.2	64.6	18.8	19.4	14.9	U	J	B	12	29.3-32.2	19.4	T	I	B	44	29.3-30.3	18.2	V	I	B	60
29.3-38.3	54.5	17.0	17.5	13.1	T	I	B	12	32.3-33.4	15.6	T	F	B	44	30.4-30.9	17.9	U	I	B	60
38.4-32.2	53.9	16.8	17.2	12.7	S	I	B	12	33.5-36.7	15.3	T	F	B	43	31.0-32.2	17.8	T	I	B	60
32.3-40.4	29.6	12.6	13.0	8.6	S	F	B	12	36.8-38.3	12.4	T	F	B	36	32.3-34.6	13.7	T	F	B	60
40.5-47.1	28.0	12.3	12.8	8.4	S	E	B	12	38.4-40.4	12.0	S	F	B	36	34.7-37.7	13.3	T	F	B	59
47.2-47.5	25.9	12.0	12.4	8.0	S	D	B	12	40.5-45.2	11.7	S	E	B	36	37.8-40.4	13.1	T	F	B	58
47.6-48.6	25.5	11.8	12.2	7.8	R	D	B	12	45.3-47.1	11.6	S	E	B	35	40.5-40.7	12.9	T	E	B	58
48.7-48.8	23.3	10.7	10.7	6.3	P	D	B	12	47.2-47.5	11.2	S	D	B	35	40.8-47.1	12.6	S	E	B	58
48.9-66.0	22.7	9.8	10.2	5.9	P	D	B	7	47.6-48.6	11.0	R	D	B	35	47.2-50.8	12.2	S	D	B	58
66.1-60.9	22.3	9.6	10.0	5.6	N	D	B	7	48.7-51.9	9.5	P	D	B	35	50.9-52.8	12.0	R	D	B	58
61.0-71.8	21.9	9.4	9.7	5.4	L	D	B	7	52.0-55.0	9.4	P	D	B	34	52.9-71.8	11.0	P	D	B	58
71.9-72.4	19.4	8.9	9.3	4.9	L	C	B	7	55.1-60.9	9.0	P	D	B	31	71.9-72.0	10.5	P	C	B	58
72.5-79.7	19.3	8.9	9.3	4.9	L	B	B	7	61.0-71.8	8.5	L	D	B	31	72.1-72.4	10.4	N	C	B	58
79.8-99.7	18.4	8.5	8.6	4.3	E	B	B	7	71.9-72.4	8.1	L	C	B	31	72.5-74.6	10.3	N	B	B	58
99.8-102.7	18.0	8.3	8.4	4.0	D	B	B	7	72.5-79.7	8.1	L	B	B	31	74.7-98.4	10.2	L	B	B	58
102.8-103.5	18.0	8.3	8.4	4.0	C	B	B	7	79.8-99.7	7.4	E	B	B	31	98.5-103.5	9.7	E	B	B	58
103.6-119.8	17.5	8.2	8.3	3.9	C	A	B	7	99.8-102.7	7.2	D	B	B	31	103.6-124.6	9.6	E	A	B	58
119.9-134.1	17.5	8.2	8.3	3.9	C	A	B	7	102.8-103.5	7.2	C	B	B	31	124.7-125.6	9.4	D	A	B	58
134.2-135.7	16.9	7.1	7.8	3.5	C	A	B	6	103.6-135.7	7.1	C	A	B	31	125.7-136.6	9.4	C	A	B	58
135.8-185.5	16.3	6.9	7.5	3.1	B	A	B	6	135.8-179.0	6.7	B	A	B	31	136.7-163.6	7.2	C	A	B	54
185.6-224.0	15.9	6.2	7.2	2.9	B	A	B	5	179.1-194.9	5.6	B	A	B	30	163.7-167.6	6.5	C	A	B	54
224.1-228.6	15.8	6.0	7.1	2.8	B	A	B	3	195.0-214.6	5.0	B	A	B	26	167.7-172.2	6.2	B	A	B	54

A-27

Table A-18 (continued). 2000 kg- TNT Low Level of Protection

STANDOFF DISTANCE IN METERS	% Increase				Construction Type				STANDOFF DISTANCE IN METERS	%Δ	Construction Type				STANDOFF DISTANCE IN METERS	%Δ	Construction Type			
	ADMIN FACILITY	MEDICAL CLINIC	BARRACKS (EXT ENT)	BARRACKS (INT ENT)	Walls	Windows	Doors	Roofs			DINING FACILITY	Walls	Windows	Doors			Roofs	SPECIAL STRUCTURE	Walls	Windows
228.7-234.3	15.6	5.7	7.0	2.7	B	A	B	1	214.7-234.3	4.9	B	A	B	25	172.3-250.9	6.2	B	A	B	50
234.4-250.9	15.3	5.6	6.7	2.4	A	A	B	1	234.4-250.9	4.7	A	A	B	25	251.0-284.2	5.2	B	A	A	50
251.0-	14.5	4.5	2.0	2.1	A	A	A	1	251.0-	3.9	A	A	A	25	284.3-	5.0	A	A	A	50

Table A-19. 2000 kg- TNT Medium Level of Protection

STANDOFF DISTANCE IN METERS	% Increase				Construction Type				STANDOFF DISTANCE IN METERS	%Δ	Construction Type				STANDOFF DISTANCE IN METERS	%Δ	Construction Type			
	ADMIN FACILITY	MEDICAL CLINIC	BARRACKS (EXT ENT)	BARRACKS (INT ENT)	Walls	Windows	Doors	Roofs			DINING FACILITY	Walls	Windows	Doors			Roofs	SPECIAL STRUCTURE	Walls	Windows
22.6-28.9	80.1	38.6	84.4	23.1	W	J	I	21	27.2-28.9	32.6	W	J	I	45	23.8-29.2	38.6	W	J	I	69
29.0-29.2	79.2	38.2	83.9	22.5	V	J	I	21	29.0-29.2	32.0	V	J	I	45	29.3-30.8	36.9	W	I	I	69
29.3-32.2	69.2	36.5	82.2	20.8	V	I	I	21	29.3-32.2	30.4	V	I	I	45	30.9-32.2	36.5	V	I	I	69
32.3-33.8	44.9	32.3	78.1	16.7	V	F	I	21	32.3-33.8	26.6	V	F	I	45	32.3-33.8	32.3	V	F	I	69
33.9-34.9	44.3	31.4	77.7	16.3	V	F	I	20	33.9-34.9	26.0	V	F	I	44	33.9-34.9	31.4	V	F	I	68
35.0-35.2	43.0	29.7	69.9	15.7	V	F	H	20	35.0-35.2	24.7	V	F	H	44	35.0-37.7	29.7	V	F	H	68
35.3-35.4	42.4	29.4	69.5	15.3	U	F	H	20	35.3-35.4	24.3	U	F	H	44	37.8-38.4	29.4	U	F	H	68
35.5-40.2	42.3	29.4	69.4	15.2	T	F	H	20	35.5-40.4	24.2	T	F	H	44	38.5-40.2	29.4	T	F	H	68
40.3-40.4	39.3	24.7	67.3	13.3	T	F	H	12	40.5-44.2	24.0	T	E	H	44	40.3-40.4	25.4	T	F	H	60
40.5-46.1	37.7	24.4	67.0	13.0	T	E	H	12	44.3-46.1	23.7	T	E	H	43	40.5-46.5	25.2	T	E	H	60
46.2-46.5	37.1	24.1	66.6	12.6	S	E	H	12	46.2-46.5	23.3	S	E	H	43	46.6-47.1	23.6	T	E	G	60
46.6-47.1	35.9	22.5	59.2	12.0	S	E	G	12	46.6-47.1	22.1	S	E	G	43	47.2-49.7	23.2	T	D	G	60
47.2-57.7	33.8	22.1	58.9	11.7	S	D	G	12	47.2-51.8	21.8	S	D	G	43	49.8-50.5	22.8	T	D	G	59
57.8-59.1	33.4	21.9	58.6	11.4	R	D	G	12	51.9-57.7	18.8	S	D	G	36	50.6-53.5	22.5	S	D	G	59
59.2-66.6	31.2	20.9	57.1	9.9	P	D	G	12	57.8-59.1	18.6	R	D	G	36	53.6-63.7	22.4	S	D	G	58
66.7-67.4	30.6	19.9	56.7	9.5	P	D	G	7	59.2-66.6	17.1	P	D	G	36	63.8-66.8	22.2	R	D	G	58
67.5-71.8	28.1	16.7	41.9	8.4	P	D	F	7	66.7-67.4	16.9	P	D	G	35	66.9-67.4	21.1	P	D	G	58
71.9-72.4	25.6	16.2	41.5	8.0	P	C	F	7	67.5-71.8	14.6	P	D	F	35	67.5-71.8	17.9	P	D	F	58
72.5-74.9	25.5	16.2	41.5	7.9	P	B	F	7	71.9-72.4	14.2	P	C	F	35	71.9-72.4	17.5	P	C	F	58
75.0-80.9	24.9	15.4	37.8	7.7	P	B	E	7	72.5-74.9	14.2	P	B	F	35	72.5-74.9	17.5	P	B	F	58
81.0-93.7	24.5	15.2	37.5	7.4	N	B	E	7	75.0-75.3	13.6	P	B	E	35	75.0-91.4	16.7	P	B	E	58
93.8-94.2	24.1	14.8	35.5	7.2	N	B	D	7	75.4-80.3	13.4	P	B	E	34	91.5-93.7	16.5	N	B	E	58
94.3-103.5	23.7	14.6	35.2	7.0	L	B	D	7	80.4-80.9	13.1	P	B	E	31	93.8-103.5	16.0	N	B	D	58
103.6-127.1	23.3	14.5	35.1	6.9	L	A	D	7	81.0-93.7	12.8	N	B	E	31	103.6-118.1	15.9	N	A	D	58

A-29

Table A-19 (continued). 2000 kg- TNT Medium Level of Protection

STANDOFF DISTANCE IN METERS	% Increase				Construction Type				STANDOFF DISTANCE IN METERS	%Δ	Construction Type				STANDOFF DISTANCE IN METERS	%Δ	Construction Type			
	ADMIN FACILITY	MEDICAL CLINIC	BARRACKS (EXT ENT)	BARRACKS (INT ENT)	Walls	Windows	Doors	Roofs			DINING FACILITY	Walls	Windows	Doors			Roofs	SPECIAL STRUCTURE	Walls	Windows
127.2-138.0	22.3	14.1	34.5	6.2	E	A	D	7	93.8-94.2	12.5	N	B	D	31	118.2-131.1	15.8	M	A	D	58
138.1-163.3	21.9	13.6	32.3	6.1	E	A	C	7	94.3-103.5	12.2	L	B	D	31	131.2-138.0	15.7	L	A	D	58
163.4-165.2	21.3	12.5	31.8	5.6	E	A	C	6	103.6-127.1	12.2	L	A	D	31	138.1-179.1	15.3	L	A	C	58
165.3-224.4	20.9	12.3	31.6	5.4	C	A	C	6	127.2-138.0	11.5	E	A	D	31	179.2-181.0	14.8	E	A	C	58
224.5-228.4	20.3	12.1	31.2	5.0	B	A	C	6	138.1-165.2	11.1	E	A	C	31	181.1-216.0	12.5	E	A	C	54
228.5-250.9	19.9	11.4	30.9	4.7	B	A	C	5	165.3-224.4	10.9	C	A	C	31	216.1-220.1	11.8	E	A	C	51
251.0-275.3	15.1	5.2	2.5	2.5	B	A	A	5	224.5-234.1	10.5	B	A	C	31	220.2-233.1	11.7	C	A	C	51
275.4-289.3	15.0	5.0	2.4	2.4	B	A	A	3	234.2-250.9	9.4	B	A	C	30	233.2-250.9	11.6	C	A	C	50
289.4-393.2	14.8	4.7	2.3	2.3	B	A	A	1	251.0-253.8	4.8	B	A	A	30	251.0-310.6	5.4	C	A	A	50
393.3-	14.5	4.5	2.0	2.1	A	A	A	1	253.9-273.9	4.2	B	A	A	26	310.7-508.7	5.2	B	A	A	50
									274.0-393.2	4.2	B	A	A	25	508.8-	5.0	A	A	A	50
									393.3-	3.9	A	A	A	25						

A-30

Table A-20. 2000 kg- TNT High Level of Protection

STANDOFF DISTANCE IN METERS	% Increase				Construction Type				STANDOFF DISTANCE IN METERS	%Δ	Construction Type				STANDOFF DISTANCE IN METERS	%Δ	Construction Type			
	ADMIN FACILITY	MEDICAL CLINIC	BARRACKS (EXT ENT)	BARRACKS (INT ENT)	Walls	Windows	Doors	Roofs			DINING FACILITY	Walls	Windows	Doors			Roofs	SPECIAL STRUCTURE	Walls	Windows
42.2-51.4	60.7	35.5	74.2	20.0	W	H	H	24	42.2-51.4	29.6	W	H	H	48	47.2-51.4	35.5	W	H	H	72
51.5-51.5	59.1	35.2	74.0	19.7	W	G	H	24	51.5-51.5	29.4	W	G	H	48	51.5-51.5	35.2	W	G	H	72
51.6-53.2	58.0	33.4	73.1	18.9	W	G	H	21	51.6-53.2	28.1	W	G	H	45	51.6-53.2	33.4	W	G	H	69
53.3-59.6	56.7	31.8	65.8	18.4	W	G	G	21	53.3-59.6	26.9	W	G	G	45	53.3-69.0	31.8	W	G	G	69
59.7-63.5	55.8	31.3	65.2	17.8	V	G	G	21	59.7-63.5	26.3	V	G	G	45	69.1-73.3	31.3	V	G	G	69
63.6-77.0	55.1	31.0	64.7	17.3	T	G	G	21	63.6-77.0	25.8	T	G	G	45	73.4-77.0	31.0	T	G	G	69
77.1-83.1	52.5	27.7	49.9	16.1	T	G	F	21	77.1-83.1	23.4	T	G	F	45	77.1-83.1	27.7	T	G	F	69
83.2-83.5	39.1	25.4	47.6	13.8	T	F	F	21	83.2-83.5	21.3	T	F	F	45	83.2-83.5	25.4	T	F	F	69
83.6-85.6	38.5	24.5	47.2	13.5	T	F	F	20	83.6-85.6	20.6	T	F	F	44	83.6-85.6	24.5	T	F	F	68
85.7-85.9	37.9	23.7	43.5	13.2	T	F	E	20	85.7-97.8	20.1	T	F	E	44	85.7-85.9	23.7	T	F	E	68
86.0-97.8	34.9	19.0	41.4	11.2	T	F	E	12	97.9-107.1	19.7	S	F	E	44	86.0-105.7	19.8	T	F	E	60
97.9-107.1	34.3	18.7	41.0	10.8	S	F	E	12	107.2-108.3	19.3	S	F	D	44	105.8-107.1	19.4	T	F	E	59
107.2-108.6	34.0	18.3	39.0	10.7	S	F	D	12	108.4-108.6	16.1	S	F	D	36	107.2-112.3	19.0	T	F	D	59
108.7-113.0	31.4	17.0	37.2	8.9	P	F	D	12	108.7-113.0	14.4	P	F	D	36	112.4-113.0	18.8	T	F	D	58
113.1-116.0	29.8	16.7	36.9	8.7	P	E	D	12	113.1-116.0	14.1	P	E	D	36	113.1-116.0	18.5	T	E	D	58
116.1-131.0	27.7	16.4	36.6	8.3	P	D	D	12	116.1-138.9	13.8	P	D	D	36	116.1-117.1	18.2	T	D	D	58
131.1-143.6	27.1	15.4	36.2	7.9	P	D	D	7	139.0-143.6	13.6	P	D	D	35	117.2-129.1	17.9	S	D	D	58
143.7-157.8	26.8	15.3	35.9	7.7	O	D	D	7	143.7-153.9	13.4	O	D	D	35	129.2-157.8	16.6	P	D	D	58
157.9-181.2	26.4	14.8	33.8	7.5	O	D	C	7	154.0-157.8	13.3	O	D	D	34	157.9-184.3	16.2	P	D	C	58
181.3-180.6	26.4	14.8	33.7	7.5	N	D	C	7	157.9-163.7	12.9	O	D	C	34	184.4-192.9	15.7	P	C	C	58
180.7-184.3	25.9	14.6	33.5	7.2	L	D	C	7	163.8-180.6	12.6	O	D	C	31	193.0-214.8	15.6	O	C	C	58
184.4-214.8	23.4	14.1	33.0	6.8	L	C	C	7	180.7-184.3	12.3	L	D	C	31	214.9-220.1	15.6	O	B	C	58
214.9-240.8	23.4	14.1	33.0	6.8	L	B	C	7	184.4-214.8	11.9	L	C	C	31	220.2-245.3	15.5	N	B	C	58
240.9-245.3	22.4	13.7	32.4	6.1	E	B	C	7	214.9-240.8	11.9	L	B	C	31	245.4-253.8	15.5	N	A	C	58

A-31

Table A-20 (continued). 2000 kg- TNT High Level of Protection

STANDOFF DISTANCE IN METERS	% Increase				Construction Type				STANDOFF DISTANCE IN METERS	%Δ	Construction Type				STANDOFF DISTANCE IN METERS	%Δ	Construction Type			
	ADMIN FACILITY	MEDICAL CLINIC	BARRACKS (EXT ENT)	BARRACKS (INT ENT)	Walls	Windows	Doors	Roofs			DINING FACILITY	Walls	Windows	Doors			Roofs	SPECIAL STRUCTURE	Walls	Windows
245.4-278.5	21.9	13.6	32.3	6.1	E	A	C	7	240.9-245.3	11.2	E	B	C	31	253.9-333.0	15.3	L	A	C	58
283.7-393.3	21.3	12.5	31.8	5.6	E	A	C	6	245.4-278.4	11.1	E	A	C	31	333.1-340.3	14.8	E	A	C	58
393.4-458.9	20.9	11.8	31.5	5.3	E	A	C	5	278.5-425.5	10.9	D	A	C	31	340.4-371.7	12.5	E	A	C	54
459.0-465.5	16.0	5.6	3.1	3.1	E	A	A	5	425.6-457.1	9.8	D	A	C	30	371.8-400.4	12.4	D	A	C	54
465.6-503.6	15.9	5.4	3.0	3.0	E	A	A	3	457.2-458.9	9.2	D	A	C	26	400.5-437.0	11.7	D	A	C	51
503.7-	15.8	5.2	2.9	2.9	E	A	A	1	459.0-483.7	4.6	D	A	A	26	437.1-458.9	11.6	D	A	C	50
									483.8-	4.5	D	A	A	25	459.0-	5.2	D	A	A	49

Table A-21. 9000 kg- TNT Very Low Level of Protection

STANDOFF DISTANCE IN METERS	% Increase				Construction Type				STANDOFF DISTANCE IN METERS	%Δ	Construction Type				STANDOFF DISTANCE IN METERS	%Δ	Construction Type			
	ADMIN FACILITY	MEDICAL CLINIC	BARRACKS (EXT ENT)	BARRACKS (INT ENT)	Walls	Windows	Doors	Roofs			DINING FACILITY	Walls	Windows	Doors			Roofs	SPECIAL STRUCTURE	Walls	Windows
47.2-53.2	68.7	24.7	22.2	17.6	V	J	B	21	47.2-53.2	22.1	V	J	B	45	47.2-49.7	25.2	W	J	B	69
53.3-56.4	58.7	23.0	20.5	15.9	V	I	B	21	53.3-54.7	20.5	V	I	B	45	49.8-53.2	24.7	V	J	B	69
56.5-59.3	58.0	22.7	20.0	15.4	T	I	B	21	54.8-56.4	19.9	V	I	B	44	53.3-54.7	23.0	V	I	B	69
59.4-67.2	33.7	18.5	15.9	11.3	T	F	B	21	56.5-59.3	19.4	T	I	B	44	54.8-59.3	22.1	V	I	B	68
67.3-71.9	30.2	12.9	13.4	9.0	T	F	B	12	59.4-71.8	15.6	T	F	B	44	59.4-61.1	18.0	V	F	B	68
72.0-73.4	27.6	11.7	11.7	7.3	Q	F	B	12	71.9-71.9	15.3	T	F	B	43	61.2-67.2	17.6	T	F	B	68
73.5-83.7	26.0	11.4	11.4	7.0	Q	E	B	12	72.0-73.4	13.6	Q	F	B	43	67.3-73.4	13.7	T	F	B	60
83.8-93.4	24.0	11.0	11.1	6.7	Q	D	B	12	73.5-83.7	13.3	Q	E	B	43	73.5-80.7	13.4	T	E	B	60
93.5-97.1	23.0	10.6	10.5	6.1	O	D	B	12	83.8-85.1	13.0	Q	D	B	43	80.8-81.4	13.0	T	E	B	59
97.2-112.3	22.5	10.3	10.1	5.7	L	D	B	12	85.2-93.4	10.1	Q	D	B	36	81.5-83.7	12.7	S	E	B	59
112.4-126.4	21.9	9.4	9.7	5.4	L	D	B	7	93.5-97.1	9.4	O	D	B	36	83.8-86.3	12.4	S	D	B	59
126.5-127.0	19.4	8.9	9.3	4.9	L	C	B	7	97.2-102.7	9.1	L	D	B	36	86.4-87.0	11.4	Q	D	B	59
127.1-128.5	19.3	8.9	9.3	4.9	L	B	B	7	102.8-118.6	8.9	L	D	B	35	87.1-105.3	11.3	Q	D	B	58
128.6-165.2	18.4	8.5	8.6	4.3	E	B	B	7	118.7-125.0	8.8	L	D	B	34	105.4-114.5	11.0	P	D	B	58
165.3-183.7	18.0	8.3	8.4	4.0	C	B	B	7	125.1-126.4	8.5	L	D	B	31	114.6-118.1	10.8	O	D	B	58
183.8-225.9	17.5	8.2	8.3	3.9	C	A	B	7	126.5-127.0	8.1	L	C	B	31	118.2-126.4	10.6	L	D	B	58
226.0-236.6	17.0	7.9	7.9	3.6	B	A	B	7	127.1-128.5	8.1	L	B	B	31	126.5-127.0	10.2	L	C	B	58
236.7-307.9	16.3	6.9	7.5	3.1	B	A	B	6	128.6-165.2	7.4	E	B	B	31	127.1-157.9	10.2	L	B	B	58
308.0-327.0	15.5	5.8	2.8	2.8	B	A	A	6	165.3-183.7	7.2	C	B	B	31	158.0-176.4	9.7	E	B	B	58
327.1-399.5	15.1	5.2	2.5	2.5	B	A	A	5	183.8-209.6	7.1	C	A	B	31	176.5-183.7	6.7	E	B	B	50
399.6-399.8	15.0	5.0	2.4	2.4	B	A	A	3	209.7-225.9	5.4	C	A	B	26	183.8-201.7	6.6	E	A	B	50
399.9-403.0	14.6	4.8	2.1	2.2	A	A	A	3	226.0-242.3	5.0	B	A	B	26	201.8-279.5	6.4	C	A	B	50
403.1-	14.5	4.5	2.0	2.1	A	A	A	1	242.4-307.9	4.9	B	A	B	25	279.6-307.9	6.2	B	A	B	50
									308.0-399.8	4.2	B	A	A	25	308.0-476.1	5.2	B	A	A	50
									399.9-	3.9	A	A	A	25	476.2-	5.0	A	A	A	50

A-33

Table A-22. 9000 kg- TNT Low Level of Protection

STANDOFF DISTANCE IN METERS	% Increase				Construction Type				STANDOFF DISTANCE IN METERS	%Δ	Construction Type				STANDOFF DISTANCE IN METERS	%Δ	Construction Type			
	ADMIN FACILITY	MEDICAL CLINIC	BARRACKS (EXT ENT)	BARRACKS (INT ENT)	Walls	Windows	Doors	Roofs			DINING FACILITY	Walls	Windows	Doors			Roofs	SPECIAL STRUCTURE	Walls	Windows
47.2-51.0	69.6	25.2	22.8	18.2	W	J	B	21	47.2-51.0	22.7	W	J	B	45	47.2-53.2	25.2	W	J	B	69
51.1-53.2	68.7	24.7	22.2	17.6	V	J	B	21	51.1-53.3	22.1	V	J	B	45	53.3-54.9	23.5	W	I	B	69
53.3-59.3	58.7	23.0	20.5	15.9	V	I	B	21	53.3-59.4	20.5	V	I	B	45	55.0-59.3	23.0	V	I	B	69
59.4-60.7	34.5	18.9	16.4	11.8	V	F	B	21	59.4-60.7	16.7	V	F	B	45	59.4-60.6	18.9	V	F	B	69
60.8-73.4	33.7	18.5	15.9	11.3	T	F	B	21	60.7-60.8	16.1	V	F	B	44	60.7-66.7	18.0	V	F	B	68
73.5-80.0	32.1	18.2	15.6	11.1	T	E	B	21	60.8-73.5	15.6	T	F	B	44	66.8-73.4	17.6	T	F	B	68
80.1-82.2	31.5	17.9	15.2	10.7	S	E	B	21	73.5-79.5	15.3	T	E	B	44	73.5-79.4	17.3	T	E	B	68
82.3-83.7	28.0	12.3	12.8	8.4	S	E	B	12	79.5-80.1	15.0	T	E	B	43	79.5-82.2	16.9	T	E	B	67
83.8-99.6	25.9	12.0	12.4	8.0	S	D	B	12	80.1-83.8	14.6	S	E	B	43	82.3-83.7	13.4	T	E	B	60
99.7-126.4	23.3	10.7	10.7	6.3	P	D	B	12	83.8-99.7	14.3	S	D	B	43	83.8-89.0	13.0	T	D	B	60
126.5-127.0	20.8	10.3	10.2	5.8	P	C	B	12	99.7-104.2	12.6	P	D	B	43	89.1-99.4	12.8	S	D	B	60
127.1-133.3	20.7	10.3	10.2	5.8	P	B	B	12	104.2-126.5	9.6	P	D	B	36	99.5-106.9	12.4	S	D	B	59
133.4-134.1	19.9	9.9	9.7	5.3	L	B	B	12	126.5-127.1	9.2	P	C	B	36	107.0-113.5	12.2	S	D	B	58
134.2-176.1	19.3	8.9	9.3	4.9	L	B	B	7	127.1-127.5	9.2	P	B	B	36	113.6-114.1	12.0	R	D	B	58
176.2-183.7	18.4	8.5	8.6	4.3	E	B	B	7	127.5-133.4	9.1	P	B	B	35	114.2-126.4	11.0	P	D	B	58
183.8-220.6	17.9	8.4	8.5	4.2	E	A	B	7	133.4-144.7	8.5	L	B	B	35	126.5-127.0	10.5	P	C	B	58
220.7-237.7	17.6	8.2	8.3	4.0	D	A	B	7	144.7-152.4	8.4	L	B	B	34	127.1-160.6	10.5	P	B	B	58
237.8-260.0	17.5	8.2	8.3	3.9	C	A	B	7	152.4-176.2	8.1	L	B	B	31	160.7-175.6	10.3	N	B	B	58
260.1-310.5	16.9	7.1	7.8	3.5	C	A	B	6	176.2-183.8	7.4	E	B	B	31	175.7-183.7	10.2	L	B	B	58
310.6-361.2	16.3	6.9	7.5	3.1	B	A	B	6	183.8-220.7	7.3	E	A	B	31	183.8-234.9	10.1	L	A	B	58
361.3-441.3	15.9	6.2	7.2	2.9	B	A	B	5	220.7-237.8	7.1	D	A	B	31	235.0-298.8	9.6	E	A	B	58
441.4-449.9	15.8	6.0	7.1	2.8	B	A	B	3	237.8-310.6	7.1	C	A	B	31	298.9-302.1	9.4	D	A	B	58
450.0-480.9	15.6	5.7	7.0	2.7	B	A	B	1	310.6-368.0	6.7	B	A	B	31	302.2-307.7	7.2	D	A	B	58
481.0-560.1	14.8	4.7	2.3	2.3	B	A	A	1	368.0-397.4	5.6	B	A	B	30	307.8-365.2	7.2	C	A	B	58

A-34

Table A-22 (continued). 9000 kg- TNT Low Level of Protection

STANDOFF DISTANCE IN METERS	% Increase				Construction Type				STANDOFF DISTANCE IN METERS	%Δ	Construction Type				STANDOFF DISTANCE IN METERS	%Δ	Construction Type			
	ADMIN FACILITY	MEDICAL CLINIC	BARRACKS (EXT ENT)	BARRACKS (INT ENT)	Walls	Windows	Doors	Roofs			DINING FACILITY	Walls	Windows	Doors			Roofs	SPECIAL STRUCTURE	Walls	Windows
560.2-	14.5	4.5	2.0	2.1	A	A	A	1	397.4-440.7	5.0	B	A	B	26	365.3-385.1	6.5	C	A	B	51
									440.7-481.0	4.9	B	A	B	25	385.2-411.0	6.4	C	A	B	50
									481.0-560.2	4.2	B	A	A	25	411.1-480.9	6.2	B	A	B	50
									560.2-	3.9	A	A	A	25	481.0-712.2	5.2	B	A	A	50
														712.3-	5.0	A	A	A	50	

Table A-23. 9000 kg- TNT Medium Level of Protection

STANDOFF DISTANCE IN METERS	% Increase				Construction Type				STANDOFF DISTANCE IN METERS	%Δ	Construction Type				STANDOFF DISTANCE IN METERS	%Δ	Construction Type			
	ADMIN FACILITY	MEDICAL CLINIC	BARRACKS (EXT ENT)	BARRACKS (INT ENT)	Walls	Windows	Doors	Roofs			DINING FACILITY	Walls	Windows	Doors			Roofs	SPECIAL STRUCTURE	Walls	Windows
45.6-48.6	81.2	40.5	85.2	23.8	W	J	I	24	47.2-48.6	33.9	W	J	I	48	49.8-53.1	39.1	W	J	I	71
48.7-53.1	80.3	39.1	84.6	23.2	W	J	I	23	48.7-53.1	32.9	W	J	I	47	53.2-53.2	38.6	W	J	I	69
53.2-53.2	80.1	38.6	84.4	23.1	W	J	I	21	53.2-53.2	32.6	W	J	I	45	53.3-58.0	36.9	W	I	I	69
53.3-58.0	70.1	36.9	82.8	21.4	W	I	I	21	53.3-58.0	31.0	W	I	I	45	58.1-59.3	35.2	W	I	H	69
58.1-59.3	67.9	34.8	74.4	20.2	V	I	H	21	58.1-59.3	29.2	V	I	H	45	59.4-64.0	31.1	W	F	H	69
59.4-69.1	43.6	30.6	70.3	16.1	V	F	H	21	59.4-69.1	25.4	V	F	H	45	64.1-72.8	30.6	V	F	H	69
69.2-73.4	42.8	30.3	69.8	15.6	T	F	H	21	69.2-72.8	24.9	T	F	H	45	72.9-73.4	29.7	V	F	H	68
73.5-77.2	41.2	30.0	69.5	15.3	T	E	H	21	72.9-73.4	24.2	T	F	H	44	73.5-77.2	29.4	V	E	H	68
77.3-83.7	39.9	28.4	62.1	14.7	T	E	G	21	73.5-77.2	24.0	T	E	H	44	77.3-77.6	27.8	V	E	G	68
83.8-91.1	37.9	28.0	61.8	14.4	T	D	G	21	77.3-83.7	22.8	T	E	G	44	77.7-83.7	27.5	T	E	G	68
91.2-95.4	37.3	27.8	61.4	14.0	S	D	G	21	83.8-91.1	22.4	T	D	G	44	83.8-95.4	27.1	T	D	G	68
95.5-101.1	36.5	26.5	60.8	13.5	S	D	G	19	91.2-95.4	22.0	S	D	G	44	95.5-104.2	26.8	T	D	G	67
101.2-111.5	36.1	26.3	60.5	13.2	R	D	G	19	95.5-101.1	21.8	S	D	G	43	104.3-111.5	26.5	S	D	G	67
111.6-113.9	33.6	23.1	45.7	12.0	R	D	F	19	101.2-111.5	21.5	R	D	G	43	111.6-113.5	23.2	S	D	F	67
114.0-115.0	30.9	18.7	43.8	10.2	R	D	F	12	111.6-115.0	19.1	R	D	F	43	113.6-113.9	23.1	R	D	F	67
115.1-124.1	28.7	17.6	42.4	8.8	P	D	F	12	115.1-124.1	17.6	P	D	F	43	114.0-124.1	19.5	R	D	F	60
124.2-126.4	28.1	16.8	38.7	8.5	P	D	E	12	124.2-126.4	17.1	P	D	E	43	124.2-126.4	18.7	R	D	E	60
126.5-127.0	25.5	16.4	38.2	8.1	P	C	E	12	126.5-127.0	16.7	P	C	E	43	126.5-127.0	18.3	R	C	E	60
127.1-155.3	25.5	16.4	38.2	8.0	P	B	E	12	127.1-143.4	16.6	P	B	E	43	127.1-135.6	18.3	R	B	E	60
155.4-161.3	25.1	15.9	36.2	7.9	P	B	D	12	143.5-155.3	13.7	P	B	E	36	135.7-140.0	17.2	P	B	E	60
161.4-172.6	24.7	15.8	35.9	7.6	N	B	D	12	155.4-161.3	13.4	P	B	D	36	140.1-148.5	16.8	P	B	E	59
172.7-183.7	24.1	14.8	35.5	7.2	N	B	D	7	161.4-178.0	13.1	N	B	D	36	148.6-155.3	16.7	P	B	E	58
183.8-184.1	23.7	14.7	35.4	7.2	N	A	D	7	178.1-183.7	13.0	N	B	D	35	155.4-183.7	16.2	P	B	D	58
184.2-228.9	23.3	14.5	35.1	6.9	L	A	D	7	183.8-184.1	12.9	N	A	D	35	183.8-192.2	16.1	P	A	D	58

A-36

Table A-23 (continued). 9000 kg- TNT Medium Level of Protection

STANDOFF DISTANCE IN METERS	% Increase				Construction Type				STANDOFF DISTANCE IN METERS	%Δ	Construction Type				STANDOFF DISTANCE IN METERS	%Δ	Construction Type			
	ADMIN FACILITY	MEDICAL CLINIC	BARRACKS (EXT ENT)	BARRACKS (INT ENT)	Walls	Windows	Doors	Roofs			DINING FACILITY	Walls	Windows	Doors			Roofs	SPECIAL STRUCTURE	Walls	Windows
229.0-249.7	22.9	14.0	32.9	6.7	L	A	C	7	184.2-196.1	12.6	L	A	D	35	192.3-228.9	15.9	N	A	D	58
249.8-309.0	21.9	13.6	32.3	6.1	E	A	C	7	196.2-210.1	12.5	L	A	D	34	229.0-255.3	15.5	N	A	C	58
309.1-340.2	21.3	12.5	31.8	5.6	E	A	C	6	210.2-228.9	12.2	L	A	D	31	255.4-273.7	15.3	M	A	C	58
340.3-432.0	20.9	12.3	31.6	5.4	C	A	C	6	229.0-249.7	11.8	L	A	C	31	273.8-378.6	15.3	L	A	C	58
432.1-454.7	20.5	11.7	31.3	5.1	C	A	C	5	249.8-340.2	11.1	E	A	C	31	378.7-382.7	14.8	E	A	C	58
454.8-480.9	19.9	11.4	30.9	4.7	B	A	C	5	340.3-454.7	10.9	C	A	C	31	382.8-458.2	12.5	E	A	C	54
481.0-524.3	15.1	5.2	2.5	2.5	B	A	A	5	454.8-463.6	10.5	B	A	C	31	458.3-480.9	11.8	E	A	C	51
524.4-550.9	15.0	5.0	2.4	2.4	B	A	A	3	463.7-480.9	9.4	B	A	C	30	481.0-489.1	5.6	E	A	A	51
551.0-	14.8	4.7	2.3	2.3	B	A	A	1	481.0-498.6	4.8	B	A	A	30	489.2-494.5	5.4	C	A	A	51
									498.7-539.8	4.2	B	A	A	26	494.6-674.5	5.4	C	A	A	50
									539.9-	4.2	B	A	A	25	674.6-	5.2	B	A	A	50

Table A-24. 9000 kg- TNT High Level of Protection

STANDOFF DISTANCE IN METERS	% Increase				Construction Type				STANDOFF DISTANCE IN METERS	%Δ	Construction Type				STANDOFF DISTANCE IN METERS	%Δ	Construction Type			
	ADMIN FACILITY	MEDICAL CLINIC	BARRACKS (EXT ENT)	BARRACKS (INT ENT)	Walls	Windows	Doors	Roofs			DINING FACILITY	Walls	Windows	Doors			Roofs	SPECIAL STRUCTURE	Walls	Windows
73.9-88.3	60.7	35.5	74.2	20.0	W	H	H	24	73.9-88.3	29.6	W	H	H	48	83.6-88.3	35.5	W	H	H	72
88.4-90.7	59.4	33.9	66.8	19.4	W	H	G	24	88.4-90.7	28.5	W	H	G	48	88.4-90.7	33.9	W	H	G	72
90.8-93.6	57.8	33.6	66.6	19.1	W	G	G	24	90.8-93.6	28.2	W	G	G	48	90.8-93.6	33.6	W	G	G	72
93.7-103.1	56.7	31.8	65.8	18.4	W	G	G	21	93.7-103.1	26.9	W	G	G	45	93.7-120.7	31.8	W	G	G	69
103.2-112.0	55.8	31.3	65.2	17.8	V	G	G	21	103.2-112.0	26.3	V	G	G	45	120.8-127.5	31.3	V	G	G	69
112.1-127.5	55.1	31.0	64.7	17.3	T	G	G	21	112.1-127.5	25.8	T	G	G	45	127.6-131.5	28.1	V	G	F	69
127.6-139.8	52.5	27.7	49.9	16.1	T	G	F	21	127.6-139.8	23.4	T	G	F	45	131.6-139.8	27.7	T	G	F	69
139.9-141.8	39.1	25.4	47.6	13.8	T	F	F	21	139.9-141.8	21.3	T	F	F	45	139.9-141.8	25.4	T	F	F	69
141.9-171.1	38.4	24.6	43.9	13.5	T	F	E	21	141.9-147.7	20.7	T	F	E	45	141.9-147.7	24.6	T	F	E	69
171.2-177.5	37.8	24.3	43.5	13.1	S	F	E	21	147.8-171.1	20.1	T	F	E	44	147.8-177.5	23.7	T	F	E	68
177.6-190.7	37.5	23.9	41.4	13.0	S	F	D	21	171.2-177.5	19.7	S	F	E	44	177.6-190.7	23.3	T	F	D	68
190.8-194.8	35.9	23.6	41.2	12.7	S	E	D	21	177.6-190.7	19.3	S	F	D	44	190.8-195.9	23.0	T	E	D	68
194.9-195.9	33.2	22.4	39.4	11.0	P	E	D	21	190.8-194.8	19.1	S	E	D	44	196.0-208.2	22.6	T	D	D	68
196.0-213.8	31.2	22.0	39.1	10.6	P	D	D	21	194.9-195.9	17.3	P	E	D	44	196.0-213.8	22.3	S	D	D	68
213.9-227.3	30.4	20.7	38.5	10.1	P	D	D	19	196.0-213.8	17.0	P	D	D	44	213.9-227.3	22.0	S	D	D	67
227.4-261.6	27.7	16.4	36.6	8.3	P	D	D	12	213.9-261.6	16.7	P	D	D	43	227.4-237.0	18.4	S	D	D	60
261.7-265.3	27.3	15.9	34.4	8.1	P	D	C	12	261.7-265.3	16.4	P	D	C	43	237.1-261.6	17.2	P	D	D	60
265.4-314.2	27.0	15.8	34.2	7.9	O	D	C	12	265.4-279.1	16.2	O	D	C	43	261.7-279.5	16.7	P	D	C	60
314.3-319.9	26.4	14.8	33.8	7.5	O	D	C	7	279.2-319.9	13.2	O	D	C	36	279.6-292.7	16.3	P	D	C	59
320.0-323.0	23.9	14.4	33.3	7.1	O	C	C	7	320.0-323.0	12.8	O	C	C	36	292.8-319.9	16.2	P	D	C	58
323.1-327.1	23.8	14.3	33.3	7.1	N	C	C	7	323.1-327.1	12.8	N	C	C	36	320.0-372.7	15.7	P	C	C	58
327.2-372.7	23.4	14.1	33.0	6.8	L	C	C	7	327.2-356.1	12.5	L	C	C	36	372.8-384.6	15.7	P	B	C	58
372.8-424.8	23.4	14.1	33.0	6.8	L	B	C	7	356.2-372.7	12.4	L	C	C	35	384.7-401.3	15.6	O	B	C	58
424.9-441.6	22.9	14.0	32.9	6.7	L	A	C	7	372.8-386.0	12.4	L	B	C	35	401.4-424.8	15.5	N	B	C	58

Table A-24 (continued). 9000 kg- TNT High Level of Protection

STANDOFF DISTANCE IN METERS	% Increase				Construction Type				STANDOFF DISTANCE IN METERS	%Δ	Construction Type				STANDOFF DISTANCE IN METERS	%Δ	Construction Type			
	ADMIN FACILITY	MEDICAL CLINIC	BARRACKS (EXT ENT)	BARRACKS (INT ENT)	Walls	Windows	Doors	Roofs			DINING FACILITY	Walls	Windows	Doors			Roofs	SPECIAL STRUCTURE	Walls	Windows
441.7-520.2	21.9	13.6	32.3	6.1	E	A	C	7	386.1-412.8	12.2	L	B	C	34	424.9-488.6	15.5	N	A	C	58
520.3-520.6	21.3	12.5	31.8	5.6	E	A	C	6	412.9-424.8	11.9	L	B	C	31	488.7-647.3	15.3	L	A	C	58
520.7-713.3	20.9	12.3	31.6	5.4	D	A	C	6	424.9-441.6	11.8	L	A	C	31	647.4-679.0	14.8	E	A	C	58
713.4-844.3	20.5	11.7	31.3	5.1	D	A	C	5	441.7-520.6	11.1	E	A	C	31	679.1-742.7	12.5	E	A	C	54
844.4-914.6	20.4	11.5	31.2	5.0	D	A	C	3	520.7-799.7	10.9	D	A	C	31	742.8-794.1	12.4	D	A	C	54
914.7-1024.9	20.2	11.2	31.1	4.9	D	A	C	1	799.8-851.0	9.8	D	A	C	30	794.2-864.7	11.7	D	A	C	51
1025.0-	15.4	5.0	2.6	2.7	D	A	A	1	851.1-899.5	9.2	D	A	C	26	864.8-1024.9	11.6	D	A	C	50
									899.6-1024.9	9.1	D	A	C	25	1025.0-	5.4	D	A	A	50
									1025.0-	4.5	D	A	A	25						

**Table A-25. Building Cost Increases Hand Delivered Devices
Low Threat Severity Level
(IID only)**

Building Type	Very Low & Low LOP				Medium LOP				High LOP						
	% Increase	Walls	Windows	Doors	Roof	% Increase	Walls	Windows	Doors	Roof	% Increase	Walls	Windows	Doors	Roof
Administrative Facility	9.5					9.5					9.5				
Medical Clinic	1.7					1.7					1.7				
Barracks with Exterior Entries	1.7	A	A	A	A	1.7	A	A	A	A	1.7	A	A	A	A
Barracks with Interior Entries	1.7					1.7									
Dining Facility	1.2					1.2									
Special Structure	1.7					1.7									

**Table A-26. Building Cost Increases Hand Delivered Devices
Medium Threat Severity Level
(Hand grenades and 1 kg IED only)**

Building Type	Very Low and Low LOP				Medium LOP				High LOP						
	% Increase	Walls	Windows	Doors	Roof	% Increase	Walls	Windows	Doors	Roof	% Increase	Walls	Windows	Doors	Roof
Administrative Facility	9.5					9.5					41.7				
Medical Clinic	1.7					1.7					17.0				
Barracks with Exterior Entries	1.7	A	A	A	A	1.7	A	A	A	A	14.4	C	B	A	B
Barracks with Interior Entries	1.7					1.7					10.0				
Dining Facility	1.2					1.2					14.1				
Special Structure	1.7					1.7					17.0				

Table A-27. Cost Increases for Mail rooms 1 kg TNT Explosive						
Building Type	Low Level of Protection		Medium Level of Protection		High Level of Protection	
	% Cost Increase	Construction	% Cost Increase	Construction	% Cost Increase	Construction
Dining Facility • Small ¹ • Medium ² • Large ³	0.8 1.0 1.3	See Table C-6	0.9 1.0 1.3	See Table C-6	0.9 1.1 1.4	See Table C-6
Administration Building • Small ¹ • Medium ² • Large ³	0.8 1.0 1.3		0.8 1.0 1.3		0.9 1.1 1.4	
Medical Clinic • Small ¹ • Medium ² • Large ³	0.5 0.6 0.7		0.5 0.6 0.7		0.5 0.6 0.8	
Barracks with Exterior Entrances • Small ¹ • Medium ² • Large ³	0.2 0.2 0.3		0.2 0.2 0.3		0.2 0.3 0.3	
Barracks with Interior Entrances • Small ¹ • Medium ² • Large ³	0.2 0.3 0.3		0.2 0.3 0.3		0.2 0.3 0.3	
Special Structures • Small ¹ • Medium ² • Large ³	0.6 0.7 0.9		0.6 0.7 0.9		0.6 0.7 1.0	
1. 10 ft. x 20 ft. x 10 ft. 2. 16 ft. x 25 ft. x 10 ft. 3. 22 ft. x 32 ft. x 10 ft.						

Table A-28. Cost Increases for Loading Docks 1 kg TNT Explosive							
Building Type	Low Level of Protection		Medium Level of Protection		High Level of Protection		
	% Cost Increase	Construction	% Cost Increase	Construction	% Cost Increase	Construction	
Dining Facility							
• Small ¹	0.8	See Table C-6	0.9	See Table C-6	0.9	See Table C-6	
• Medium ²	1.1		1.1		1.2		
• Large ³	1.4		1.4		1.6		
Administration Building							
• Small ¹	0.8		0.9		0.9		
• Medium ²	1.1		1.1		1.2		
• Large ³	1.4		1.4		1.6		
Medical Clinic							
• Small ¹	0.5	0.5	0.5				
• Medium ²	0.6	0.6	0.6				
• Large ³	0.8	0.8	0.9				
Barracks with Exterior Entrances							
• Small ¹	0.2	0.2	0.2				
• Medium ²	0.3	0.3	0.3				
• Large ³	0.3	0.3	0.4				
Barracks with Interior Entrances							
• Small ¹	0.2	0.2	0.2				
• Medium ²	0.3	0.3	0.3				
• Large ³	0.3	0.3	0.4				
Special Structures							
• Small ¹	0.6	0.6	0.6				
• Medium ²	0.7	0.8	0.8				
• Large ³	0.9	1.0	1.1				

1. 10 ft. x 22 ft. x 10 ft.
2. 16 ft. x 34 ft. x 10 ft.
3. 22 ft. x 46 ft. x 10 ft.

Table A-29. Cost Increases for Loading Docks 25 kg TNT Explosive						
Building Type	Low Level of Protection		Medium Level of Protection		High Level of Protection	
	% Cost Increase	Construction	% Cost Increase	Construction	% Cost Increase	Construction
Dining Facility • Small ¹ • Medium ² • Large ³	1.4 2.0 2.9	See Table C-7	1.5 2.1 3.0	See Table C-7	1.6 2.3 3.3	See Table C-7
Administration Building • Small ¹ • Medium ² • Large ³	1.4 2.0 2.8		1.5 2.1 3.0		1.6 2.3 3.3	
Medical Clinic • Small ¹ • Medium ² • Large ³	0.8 1.1 1.5		0.8 1.2 1.6		0.9 1.2 1.8	
Barracks with Exterior Entrances • Small ¹ • Medium ² • Large ³	0.3 0.5 0.7		0.4 0.5 0.7		0.4 0.5 0.8	
Barracks with Interior Entrances • Small ¹ • Medium ² • Large ³	0.4 0.5 0.7		0.4 0.5 0.7		0.4 0.6 0.8	
Special Structures • Small ¹ • Medium ² • Large ³	1.0 1.4 1.9		1.1 1.5 2.1		1.1 1.6 2.3	
1. 10 ft. x 22 ft. x 10 ft. 2. 16 ft. x 34 ft. x 10 ft. 3. 22 ft. x 46 ft. x 10 ft.						

Table A-30. Cost Increases for Entry Areas 1 kg TNT Explosive							
Building Type	Low Level of Protection		Medium Level of Protection		High Level of Protection		
	% Cost Increase	Construction	% Cost Increase	Construction	% Cost Increase	Construction	
Dining Facility							
• Small ¹	1.0	See Table C-6	1.0	See Table C-6	1.1	See Table C-6	
• Medium ²	1.3		1.3		1.4		
• Large ³	2.0		2.0		2.0		
Administration Building							
• Small ¹	1.0		1.0		1.1		
• Medium ²	1.2		1.3		1.4		
• Large ³	2.0		2.0		2.0		
Medical Clinic							
• Small ¹	0.6	0.6	0.6				
• Medium ²	0.7	0.7	0.7				
• Large ³	1.1	1.1	1.1				
Barracks with Exterior Entrances							
• Small ¹	0.2	0.2	0.3				
• Medium ²	0.3	0.3	0.3				
• Large ³	0.5	0.5	0.5				
Barracks with Interior Entrances							
• Small ¹	0.3	0.3	0.3				
• Medium ²	0.3	0.3	0.3				
• Large ³	0.5	0.5	0.5				
Special Structures							
• Small ¹	0.7	0.7	0.7				
• Medium ²	0.9	0.9	0.9				
• Large ³	1.4	1.4	1.4				

1. 15 ft. x 30 ft. x 10 ft.
2. 20 ft. x 40 ft. x 10 ft.
3. 40 ft. x 50 ft. x 10 ft.

Table A-31. Cost Increases for Entry Areas 25 kg TNT Explosive						
Building Type	Low Level of Protection		Medium Level of Protection		High Level of Protection	
	% Cost Increase	Construction	% Cost Increase	Construction	% Cost Increase	Construction
Dining Facility • Small ¹ • Medium ² • Large ³	1.6 2.2 4.1	See Table C-6	1.7 2.4 4.5	See Table C-6	1.9 2.5 4.9	See Table C-6
Administration Building • Small ¹ • Medium ² • Large ³	1.6 2.2 4.0		1.7 2.3 4.5		1.8 2.5 4.8	
Medical Clinic • Small ¹ • Medium ² • Large ³	0.9 1.2 2.2		0.9 1.3 2.5		1.0 1.4 2.6	
Barracks with Exterior Entrances • Small ¹ • Medium ² • Large ³	0.4 0.5 1.0		0.4 0.6 1.1		0.4 0.6 1.1	
Barracks with Interior Entrances • Small ¹ • Medium ² • Large ³	0.4 0.5 1.0		0.4 0.6 1.1		0.5 0.6 1.2	
Special Structures • Small ¹ • Medium ² • Large ³	1.1 1.5 2.8		1.2 1.6 3.1		1.3 1.7 3.3	
1. 15 ft. x 30 ft. x 10 ft. 2. 20 ft. x 40 ft. x 10 ft. 3. 40 ft. x 50 ft. x 10 ft.						

**Table A-32. Building Cost Increases for Indirect Fire Weapons
Low Threat Severity Level**

Building Type	Low LOP				Medium LOP				High LOP						
	% Increase	Walls	Windows	Doors	Roof	% Increase	Walls	Windows	Doors	Roof	% Increase	Walls	Windows	Doors	Roof
Dining Facility	1.2					1.2					1.2				
Administrative Facility	9.5					9.5					9.5				
Medical Clinic	1.8					1.8					1.8				
Barracks with Exterior Entrances	1.7	cc	A	cc	cc	1.7	cc	A	cc	cc	1.7	cc	A	cc	cc
Barracks with Interior Entrances	1.7					1.7					1.7				
Special Structure	1.8					1.8					1.8				
cc = conventional construction. The baseline construction for those components is adequate															

Table A-33. Building Cost Increases for Indirect Fire Weapons Medium Threat Severity Level																					
Building Type	Low LOP							Medium LOP							High LOP						
	% Increase	Walls	Wall Extensions	Windows	Doors	Hardened Roof	Sacrificial Roof	% Increase	Walls	Wall Extensions	Windows	Doors	Hardened Roof	Sacrificial Roof	% Increase	Walls	Wall Extensions	Windows*	Doors	Hardened Roof	Sacrificial Roof
Dining Facility	8.2	A	A	A	A	2	3	16.5	B	B	A	A	3	3	22.3	F	C	C	A	8	3
Administrative Facility	15.5	A	A	A	A	2	3	25.4	B	B	A	A	3	3	24.6	F	C	C	A	8	3
Medical Clinic	10.2	A	A	A	A	2	1	17.6	B	B	A	A	3	1	22.4	F	C	C	A	8	1
Barracks with Exterior Entrances	14.3	B	B	A	A	2	3	14.6	B	B	A	A	3	3	25.2	F	C	C	A	8	3
Barracks with Interior Entrances	7.6	B	B	A	A	2	3	7.9	B	B	A	A	3	3	12.2	F	C	C	A	8	3
Special Structure	18.3	B	B	A	A	2	3	19.0	B	B	A	A	3		22.9	F	C	C	A	8	3
*Note: Windows are not feasible at this LOP due to weapon casing fragments																					

**Table A-34. Building Cost Increases for Indirect Fire Weapons
High Threat Severity Level**

Building Type	Low LOP							Medium LOP							High LOP						
	% Increase	Walls	Wall Extensions	Windows	Doors	Hardened Roof	Sacrificial Roof	% Increase	Walls	Wall Extensions	Windows	Doors	Hardened Roof	Sacrificial Roof	% Increase	Walls	Wall Extensions	Windows*	Doors	Hardened Roof	Sacrificial Roof
Dining Facility	16.7	B	B	A	A	7	3	22.0	E	C	A	A	8	3	37.2	H	C	C	A	9	4
Administrative Facility	25.6	B	B	A	A	7	3	32.6	E	C	A	A	8	3	44.4	H	C	C	A	9	4
Medical Clinic	18.0	B	B	A	A	7	1	22.5	E	C	A	A	8	1	35.7	H	C	C	A	9	2
Barracks with Exterior Entrances	14.8	B	B	A	A	7	3	23.4	E	C	A	A	8	3	46.5	H	C	C	A	9	4
Barracks with Interior Entrances	8.0	B	B	A	A	7	3	12.3	E	C	A	A	8	3	23.0	H	C	C	A	9	4
Special Structure	19.3	B	B	A	A	7	3	23.2	E	C	A	A	8	3	34.1	H	C	C	A	9	4
*Note: Windows are not feasible at this LOP due to weapon casing fragments																					

**Table A-35. Building Cost Increases for Indirect Fire Weapons
Very High Threat Severity Level**

Building Type	Low LOP							Medium LOP							High LOP							
	% Increase	Walls	Wall Extensions	Windows	Doors	Hardened Roof	Sacrificial Roof	% Increase	Walls	Wall Extensions	Windows*	Doors	Hardened Roof	Sacrificial Roof	% Increase	Walls	Wall Extensions	Windows	Doors	Hardened Roof	Sacrificial Roof	
Dining Facility	25.7	E	C	B	A	5	4	28.2	G	C	C	A	11	4		<i>Designing to meet this level of protection for this threat is not practical for conventional buildings</i>						
Administrative Facility	37.2	E	C	B	A	5	4	28.6	G	C	C	A	11	4								
Medical Clinic	25.7	E	C	B	A	5	2	28.6	G	C	C	A	11	2								
Barracks with Exterior Entrances	25.8	E	C	B	A	5	4	29.1	G	C	C	A	11	4								
Barracks with Interior Entrances	13.6	E	C	B	A	5	4	14.6	G	C	C	A	11	4								
Special Structure	25.3	E	C	B	A	5	4	28.0	G	C	C	A	11	4								
*Note: Windows are not feasible at this LOP due to weapon casing fragments																						

Table A-36. Building Cost Increases for Direct Fire Weapons Low Threat Severity Level																
Building Type	Low LOP				High LOP											
	% Increase	Walls	Windows	Doors	Roof	% Increase¹	Walls	Windows	Doors	Roof²						
Dining Facility	0.22	A	A	A	A	4.0	B	C	B	A						
						5.0				C						
Administration Building	1.43											23.2				A
						23.9				B						
Medical Clinic	0.23											4.4				A
						7.2				B						
Barracks with Exterior Entrances	0.24											9.9				A
						10.4				B						
						4.3				A						
Barracks with Interior Entrances	0.24											4.8				B
						7.5				A						
Special Structures	0.37											10.8				D

Note: Costs are for entire building exterior. For smaller portions of buildings use a straight percentage of protected perimeter ÷ total perimeter

1. For roofs to which there is no sightline, use top number in each pair of values for % cost increase. Where there is a sightline to a roof, use bottom number in each pair of values for % cost increase.

2. For roofs to which there is no sightline, the top roof designation in each pair indicates the roof construction on which the cost increase is based. The bottom roof designation in each pair indicates the roof construction on which the cost increase is based where there is a sightline to the roof.

Table A-37. Building Cost Increases for Direct Fire Weapons Medium Threat Severity Level										
Building Type	Low LOP				High LOP					
	% Increase	Walls	Windows	Doors	Roof	% Increase¹	Walls	Windows	Doors	Roof²
Dining Facility	0.22	A	A	A	A	7.8	C	D	C	A
						8.8				C
Administration Building	1.43					29.2				A
						29.7				B
Medical Clinic	0.23					7.2				A
						10.0				B
Barracks with Exterior Entrances	0.24					12.3				A
						12.8				B
Barracks with Interior Entrances	0.24					4.8				A
						5.3				B
Special Structures	0.37					8.2				A
						11.5				D

Note: Costs are for entire building exterior. For smaller portions of buildings use a straight percentage of protected perimeter ÷ total perimeter

1. For roofs to which there is no sightline, use top number in each pair of values for % cost increase. Where there is a sightline to a roof, use bottom number in each pair of values for % cost increase.
2. For roofs to which there is no sightline, the top roof designation in each pair indicates the roof construction on which the cost increase is based. The bottom roof designation in each pair indicates the roof construction on which the cost increase is based where there is a sightline to the roof.

Table A-38. Building Cost Increases for Direct Fire Weapons High Threat Severity Level																
Building Type	Low LOP				High LOP											
	% Increase	Walls	Windows	Doors	Roof	% Increase ¹	Walls	Windows	Doors	Roof ²						
Dining Facility	0.22	A	A	A	A	9.7	D	E	D	A						
						15.3				E						
Administration Building	1.43											37.7				A
						41.1				E						
Medical Clinic	0.23											9.1				A
						17.2				E						
Barracks with Exterior Entrances	0.24											15.3				A
						18.0				E						
Barracks with Interior Entrances	0.24											6.8				A
						9.7				E						
Special Structures	0.37				10.4				A							
		18.5	E													

Note: Costs are for entire building exterior. For smaller portions of buildings use a straight percentage of protected perimeter ÷ total perimeter

1. For roofs to which there is no sightline, use top number in each pair of values for % cost increase. Where there is a sightline to a roof, use bottom number in each pair of values for % cost increase.
2. For roofs to which there is no sightline, the top roof designation in each pair indicates the roof construction on which the cost increase is based. The bottom roof designation in each pair indicates the roof construction on which the cost increase is based where there is a sightline to the roof.

Table A-39. Building Cost Increases for Direct Fire Weapons Very High Threat Severity Level														
Building Type	Low LOP				Medium and High LOP									
	% Increase	Walls	Windows	Doors	Roof	% Increase¹	Walls	Windows	Doors	Roof²				
Dining Facility	0.22	A	A	A	A	13.0	E	None	E	A				
												19.6		F
Administration Building	1.43											19.0		A
												24.8		F
Medical Clinic	0.23											12.5		A
												24.2		F
Barracks with Exterior Entrances	0.24											33.5		A
												37.4		F
Barracks with Interior Entrances	0.24											15.0		A
												19.3		F
Special Structures	0.37											14.6		A
												26.3		F

Note: Costs are for entire building exterior. For smaller portions of buildings use a straight percentage of protected perimeter ÷ total perimeter

1. For roofs to which there is no sightline, use top number in each pair of values for % cost increase. Where there is a sightline to a roof, use bottom number in each pair of values for % cost increase.
2. For roofs to which there is no sightline, the top roof designation in each pair indicates the roof construction on which the cost increase is based. The bottom roof designation in each pair indicates the roof construction on which the cost increase is based where there is a sightline to the roof.

Table A-40. Building Cost Increases for Airborne Contamination Mitigation (All Threat Severity Levels and Levels of Protection)						
Building Type	Low LOP		Medium LOP		High LOP	
	% Increase	HVAC Requirements	% Increase	HVAC Requirements	% Increase	HVAC Requirements
Dining Facility	1.0	See Table C-12	17.2	See Table C-12	27.9	See Table C-12
Administrative Facility	0.4		6.3		13.9	
Medical Clinic	0.7		11.8		18.5	
Barracks with Exterior Entrances	0.4		11.1		13.9	
Barracks with Interior Entrances	0.1		6.7		7.8	
Special Structure	1.0		33.0		46.4	

Table A-41. Costs to Mitigate Waterborne Contamination (All Building Types, Threat Severity Levels and Levels of Protection)						
Building Type	Level of Protection					
	Low LOP		Medium LOP		High LOP	
	%	O & M / year	%	O & M / year	%	O & M / year
Administrative Facility	0.4	0	6.1	\$30,000	10.5	\$30,000
Medical Clinic	0.1	0	2.5	\$30,000	4.3	\$30,000
Barracks with Exterior Entries	0.1	0	1.6	\$30,000	2.8	\$30,000
Barracks with Interior Entries	0.1	0	1.4	\$30,000	2.5	\$30,000
Dining Facility	0.5	0	7.9	\$30,000	13.6	\$30,000
Special Structure	0.3	0	5.7	\$30,000	9.9	\$30,000

Table A-42. Building Cost Increases for Forced Entry Tactic Low Threat Severity Level																				
Building Type	Low LOP				Medium LOP				High LOP				Very High LOP							
	% Increase	Walls	Windows	Doors	Roof	% Increase	Walls	Windows	Doors	Roof	% Increase	Walls	Windows	Doors	Roof	% Increase	Walls	Windows	Doors	Roof
Administrative Facility	8.2					10.6					19.1					5.6				
Medical Clinic	0.0					0.3					12.7					12.5				
Barracks with Exterior Entries	1.3	A	A	A	A	2.8	B	B	A	A	10.2	D	B	D	D	9.9	F	No*	E	F
Barracks with Interior Entries	0.9					2.4					8.0					7.1				
Dining Facility	0.0					0.0					8.1					7.9				
Special Structure	0.0					4.4					17.6					18.8				
* Note: Windows are not available to meet this requirement. Eliminate or limit openings to 96 square inches.																				

**Table A-43. Building Cost Increases for Forced Entry Tactic
Medium Threat Severity Level**

Building Type	Low LOP				Medium LOP				High LOP				Very High LOP							
	% Increase	Walls	Windows	Doors	Roof	% Increase	Walls	Windows	Doors	Roof	% Increase	Walls	Windows	Doors	Roof	% Increase	Walls	Windows	Doors	Roof
Administrative Facility	11.6	A	A	A	A	19.6	C	B	B	G	4.7	E	No*	H	E	11.3	L	No*	F	J
Medical Clinic	4.8					14.0					11.6					17.6				
Barracks with Exterior Entries	3.8					9.1					13.4					17.1				
Barracks with Interior Entries	3.2					8.3					6.4					10.4				
Dining Facility	1.4					8.8					7.4					12.6				
Special Structure	4.3					17.6					17.4					28.5				

* Note: Windows are not available to meet this requirement. Eliminate or limit openings to 96 square inches.

Table A-44. Building Cost Increases for Forced Entry Tactic High Threat Severity Level																				
Building Type	Low LOP				Medium LOP				High LOP				Very High LOP							
	% Increase	Walls	Windows	Doors	Roof	% Increase	Walls	Windows	Doors	Roof	% Increase	Walls	Windows	Doors	Roof	% Increase	Walls	Windows	Doors	Roof
Administrative Facility	11.6					22.2					7.7					17.2				
Medical Clinic	4.8					15.7					14.3					23.2				
Barracks with Exterior Entries	3.8	A	A	A	A	12.4	G	B	C	H	15.5	H	No*	I	I	22.6	J	No*	J	J
Barracks with Interior Entries	3.2					10.1					8.2					13.9				
Dining Facility	1.4					10.8					9.8					17.5				
Special Structure	4.3					23.4					22.4					38.4				

* Note: Windows are not available to meet this requirement. Eliminate or limit openings to 96 square inches.

Table A-45. Building Cost Increases for Forced Entry Tactic Very High Threat Severity Level																				
Building Type	Low LOP				Medium LOP				High LOP				Very High LOP							
	% Increase	Walls	Windows	Doors	Roof	% Increase	Walls	Windows	Doors	Roof	% Increase	Walls	Windows	Doors	Roof	% Increase	Walls	Windows	Doors	Roof
Administrative Facility	12.8					24.9					28.9					50.4				
Medical Clinic	5.3					25.3					31.7					46.9				
Barracks with Exterior Entries	3.8	C	No*	A	C	25.0	K	No*	G	K	29.7	L	No*	J	M	47.9	M	No*	K	N
Barracks with Interior Entries	3.2					18.2					20.1					33.2				
Dining Facility	2.1					21.1					25.7					40.9				
Special Structure	8.3					53.3					59.0					97.0				
* Note: Windows are not available to meet this requirement. Eliminate or limit openings to 96 square inches.																				

**Table A-46. Interior Area Cost Increases for Forced Entry Tactic
Low Threat Severity Level**

Building Type	Low LOP				Medium LOP				High LOP				Very High LOP								
	% Increase	Walls	Windows	Doors	Roof	% Increase	Walls	Windows	Doors	Roof	% Increase	Walls	Windows	Doors	Roof	% Increase	Walls	Windows	Doors	Roof	
Administrative Facility • Small ¹ • Medium ² • Large ³	0.04	A	None ⁴	A	A	0.12	C	None ⁴	A	D	0.25	D	None ⁴	I	G	0.32	II	None ⁴	III	II	II
	0.06					0.18					0.41					0.51					
	0.07					0.21					0.52					0.65					
Medical Clinic • Small ¹ • Medium ² • Large ³	0.02	A	None ⁴	A	A	0.06	C	None ⁴	A	D	0.14	D	None ⁴	I	G	0.18	II	None ⁴	III	II	II
	0.03					0.10					0.22					0.28					
	0.04					0.11					0.29					0.36					
Barracks with Exterior Entries • Small ¹ • Medium ² • Large ³	0.01	A	None ⁴	A	A	0.03	C	None ⁴	A	D	0.06	D	None ⁴	I	G	0.08	II	None ⁴	III	II	II
	0.01					0.04					0.10					0.12					
	0.02					0.05					0.12					0.15					

Table A-46 - continued

Barracks with Interior Entries																				
• Small ¹	0.01					0.03					0.06					0.08				
• Medium ²	0.02					0.05					0.10					0.13				
• Large ³	0.02					0.05					0.13					0.17				
Dining Facility		A	None ⁴	A	A		C	None ⁴	A	D		D	None ⁴	H	G		E	None ⁴	E	F
• Small ¹	0.04					0.12					0.26					0.33				
• Medium ²	0.06					0.18					0.41					0.52				
• Large ³	0.07					0.21					0.53					0.66				
Special Structure																				
• Small ¹	0.03					0.08					0.18					0.22				
• Medium ²	0.04					0.12					0.28					0.35				
• Large ³	0.05					0.14					0.36					0.45				

Notes:

1. Room size: 12 ft. x 12 ft. x 10 ft. high
2. Room size: 12 ft. x 24 ft. x 10 ft. high
3. Room size: 18 ft. x 24 ft. x 10 ft. high
4. Windows are not included because areas are interior spaces.

A-60

A-61

Table A-47. Interior Area Cost Increases for Forced Entry Tactic Medium Threat Severity Level																																				
Building Type	Low LOP				Medium LOP				High LOP				Very High LOP																							
	% Increase	Walls	Windows	Doors	Roof	% Increase	Walls	Windows	Doors	Roof	% Increase	Walls	Windows	Doors	Roof	% Increase	Walls	Windows	Doors	Roof																
Administrative Facility • Small ¹ • Medium ² • Large ³	0.08	A	None ⁴	A	A	0.23	C	None ⁴	B	G	0.36	E	None ⁴	H	E	0.48	L	None ⁴	F	J																
	0.13					0.39					0.53					0.73																				
	0.18					0.51					0.65					0.90																				
Medical Clinic • Small ¹ • Medium ² • Large ³	0.04																					0.13					0.20					0.26				
	0.07																					0.21					0.29					0.40				
	0.10																					0.28					0.36					0.49				
Barracks with Exterior Entries • Small ¹ • Medium ² • Large ³	0.02																					0.05					0.08					0.11				
	0.03																					0.09					0.12					0.17				
	0.04																					0.12					0.15					0.21				

Table A-47 - continued

Barracks with Interior Entries																				
• Small ¹	0.02					0.06														
• Medium ²	0.03					0.10														
• Large ³	0.05					0.13														
Dining Facility																				
• Small ¹	0.08	A	None ⁴	A	A	0.23	C	None ⁴	B	G	0.36	E	None ⁴	H	E	0.48	L	None ⁴	F	J
• Medium ²	0.14					0.39					0.54					0.73				
• Large ³	0.18					0.51					0.66					0.91				
Special Structure																				
• Small ¹	0.05					0.16					0.25					0.33				
• Medium ²	0.09					0.27					0.37					0.50				
• Large ³	0.12					0.35					0.45					0.62				

Notes:

1. Room size: 12 ft. x 12 ft. x 10 ft. high
2. Room size: 12 ft. x 24 ft. x 10 ft. high
3. Room size: 18 ft. x 24 ft. x 10 ft. high
4. Windows are not included because areas are interior spaces.

Table A-48. Interior Area Cost Increases for Forced Entry Tactic High Threat Severity Level																				
Building Type	Low LOP				Medium LOP				High LOP				Very High LOP							
	% Increase	Walls	Windows	Doors	Roof	% Increase	Walls	Windows	Doors	Roof	% Increase	Walls	Windows	Doors	Roof	% Increase	Walls	Windows	Doors	Roof
Administrative Facility • Small ¹ • Medium ² • Large ³	0.2	A	None ⁴	A	A	0.6	G	None ⁴	C	H	0.9	H	None ⁴	I	I	1.1	H	None ⁴	J	J
	0.4					1.0					1.4					1.8				
	0.6					1.4					1.9					2.3				
Medical Clinic • Small ¹ • Medium ² • Large ³	0.1	A	None ⁴	A	A	0.3	G	None ⁴	C	H	0.5	H	None ⁴	I	I	0.6	H	None ⁴	J	J
	0.2					0.6					0.8					1.0				
	0.3					0.7					1.0					1.3				
Barracks with Exterior Entries • Small ¹ • Medium ² • Large ³	0.1	A	None ⁴	A	A	0.1	G	None ⁴	C	H	0.2	H	None ⁴	I	I	0.3	H	None ⁴	J	J
	0.1					0.2					0.3					0.4				
	0.1					0.3					0.4					0.5				

Table A-48 - continued

Barracks with Interior Entries																				
• Small ¹	0.1					0.2				0.2					0.3					
• Medium ²	0.1					0.3				0.4					0.5					
• Large ³	0.2					0.3				0.5					0.6					
Dining Facility																				
• Small ¹	0.2	A	None ⁴	A	A	0.6	G	None ⁴	C	H	0.9	H	None ⁴	I	I	1.1	H	None ⁴	J	J
• Medium ²	0.4					1.0					4.5					1.8				
• Large ³	0.6					1.4					1.9					2.3				
Special Structure																				
• Small ¹	0.2					0.4					0.6					0.8				
• Medium ²	0.3					0.7					1.0					1.2				
• Large ³	0.4					0.9					1.3					1.6				
Notes:																				
1. Room size: 12 ft. x 12 ft. x 10 ft. high																				
2. Room size: 12 ft. x 24 ft. x 10 ft. high																				
3. Room size: 18 ft. x 24 ft. x 10 ft. high																				
4. Windows are not included because areas are interior spaces.																				

A-64

Table A-49. Building Cost Increases for Covert Entry Tactic
Low Threat Severity Level

Building Type	Low Level of Protection		Medium Level of Protection		High Level of Protection		Very High Level of Protection	
	% Cost Increase	Equip. Set	% Cost Increase	Equip. Set	% Cost Increase	Equip. Set	% Cost Increase	Equip. Set
Dining Facility	0.11	B	0.74	C	1.25	D	1.95	E
Admin. Building	0.08	B	0.15	C	0.97	D	1.51	E
Medical Clinic	0.03	B	0.23	C	0.39	D	0.61	E
Barracks with Exterior Entrances	.02	B and A	.015	C and A	.026	D and A	0.40	E and A
Barracks with Interior Entrances	0.02	B and A	0.14	C and A	0.23	D and A	0.36	E and A
Special Structures	0.08	B	0.54	C	0.91	D	1.42	E

Table A-50 Building Cost Increases for Covert Entry Tactic
Medium Threat Severity Level

Building Type	Low Level of Protection		Medium Level of Protection		High Level of Protection		Very High Level of Protection	
	% Cost Increase	Equip. Set	% Cost Increase	Equip. Set	% Cost Increase	Equip. Set	% Cost Increase	Equip. Set
Dining Facility	0.67	F	0.83	G	1.33	H	1.95	I
Admin. Building	0.52	F	0.64	G	1.03	H	1.51	I
Medical Clinic	0.21	F	0.26	G	0.42	H	0.61	I
Barracks with Exterior Entrances	0.14	F and A	0.17	G and A	0.28	H and A	0.40	I and A
Barracks with Interior Entrances	0.12	F and A	0.15	G and A	0.24	H and A	0.36	I and A
Special Structures	0.46	F	0.61	G	0.97	H	1.42	I

Table A-51 Building Cost Increases for Covert Entry Tactic High Threat Severity Level								
Building Type	Low Level of Protection		Medium Level of Protection		High Level of Protection		Very High Level of Protection	
	% Cost Increase	Equip. Set	% Cost Increase	Equip. Set	% Cost Increase	Equip. Set	% Cost Increase	Equip. Set
Dining Facility	1.0	J	1.16	K	5.08	L	5.85	M
Admin. Building	0.77	J	0.9	K	3.93	L	4.52	M
Medical Clinic	0.31	J	0.36	K	1.59	L	1.83	M
Barracks with Exterior Entrances	0.21	J and A	0.24	K and A	1.05	L and A	1.21	M and A
Barracks with Interior Entrances	0.18	J and A	0.21	K and A	0.93	L and A	1.07	M and A
Special Structures	0.73	J	0.85	K	3.70	L	4.27	M

Table A-52 Building Cost Increases for Covert Entry Tactic Very High Threat Severity Level								
Building Type	Low Level of Protection		Medium Level of Protection		High Level of Protection		Very High Level of Protection	
	% Cost Increase	Equip. Set	% Cost Increase	Equip. Set	% Cost Increase	Equip. Set	% Cost Increase	Equip. Set
Dining Facility	1.0	J	1.16	K	5.08	L	5.85	M
Admin. Building	0.77	J	0.9	K	3.93	L	4.52	M
Medical Clinic	0.31	J	0.36	K	1.59	L	1.83	M
Barracks with Exterior Entrances	0.21	J and A	0.24	K and A	1.05	L and A	1.21	M and A
Barracks with Interior Entrances	0.18	J and A	0.21	K and A	0.93	L and A	1.07	M and A
Special Structures	0.73	J	0.85	K	3.70	L	4.27	M

Table A-53. Surveillance Tactic Cost Increases		
Building Type	% Cost Increase	Construction
Dining Facility	0.3%	0.10 mm (4-mil) reflective fragment retention film on windows
Administration Building	1.4%	
Medical Clinic	0.2%	
Barracks with Exterior Entrances	0.2%	
Barracks with Interior Entrances	0.2%	
Special Structures	0.3%	

Table A-54. Building Cost increases for Acoustics Eavesdropping Tactic

Building Type	Low LOP				Medium LOP				High LOP				Very High LOP							
	% Increase	Walls	Windows	Doors	Roof	% Increase	Walls	Windows	Doors	Roof	% Increase	Walls	Windows	Doors	Roof	% Increase	Walls	Windows	Doors	Roof
Dining Facility	0					0.8					1.3					2.5				
Administrative Facility	0					2.5					3.8					7.3				
Medical Clinic	0					0.9					1.5					2.6				
Barracks with Exterior Entries	0	A	A	A	A	5.8	A	B	B	A	7.9	A	C	C	A	11.4	A	D	D	A
Barracks with Interior Entries	0					0.6					1.0					1.7				
Special Structure	0					0.9					1.5					2.6				

Table A-55. Interior Area Cost Increases for Acoustics Eavesdropping Tactic

Building Type	Low LOP (STC 30)				Medium LOP (STC 40)				High LOP (STC 45)				Very High LOP (STC 50)								
	% Increase	Walls	Windows	Doors	Ceiling	% Increase	Walls	Windows	Doors	Ceiling	% Increase	Walls	Windows	Doors	Ceiling	% Increase	Walls	Windows	Doors	Ceiling	
1 story building • Small ¹ • Medium ² • Large ³	0.04	A	None	A	B	A	None	B	C	0.33 0.38 0.42	B	None	C	D	0.44 0.51 0.57	C	None	D	E		
	0.08				A															A	A
	0.11				A															A	A
Multi-story building • Small ¹ • Medium ² • Large ³	0.01	A	None	A	A	A	None	B	A	0.28 0.29 0.29	B	None	C	A	0.39 0.40 0.41	C	None	D	A		
	0.01				A															A	A
	0.01				A															A	A

Notes:

1. Room size: 12 ft. x 12 ft. x 10 ft. high
2. Room size: 12 ft. x 24 ft. x 10 ft. high
3. Room size: 18 ft. x 24 ft. x 10 ft. high
4. Windows are not included because areas are interior spaces.

Table A-56. Building Cost Increases for Electronic Emanations Eavesdropping Tactic						
Building Type	% Increase	Walls	Windows	Doors	Ceiling / Roof	
Building Exterior Shielded	Dining Facility	27.3	TEMPEST shielding in walls	Specially manufactured TEMPEST windows	Specially manufactured TEMPEST doors	TEMPEST shielding in roof or ceiling
	Administrative Facility	53.1				
	Medical Clinic	34.1				
	Barracks with Exterior Entries	46.7				
	Barracks with Interior Entries	17.8				
	Special Structure	34.1				
Interior Room Shielded	1 story building <ul style="list-style-type: none"> • Small ¹ • Medium ² • Large ³ 	1.44 1.69 1.85	None	None	None	None
	Multi-story building <ul style="list-style-type: none"> • Small ¹ • Medium ² • Large ³ 	1.35 1.55 1.69				
<p>1. Room size: 12 ft. x 12 ft. x 10 ft. high 2. Room size: 12 ft. x 24 ft. x 10 ft. high 3. Room size: 18 ft. x 24 ft. x 10 ft. high</p>						

Table A-57. Sitework Cost Multipliers

Tactic	Barrier Type	Threat Severity Level	Cost Multiplier ¹	Construction
Moving Vehicle Bomb	Passive Perimeter	Minimum	1.2	B
		Low	1.3	C
		Medium	1.4	D
		High	5.0	E
		Very High	7.5	F
		Special Case	8.5	G
	Active	Minimum	1.0	I
		Low	5.6	J
		Medium	7.4	K
		High	7.4	L
		Very High	11.1	M
	Special Case	16.7	N	
Stationary Vehicle Bomb	Passive Perimeter	All	1.0	A
	Active	All	1.0	H
Direct Fire Weapons	Screen	Very High ²	2.3	O
<p>1. Cost multipliers based on Standard 8-foot chain link fence (7-foot fabric with outrigger) for passive perimeter barriers and a motorized 8-foot high x 12 feet wide chain link gate for active barriers.</p> <p>2. Predetonation screen only. Directly hardening building for ballistics element of this tactic is less expensive than employing energy absorption screen.</p>				

This page intentionally left blank

APPENDIX B

RETROFIT CONSTRUCTION COST TABLES

B-1 INTRODUCTION. The purpose of the tables in this appendix is to provide planning level estimates of cost increases for retrofit construction for buildings representative of those commonly built by the Department of Defense. The costs tabulated represent the costs to meet the design criteria as percentages of new construction costs for the common existing conventional construction for those building types or rooms within buildings of those types. Presenting retrofit costs as increases over new construction costs was done because new construction costs for common military construction can be easily identified.

B-2 NAVIGATING THE TABLES. Table B-1 provides a guide to locating the cost tables for various threats. It is organized by tactic, threat severity level, and level of protection for all but the hand delivered devices and forced entry tactics. For the hand delivered devices tactic, the costs are tabulated by external attack, attacks on interior spaces for improvised incendiary devices, and attacks on mail rooms, loading docks, and entrance areas using different explosive weights.

B-3 BUILDING COMPONENT COST FORMULATION. The cost tables were formulated by arraying a number of components that would meet the requirements of mitigating the effects of particular tactics to the applicable threat severity levels and levels of protection. Those components were then sorted based on cost, and the least cost components were entered into a building cost model. That building cost model included the new construction baseline costs of the building components that were found to be commonly used for those buildings and that were representative of the building components that are in military construction pricing guidance. The costs in these tables are for an area cost factor of one.

The additional costs for the enhanced construction components over the conventional component costs were determined as a percentage increase over new conventional construction costs. The percentages of the building cost represented by each of the components were built into the model; therefore, the percentage increase in the total building costs represented by the enhanced building components could be determined. It is those cost increases that are tabulated. Note that in some retrofit tables there are not multiple levels of protection for all building components. In those cases there is insufficient development in the retrofit technologies to support different performances for different levels of protection, so one solution applies to multiple levels of protection.

Note that in the case of administrative buildings the cost increases are often very high. That is due to the fact that those buildings commonly have a high percentage of windows. Replacement windows to provide levels of protection against many of the threats covered by this UFC are very costly. Reducing window areas in those buildings may be an effective way to reduce costs; however, this appendix does not directly support determining those cost reductions. In addition, note that Special

Structures are excluded from the cost increase tables for explosive related tactics (Tables B-2 – B-7). That is because for those structure types, existing construction is too variable to develop common cost models. For those structures, special cost studies will need to be performed.

B-4 PROGRESSIVE COLLAPSE COSTS. UFC 4-010-01, *DoD Minimum Antiterrorism Standards for Buildings*, requires that all inhabited buildings three stories or greater in height must be designed to resist progressive collapse. For existing buildings, that requirement applies when a building is undergoing renovations, modifications, repairs, and restorations whose costs exceed 50% of the replacement cost of the building. While Appendix A contains cost guidance for new construction, there are no such convenient relationships for existing construction, and those buildings must be evaluated for progressive collapse on a case by case basis; therefore, those costs are not included on this appendix.

B-4. SITEWORK COST MULTIPLIERS. Sitework costs are tabulated in Table B-39 as multiples of a baseline barrier. The baseline barrier is either an 8-foot chain link fence (7-foot fabric with outrigger) or an 8-foot high, 12-foot wide (one traffic lane) motorized chain link gate. The costs of those two barriers are easily located in commercial cost estimating guides or in military construction cost databases. The cost multipliers for other barriers were determined by comparing the costs of those barriers to the costs of the baseline barriers. The barriers in Table B-39 are identified by threat severity level for perimeter and active barriers. The barriers associated with those threat severity levels are identified in Appendix C. Boat barrier costs are not included because the costs vary widely and the design guidance is still being developed.

Table B-1. Guide to Retrofit Cost Tables

Table B-1. Guide to Retrofit Cost Tables							
Tactic	Threat Severity Level	Explosive Weight or other Information	Level of Protection	Table	Page		
Vehicle Bombs¹	VL	25 kg (55 lbs)	All	B-2	B-5		
	L	100 kg (220 lbs)	All	B-3	B-6		
	M	250 kg (550 lbs)	All	B-4	B-8		
	H	500 kg (1100 lbs)	All	B-5	B-10		
	VH	2000 kg (4400 lbs)	All	B-6	B-12		
	Special Case	9000 kg (19,800 lbs)	All	B-7	B-14		
Hand Delivered Devices	Exterior¹	L	IID Only	All	B-8	B-16	
		M	1 kg (2.2 lbs)	All	B-9	B-16	
		H	25 kg (55 lbs)	VL	Not Applicable ²		
				L	B-2	B-5	
				M			
		H					
	All Interior Spaces	L	IID Only	No cost increases ³			
	Mail rooms	M & H	1 kg (2.2 lbs)	All	B-10	B-17	
	Loading Docks	M	1 kg (2.2 lbs)	All	B-11	B-18	
		H	25 kg (55 lbs)	All	B-12	B-19	
	Entry Areas	M	1 kg (2.2 lbs)	All	B-13	B-20	
H		25 kg (55 lbs)	All	B-14	B-21		
Indirect Fire Weapons	L	IID	All	B-15	B-22		
	M	82 mm Mortar	All	B-16	B-23		
	H	Rocket	All	B-17	B-24		
	VH	Imp. Mortar	Not Provided ⁴				
Direct Fire Weapons	L	UL Level 3	All	B-18	B-25		
	M	UL Level 5	All	B-19	B-26		
	H	UL Level 8	All	B-20	B-27		
	VH	Antitank & .50 caliber	All	B-21	B-28		

Table B-1 (continued)

Waterfront Attacks (surface / submerged)		L	100 / 25 kg UL Level 5	All	B-3/B-2 B-19	B-6/B-5 B-26
		M	250 / 25 kg UL Level 10.	All	B-4/B-2 B-21	B-8/B-5 B-28
		H	500 kg expl. AT & Level 10	All	B-5/B-2 B-21	B-10/B-5 B-28
Forced Entry	Exterior ⁶	L	Various Forced Entry Tools	All	B-22	B-29
		M		All	B-23	B-30
		H		All	B-24	B-31
		VH		All	B-25	B-32
	Interior ⁶	L	Various Forced Entry Tools	All	B-26	B-33
		M		All	B-27	B-35
		H		All	B-28	B-37
		VH		All	B-28 ⁵	B-37
Covert Entry		L	None	All	B-29	B-39
		M		All	B-30	B-39
		H		All	B-31	B-40
		VH		All	B-32	B-40
Acoustics Eaves- dropping	Exterior ⁶	H	Sound amplification devices	All	B-33	B-41
	Interior ⁶				B-34	B-42
Elect. Eman. Eaves	Exterior ⁶	H	Emanations. interception equipment	All	B-35	B-43
	Interior ⁶					
Visual Surveillance		H	Ocular Devices	H	B-36	B-44
Airborne Contamination		All	Chem, Bio and Rad. Agents	All	B-37	B-44
Waterborne Contamination		All	Chem, Bio and Rad. Agents	All	B-38	B-45
Sitework Costs		All		All	B-39	B-45

1. Special structures not included. See paragraph B-3.

2. Very low level of protection is not tabulated because baseline construction for all six building types will provide the very low level of protection as close as 10 meters, and no standoff distances less than 10 meters were included in this manual due to requirements in UFC 4-010-01.

3. No cost increases over conventional construction because interior construction is commonly fire resistant already and it is assumed there are no windows.

4. There are no practical retrofits for the improvised mortar.

5. Very high threat severity level not tabulated because it includes explosives, which are considered unlikely for interior use due to collateral damage. Use cost for High threat severity level.

6. Use the exterior tables where entire buildings or large portions of them are to be protected. In the latter case, use percentages of the costs shown in the table based on the percentage of building perimeter area that will be protected. Use interior tables where protection will be focused on interior rooms within buildings.

Combinations of interior and exterior costs can also be used where applicable.

Table B-2. 25 kg TNT – All Levels of Protection

Standoff Distance In Meters	% Increase		Construction Type				Standoff Distance In Meters	% Increase		Construction Type				Standoff Distance In Meters	%Δ	Construction Type			
	Admin Facility	Medical Clinic	Walls ²	Windows	Doors	Roofs		Barracks (Ext. Ent.)	Barracks (Int. Ent.)	Walls ²	Windows	Doors	Roofs		Dining Facility	Walls ²	Windows	Doors	Roofs
10.0 – 13.3	25.7	11.4	D	B	B	4	10.0 – 13.3	14.4	8.3	A	B	B	4	10.0 – 10.8	11.7	D	B	B	12
	31.9	14.3	K					E	15.9	K									
13.4 – 14.5	25.2	10.7	D	B	B	3	13.4 – 14.5	14.2	8.1	A	B	B	3	10.9 – 12.1	10.6	D	B	B	11
	31.5	13.7	K					E	14.8	K									
14.6 – 15.7	24.8	10.6	D	A	B	3	14.6 – 15.7	14.1	8.0	A	B	B	3	12.2 – 13.2	10.0	D	B	B	10
	31.0	13.6	K					E	14.2	K									
15.8 – 16.0	24.7	10.4	D	A	B	2	15.8 – 16.0	14.0	7.9	A	A	B	3	13.3 – 14.5	7.6	D	B	B	9
	30.9	13.4	K					E	11.8	K									
16.1 – 20.9	22.5	7.0	D	A	B	1	16.1 – 20.9	12.8	6.6	A	A	B	1	14.6 – 20.9	7.5	D	A	B	9
	28.8	10.0	K					E	11.7	K									
21.0 – 24.9	21.4	5.5	D	A	A	1	21.0 – 24.9	6.1	6.0	A	A	A	1	21.0 – 24.9	6.5	D	A	A	9
	27.6	8.5	K					E	10.7	K									
≥ 25.0	15.3	2.6	cc	A	A	1	≥ 25.0	2.6	2.6	cc	A	A	1	≥ 25.0	2.4	cc	A	A	9
	15.3	2.6	cc					cc	2.4	cc									

Notes:

1. For percentage cost increases, upper percentage is for non-load bearing wall construction and lower percentage is for load bearing wall construction
2. For walls, upper letter applies to retrofits for non-load bearing walls and lower letter applies to retrofits for load bearing walls.
3. cc = conventional construction. No retrofits required.
4. Percentages of cost increases are over new construction costs for the applicable building types

Table B-3. 100 kg TNT – All Levels of Protection

Standoff Distance In Meters	% Increase		Construction Type				Standoff Distance In Meters	% Increase		Construction Type				Standoff Distance In Meters	%Δ	Construction Type			
	Admin Facility	Medical Clinic	Walls	Windows	Doors	Roofs		Barracks (Ext. Ent.)	Barracks (Int. Ent.)	Walls	Windows	Doors	Roofs			Dining Facility	Walls	Windows	Doors
10.0 – 10.1	30.9	13.2	D	E	B	5	10.0 -10.1	16.2	10.1	D	E	B	5	10.0 – 10.1	12.4	D	E	B	12
	-	-	-					-	-	-					-	-			
10.1 – 14.9	28.9	12.9	D	D	B	5	10.1 – 10.4	15.8	9.7	D	D	B	5	10.1 – 14.9	12.1	D	D	B	12
	-	-	-					-	-	-					-				
15.0 – 20.3	28.9	12.9	D	D	B	5	10.5 – 11.2	15.5	9.4	C	D	B	5	15.0 – 20.3	12.1	D	D	B	12
	35.1	15.9	K					-	-	-					16.3	K			
20.4 – 20.9	26.4	12.5	D	C	B	5	11.3 – 12.4	15.5	9.4	C	D	B	5	20.4 – 28.6	11.7	D	C	B	12
	32.6	15.4	K					18.1	11.9	J					15.9	K			
21.0 – 24.2	26.3	12.4	D	B	B	5	12.5 – 15.7	15.3	9.2	B	D	B	5	28.7 – 29.2	10.6	D	B	B	11
	32.6	15.4	K					17.3	11.2	I					14.8	K			
24.3 – 29.2	25.7	11.4	D	B	B	4	15.8 – 17.6	15.3	9.2	B	D	B	5	29.3 – 31.9	10.5	D	A	B	11
	31.9	14.3	K					16.8	10.7	G					14.7	K			
29.3 – 34.3	25.2	11.3	D	A	B	4	17.7 – 20.3	15.3	9.2	A	D	B	5	32.0 – 34.6	9.9	D	A	B	10
	31.5	14.3	K					16.5	10.4	F					14.1	K			
34.5 – 39.8	24.8	10.6	D	A	B	3	20.4 – 22.5	14.8	8.7	A	C	B	5	34.7 – 44.9	7.5	D	A	B	9
	31.0	13.6	K					16.1	10.0	F					11.7	K			
39.9 – 40.4	24.7	10.4	D	A	B	2	22.6 – 24.2	14.8	8.7	A	C	B	5	45.0 – 48.9	3.4	cc	A	B	9
	30.9	13.4	K					15.7	9.6	E					3.4	cc			
40.5 – 44.9	22.5	7.0	D	A	B	1	24.3 – 29.2	14.4	8.3	A	B	B	4	≥ 49.0	2.4	cc	A	A	9
	16.4	4.1	K					15.3	9.1	E					2.4	cc			
45.0 – 48.9	15.3	4.1	cc	A	A	1	29.3 – 34.4	14.3	8.2	A	A	B	4	UFC 4-020-01 11 September 2008					
	15.3	4.1	cc					15.2	9.1	E									
≥ 49.0	15.3	2.6	cc	A	A	1	34.5 – 39.8	14.1	8.0	A	A	B	3						
	15.3	2.6	cc					14.9	8.8	E									
							39.9 – 40.4	14.0	7.9	A	A	B	2						
								14.9	8.7	E									

Table B-3 (continued)

40.5 – 44.9	12.8	6.0	A	A	B	1
	13.6	6.9	E			
45.0 – 48.9	9.3	2.6	cc	A	A	1
	9.3	2.6	cc			
≥ 49.0	2.6	2.6	cc	A	a	1
	2.6	2.6	cc			

Notes:

1. For walls, upper letter applies to retrofits for non-load bearing walls and lower letter applies to retrofits for load bearing walls.
2. For load bearing walls, a “-“ entry means that no economical retrofit is available at that standoff distance
3. cc = conventional construction. No retrofits required.
4. Percentages of cost increases are over new construction costs for the applicable building types

Table B-4. 250 kg TNT – All Levels of Protection

Standoff Distance In Meters	% Increase		Construction Type				Standoff Distance In Meters	% Increase		Construction Type				Standoff Distance In Meters	%Δ	Construction Type			
	Admin Facility	Medical Clinic	Walls	Windows	Doors	Roofs		Barracks (Ext. Ent.)	Barracks (Int. Ent.)	Walls	Windows	Doors	Roofs		Dining Facility	Walls	Windows	Doors	Roofs
10.0 – 10.6	67.4	20.3	D	H	B	6	10.0 – 10.6	22.6	16.5	D	H	B	6	10.0 – 10.4	18.7	D	H	B	15
	-	-	-					-	-	-					-	-			
10.7 – 11.3	57.4	18.6	D	G	B	6	10.7 – 11.3	20.9	14.8	D	G	B	6	10.5 – 10.6	18.5	D	H	B	14
	-	-	-					-	-	-					-	-			
11.4 – 11.5	56.8	17.7	D	G	B	5	11.4 – 11.5	20.6	14.5	D	G	B	5	10.7 – 11.5	17.0	D	G	B	14
	-	-	-					-	-	-					-	-			
11.6 – 15.4	32.6	13.5	D	F	B	5	11.6 – 15.4	16.5	10.4	D	F	B	5	11.6 – 12.0	13.1	D	F	B	14
	-	-	-					-	-	-					-	-			
15.5 – 17.9	30.9	13.2	D	E	B	5	15.5 – 17.9	16.1	10.1	D	E	B	5	12.1 – 12.6	13.0	D	F	B	13
	-	-	-					-	-	-					-	-			
18.0 – 22.9	28.9	12.9	D	D	B	5	18.0 – 19.9	15.8	9.7	D	D	B	5	12.7 – 15.4	12.7	D	F	B	12
	-	-	-					-	-	-					-	-			
23.0 – 31.0	28.9	12.9	D	D	B	5	20.0 – 21.9	15.5	9.4	C	D	B	5	15.5 – 17.9	12.4	D	E	B	12
	35.1	15.9	K					-	-	-					-	-			
31.1 – 31.3	26.4	12.5	D	C	B	5	22.0 – 23.9	15.5	9.4	C	D	B	5	18.0 – 22.9	12.1	D	D	B	12
	32.6	15.4	K					-	-	-					-	-			
31.4 – 44.0	26.3	12.4	D	B	B	5	24.0 – 27.9	15.3	9.2	B	D	B	5	23.0 – 31.0	12.1	D	D	B	12
	32.6	15.4	K					-	-	-					-	-			
44.1 – 57.9	25.9	12.4	D	A	B	5	28.0 – 29.9	15.3	9.2	B	D	B	5	31.1 – 44.2	11.7	D	C	B	12
	32.1	15.3	K					-	-	-					-	-			
58.0 – 61.0	19.8	9.5	cc	A	B	5	30.0 – 31.0	15.3	9.2	A	D	B	5	44.2 – 52.3	11.6	D	A	B	12
	19.8	9.5	cc					-	-	-					-	-			

Table B-4 (continued)

61.1 – 71.5	18.7	7.7	cc	A	B	3	31.1 – 42.9	14.8	8.7	A	C	B	5	52.4 – 57.7	10.5	D	A	B	11																														
	18.7	7.7	cc					F	K																																								
71.6 – 72.8	18.6	7.5	cc	A	B	2	43.0 – 44.0	14.8	8.7	A	B	B	5	57.8 – 57.9	9.9	D	A	B	10																														
	18.6	7.5	cc					E	K																																								
72.9 – 83.9	16.4	4.1	cc	A	B	1	44.1 – 57.9	14.7	8.6	A	A	B	5	58.0 – 63.3	5.8	cc	A	B	10																														
	16.4	4.1	cc					E	cc																																								
≥ 84.0	15.3	2.6	cc	A	A	1	58.0 – 61.0	11.2	5.2	cc	A	B	5	63.4 – 79.9	3.4	cc	A	B	9																														
	15.3	2.6	cc					cc	cc																																								
							61.1 – 71.5	10.6	4.5	cc	A	B	3	≥ 84.0	2.4	cc	A	A	9																														
								10.6	4.5	cc					cc																																		
							71.6 – 72.8	10.5	4.4	cc	A	B	2																																				
								10.5	4.4	cc																cc																							
							72.9 – 83.9	9.3	3.1	cc	A	B	1																																				
								9.3	3.1	cc																												cc											
							≥ 84.0	2.6	2.6	cc	A	A	1																																				
								2.6	2.6	cc																																							

Notes:

1. For walls, upper letter applies to retrofits for non-load bearing walls and lower letter applies to retrofits for load bearing walls.
2. For load bearing walls, a “-“ entry means that no economical retrofit is available at that standoff distance
3. cc = conventional construction. No retrofits required.
4. Percentages of cost increases are over new construction costs for the applicable building types.

B-10

Table B-5. 500 kg TNT – All Levels of Protection

Standoff Distance In Meters	% Increase		Construction Type				Standoff Distance In Meters	% Increase		Construction Type				Standoff Distance In Meters	%Δ	Construction Type			
	Admin Facility	Medical Clinic	Walls	Windows	Doors	Roofs		Barracks (Ext. Ent.)	Barracks (Int. Ent.)	Walls	Windows	Doors	Roofs		Dining Facility	Walls	Windows	Doors	Roofs
13.5 – 15.4	67.4	20.3	D	H	B	6	13.5 – 15.4	22.6	16.5	D	H	B	6	13.7 – 19.9	21.9	D	H	B	17
	-	-	-					-	-	-					-	-			
15.5 – 17.0	57.4	18.6	D	G	B	6	15.5 – 17.0	20.9	14.8	D	G	B	6	14.0 – 15.4	18.7	D	H	B	15
	-	-	-					-	-	-					-	-			
17.1 – 18.5	33.2	14.5	D	F	B	6	17.1 – 18.5	16.8	10.7	D	F	B	6	15.5 – 16.9	17.1	D	G	B	15
	-	-	-					-	-	-					-	-			
18.6 – 21.8	32.6	13.5	D	F	B	5	18.6 – 21.8	16.5	10.4	D	F	B	5	17.0 – 17.1	17.0	D	G	B	14
	-	-	-					-	-	-					-	-			
21.9 – 25.5	30.9	13.2	D	E	B	5	21.9 – 25.5	16.2	10.1	D	E	B	5	17.1 – 19.6	13.1	D	F	B	14
	-	-	-					-	-	-					-	-			
25.6 – 26.9	28.9	12.9	D	D	B	5	25.6 – 26.9	15.8	9.7	D	D	B	5	19.7 – 20.6	13.0	D	F	B	13
	-	-	-					-	-	-					-	-			
27.0 – 41.4	28.9	12.9	D	D	B	5	27.0 – 27.4	15.8	9.7	D	D	B	5	20.7 – 21.8	12.7	D	F	B	12
	35.1	15.9	K					-	-	-					-				
41.5 – 41.7	26.4	12.5	D	C	B	5	27.5 – 29.9	15.8	9.7	D	D	B	5	21.9 – 25.5	12.4	D	E	B	12
	32.6	12.5	K					-	-	-					-				
41.8 – 59.3	26.3	12.4	D	B	B	5	30.0 – 30.9	15.5	9.4	C	D	B	5	25.6 – 26.9	12.1	D	D	B	12
	32.6	12.4	K					-	-	-					-				
59.4 – 65.8	25.9	12.4	D	A	B	5	31.0 – 36.9	15.5	9.4	C	D	B	5	27.0 – 41.4	12.1	D	D	B	12
	32.1	12.4	K					-	-	-					-				

Table B-5 (continued)

65.9 – 72.9	25.2	11.3	D	A	B	4	37.0 – 40.9	15.3	9.2	B	D	B	5	41.5 – 59.3	11.7	D	C	B	12							
	31.5	11.3	K					17.3	11.2	I					15.9	K										
73.0 – 75.4	19.1	8.4	cc	A	B	4	41.0 – 41.4	15.3	9.2	B	D	B	5	59.4 – 72.9	11.6	D	A	B	12							
	19.1	8.4	cc					16.8	10.7	G					15.8	K										
75.5 – 108.0	18.7	7.7	cc	A	B	3	41.5 – 45.9	14.9	8.8	B	C	B	5	73.0 – 81.5	7.5	cc	A	B	12							
	18.7	7.7	cc					16.4	10.3	G					7.5	cc										
108.1 – 110.2	18.6	6.0	cc	A	B	2	46.0 – 47.9	14.9	8.8	B	B	B	5	81.6 – 89.5	6.4	cc	A	B	11							
	18.6	6.0	cc					16.1	10.0	F					6.4	cc										
110.3 – 122.9	16.4	4.1	cc	A	B	1	48.0 – 59.3	14.8	8.7	A	B	B	5	89.6 – 97.5	5.8	cc	A	B	10							
	16.4	4.1	cc					16.1	10.0	F					5.8	cc										
≥ 123.0	15.3	2.6	cc	A	A	1	59.4 – 60.9	14.7	8.6	A	A	B	5	97.6 – 122.9	3.4	cc	A	B	9							
	15.3	2.6	cc					16.0	9.9	F					3.4	cc										
							61.0 – 65.8	14.7	8.6	A	A	B	5	≥ 123.0	2.4	cc	A	A	9							
								15.6	9.5	E					2.4	cc										
							65.9 – 72.9	14.3	8.2	A	A	B	4	73.0 – 91.4	10.8	4.8	cc	A	B	4						
								15.2	9.1	E					10.8	4.8	cc									
							91.5 – 108.0	10.6	4.5	cc	A	B	3	108.1 – 110.2	10.5	4.4	cc	A	B	2						
								10.6	4.5	cc					10.5	4.4	cc									
							110.3 – 122.9	9.3	3.1	cc	A	B	1	≥ 123.0	2.6	2.6	cc	A	A	1						
								9.3	3.1	cc					2.6	2.6	cc									

Notes:

1. For walls, upper letter applies to retrofits for non-load bearing walls and lower letter applies to retrofits for load bearing walls.
2. For load bearing walls, a “-“ entry means that no economical retrofit is available at that standoff distance
3. cc = conventional construction. No retrofits required.
4. Percentages of cost increases are over new construction costs for the applicable building types.

Table B-6. 2000 kg TNT – All Levels of Protection

Standoff Distance In Meters	% Increase		Construction Type				Standoff Distance In Meters	% Increase		Construction Type				Standoff Distance In Meters	%Δ	Construction Type			
	Admin Facility	Medical Clinic	Walls	Windows	Doors	Roofs		Barracks (Ext. Ent.)	Barracks (Int. Ent.)	Walls	Windows	Doors	Roofs			Dining Facility	Walls	Windows	Doors
25.9 – 28.7	70.4	25.1	D	H	B	7	25.9 – 28.7	24.3	18.3	D	H	B	7	25.9 – 29.2	21.9	D	H	B	17

28.8 – 29.2	67.4	20.3	D	H	B	6	28.8 – 29.2	22.6	16.5	D	H	B	6	29.3 – 32.2	20.3	D	G	B	17

29.3 – 32.2	57.4	18.6	D	G	B	6	29.3 – 32.2	20.9	14.8	D	G	B	6	32.3 – 33.4	16.5	D	F	B	17

32.3 – 40.4	33.2	14.5	D	F	B	6	32.3 – 40.4	16.8	10.7	D	F	B	6	33.5 – 36.7	16.2	D	F	B	16

40.5 – 47.1	31.5	14.2	D	E	B	6	40.5 – 47.1	16.5	10.4	D	E	B	6	36.8 – 40.4	13.3	D	F	B	15

47.2 – 48.8	29.5	13.9	D	D	B	6	47.2 – 48.8	16.2	10.1	D	D	B	6	40.5 – 45.2	13.0	D	E	B	15

48.9 – 52.9	28.9	12.9	D	D	B	5	48.9 – 52.9	15.8	9.7	D	D	B	5	45.3 – 47.1	12.9	D	E	B	14

53.0 – 71.8	28.9	12.9	D	D	B	5	53.0 – 59.7	15.8	9.7	D	D	B	5	47.2 – 51.9	12.6	D	D	B	14
	35.1	15.9	K	.	.	.		20.0	13.9	K
71.9 – 72.4	26.4	12.5	D	C	B	5	59.8 – 65.9	15.8	9.7	D	D	B	5	52.0 – 52.9	12.4	D	D	B	13
	32.6	15.4	K	.	.	.		18.1	11.9	J
72.5 – 103.5	26.3	12.4	D	B	B	5	66.0 – 68.9	15.8	9.7	D	D	B	5	53.0 – 55.0	12.4	D	D	B	13
	32.6	15.4	K	.	.	.		17.3	10.2	I	.	.	.		16.6	K	.	.	.
103.6 – 115.9	25.9	12.4	D	A	B	5	69.0 – 71.8	15.5	89.4	C	.	.	.		12.1	D	D	B	12
	32.1	15.3	K	.	.	.		17.3	11.2	I	D	B	5	55.1 – 71.8	16.3	K	D	B	11

B-12

Table B-6 (continued)

116.0 – 134.1	19.8	9.5	cc	A	B	5	71.9 – 72.4	15.1	9.0	C	C	B	5	71.9 – 103.5	11.7	D	C	B	12																				
	19.8	9.5	cc					16.9	10.8	I					15.9	K																							
134.2 – 185.5	19.1	8.4	cc	A	B	4	72.5 – 85.9	15.0	9.0	C	B	B	5	103.6 – 115.9	11.6	D	A	B	12																				
	19.1	8.4	cc					16.9	10.8	I					15.8	K																							
185.6 – 224.0	18.7	7.7	cc	A	B	3	86.0 – 86.1	14.9	8.8	B	B	B	5	116.0 – 179.0	7.5	cc	A	B	12																				
	18.7	7.7	cc					16.9	10.8	I					7.5	cc																							
224.1 – 287.6	18.6	7.5	cc	A	B	2	86.2 – 100.9	14.9	8.8	B	B	B	5	179.1 – 194.9	6.4	cc	A	B	11																				
	18.6	7.5	cc					16.4	10.3	G					6.4	cc																							
228.7 – 250.9	16.4	4.1	cc	A	B	1	101.0 – 103.5	14.9	8.8	B	B	B	5	195.0 – 214.6	5.8	cc	A	B	10																				
	16.4	4.1	cc					16.1	10.0	F					5.8	cc																							
≥ 251.0	15.3	2.6	cc	A	A	1	103.6 – 108.9	14.8	8.7	B	A	B	5	214.7 – 250.9	3.4	cc	A	B	9																				
	15.3	2.6	cc					16.0	9.9	F					3.4	cc																							
							109.0 – 115.9	14.7	8.6	A	A	B	5	≥ 251.0	2.4	cc	A	A	9																				
								16.0	9.9	F					2.4	cc																							
							116.0 – 134.1	11.2	5.2	cc	A	B	5																										
								11.2	5.2	cc																													
							134.2 – 185.5	10.8	4.8	cc	A	B	4																										
								10.8	4.8	cc																													
							185.6 – 224.0	10.6	4.5	cc	A	B	3																										
								10.6	4.5	cc																													
							224.1 – 228.6	10.5	4.4	cc	A	B	2																										
								10.5	4.4	cc																													
							228.7 – 250.9	9.3	3.1	cc	A	B	1																										
								9.3	3.1	cc																													
							≥ 251.0	2.6	2.6	cc	A	A	1																										
								2.6	2.6	cc																													

Notes:

1. For walls, upper letter applies to retrofits for non-load bearing walls and lower letter applies to retrofits for load bearing walls.
2. For load bearing walls, a “-“ entry means that no economical retrofit is available at that standoff distance
3. cc = conventional construction. No retrofits required.
4. Percentages of cost increases are over new construction costs for the applicable building types.

Table B-7. 9000 kg TNT – All Levels of Protection

Standoff Distance In Meters	% Increase		Construction Type				Standoff Distance In Meters	% Increase		Construction Type				Standoff Distance In Meters	%Δ	Construction Type			
	Admin Facility	Medical Clinic	Walls	Windows	Doors	Roofs		Barracks (Ext. Ent.)	Barracks (Int. Ent.)	Walls	Windows	Doors	Roofs		Dining Facility	Walls	Windows	Doors	Roofs
47.2 – 53.2	70.9	26.0	D	H	B	8	47.2 – 53.2	24.7	18.7	D	H	B	8	47.2 – 53.2	22.5	D	H	B	18
	-	-	-					-	-	-					-	-			
53.3 – 59.3	60.9	24.3	D	G	B	8	53.3 – 59.3	23.0	17.0	D	G	B	8	53.3 – 59.3	20.9	D	G	B	18
	-	-	-					-	-	-					-	-			
59.4 – 73.4	36.7	20.1	D	F	B	8	59.4 – 73.4	18.9	12.9	D	F	B	8	59.4 – 60.6	17.1	D	F	B	18
	-	-	-					-	-	-					-	-			
73.5 – 82.2	35.0	19.8	D	E	B	8	73.5 – 82.2	18.6	12.6	D	E	B	8	60.7 – 73.4	16.5	D	F	B	17
	-	-	-					-	-	-					-	-			
82.3 – 83.7	31.5	14.2	D	E	B	6	82.3 – 83.7	16.5	10.4	D	E	B	6	73.5 – 79.4	16.2	D	E	B	17
	-	-	-					-	-	-					-	-			
83.8 – 124.9	29.5	13.9	D	D	B	6	83.8 – 110.9	16.2	10.1	D	D	B	6	79.5 – 83.7	16.0	D	E	B	16
	-	-	-					-	-	-					-	-			
125.0 – 126.4	29.5	13.9	D	D	B	6	111.0 – 119.9	16.2	10.1	D	D	B	6	83.8 – 104.1	15.6	D	D	B	16
	35.7	16.8	K					-	-	-					-	-			
126.5 – 127.0	27.0	13.4	D	C	B	6	120.0 – 126.4	16.2	10.1	D	D	B	6	104.2 – 124.9	12.7	D	D	B	15
	33.2	16.4	K					-	-	-					-	-			
127.1 – 134.1	26.9	13.4	D	B	B	6	126.5 – 127.0	15.8	9.7	D	C	B	6	125.0 – 126.4	12.7	D	D	B	15
	33.2	16.4	K					-	-	-					-	-			
134.2 – 183.7	26.3	12.4	D	B	B	5	127.1 – 134.1	15.7	9.7	D	B	B	6	126.5 – 127.4	12.3	D	C	B	15
	32.6	15.4	K					-	-	-					-	-			
183.8 – 197.9	25.9	12.4	D	A	B	5	134.2 – 160.9	15.4	9.3	D	B	B	5	127.5 – 144.6	12.2	D	B	B	14
	32.1	15.3	K					-	-	-					-	-			

B-14

Table B-7 (continued)

198.0 – 260.0	19.8	9.5	cc	A	B	5	161.0 – 164.9	15.0	9.0	C	B	B	5	144.7 – 152.3	12.0	D	B	B	13						
	19.8	9.5	cc					16.9	10.8	I					16.2	K									
260.1 – 361.2	19.1	8.4	cc	A	B	4	165.0 – 183.7	15.0	9.0	C	B	B	5	152.4 – 183.7	11.7	D	B	B	12						
	19.1	8.4	cc					16.4	10.3	G					15.9	K									
361.3 – 441.3	18.7	7.7	cc	A	B	3	183.8 – 196.9	15.0	8.9	C	A	B	5	183.8 – 220.6	11.6	D	A	B	12						
	18.7	7.7	cc					16.3	10.2	G					15.8	K									
441.4 – 449.9	18.6	7.5	cc	A	B	2	197.0 – 197.9	14.8	8.7	B	A	B	5	220.7 – 367.9	7.5	cc	A	B	12						
	18.6	7.5	cc					16.3	10.2	G					7.5	cc									
450.0 – 480.9	16.4	4.1	cc	A	B	1	198.0 – 260.0	11.2	5.2	cc	A	B	5	368.0 – 397.3	6.4	cc	A	B	11						
	16.4	4.1	cc					11.2	5.2	cc					6.4	cc									
≥ 481.0	15.3	2.6	cc	A	A	1	260.1 – 361.2	10.8	4.8	cc	A	B	4	397.4 – 440.6	5.8	cc	A	B	10						
	15.3	2.6	cc					10.8	4.8	cc					5.8	cc									
							361.3 – 441.3	10.6	4.5	cc	A	B	3	440.7 – 480.9	3.4	cc	A	B	9						
								10.6	4.5	cc					3.4	cc									
							441.4 – 449.9	10.5	4.4	cc	A	B	2	≥ 481.0	2.4	cc	A	A	9						
								10.5	4.4	cc					2.4	cc									
							450.0 – 480.9	9.3	3.1	cc	A	B	1												
								9.3	3.1	cc															
							≥ 481.0	2.6	2.6	cc	A	A	1												
								2.6	2.6	cc															

Notes:

1. For walls, upper letter applies to retrofits for non-load bearing walls and lower letter applies to retrofits for load bearing walls.
2. For load bearing walls, a “-“ entry means that no economical retrofit is available at that standoff distance
3. cc = conventional construction. No retrofits required.
4. Percentages of cost increases are over new construction costs for the applicable building types.

Table B-8. Building Retrofit Cost Increases Hand Delivered Devices Low Threat Severity Level (IID only)															
Building Type	Low LOP				Medium LOP				High LOP						
	% Increase	Walls	Windows	Doors	Roof	% Increase	Walls	Windows	Doors	Roof	% Increase	Walls	Windows	Doors	Roof
Administrative Facility	10.1					10.1					10.1				
Medical Clinic	1.9					1.9					1.9				
Barracks with Exterior Entries	1.8	A	A	A	A	1.8	A	A	A	A	1.8	A	A	A	A
Barracks with Interior Entries	1.8					1.8					1.8				
Dining Facility	1.2					1.2					1.2				
Special Structure	1.9					1.9					1.9				

Table B-9. Building Retrofit Cost Increases Hand Delivered Devices Medium Threat Severity Level (Hand grenades and 1 kg IED only)															
Building Type	Low LOP				Medium LOP				High LOP						
	% Increase	Walls	Windows	Doors	Roof	% Increase	Walls	Windows	Doors	Roof	% Increase	Walls	Windows	Doors	Roof
Administrative Facility	10.1					10.1					41.3	B			
Medical Clinic	1.9					1.9					18.0	B			
Barracks with Exterior Entries	1.8	A	A	A	A	1.8	A	A	A	A	20.1	D	B	A	B
Barracks with Interior Entries	1.8					1.8					9.5				
Dining Facility	1.2					1.2					14.0				
Special Structure	1.9					1.9					18.0				

Table B-10. Retrofit Cost Increases for Mail rooms 1 kg TNT Explosive						
Building Type	Low Level of Protection		Medium Level of Protection		High Level of Protection	
	% Cost Increase	Construc-tion	% Cost Increase	Construc-tion	% Cost Increase	Construc-tion
Dining Facility • Small ¹ • Medium ² • Large ³	1.1 1.6 2.3	See Table C-6	1.1 1.6 2.3	See Table C-6	1.1 1.6 2.4	See Table C-6
Administration Building • Small ¹ • Medium ² • Large ³	1.1 1.6 2.3		1.1 1.6 2.3		1.1 1.6 2.3	
Medical Clinic • Small ¹ • Medium ² • Large ³	0.6 0.9 1.2		0.6 0.9 1.3		0.6 0.9 1.3	
Barracks with Exterior Entrances • Small ¹ • Medium ² • Large ³	0.3 0.4 0.5		0.3 0.4 0.5		0.3 0.4 0.6	
Barracks with Interior Entrances • Small ¹ • Medium ² • Large ³	0.3 0.4 0.6		0.3 0.4 0.6		0.3 0.4 0.6	
Special Structures • Small ¹ • Medium ² • Large ³	0.8 1.1 1.6		0.8 1.1 1.6		0.8 1.1 1.6	

1. 10 ft. x 20 ft. x 10 ft.
2. 16 ft. x 25 ft. x 10 ft.
3. 22 ft. x 32 ft. x 10 ft

**Table B-11. Retrofit Cost Increases for Loading Docks
1 kg TNT Explosive**

Building Type	Low Level of Protection		Medium Level of Protection		High Level of Protection	
	% Cost Increase	Construction	% Cost Increase	Construction	% Cost Increase	Construction
Dining Facility • Small ¹ • Medium ² • Large ³	1.1 1.8 2.8	See Table C-6	1.2 1.9 2.8	See Table C-6	1.2 1.9 3.0	See Table C-6
Administration Building • Small ¹ • Medium ² • Large ³	1.1 1.8 2.8		1.2 1.8 2.8		1.2 1.9 3.0	
Medical Clinic • Small ¹ • Medium ² • Large ³	0.6 1.0 1.5		0.6 1.0 1.5		0.7 1.1 1.6	
Barracks with Exterior Entrances • Small ¹ • Medium ² • Large ³	0.3 0.4 0.6		0.3 0.4 0.7		0.3 0.5 0.7	
Barracks with Interior Entrances • Small ¹ • Medium ² • Large ³	0.3 0.5 0.7		0.3 0.5 0.7		0.3 0.5 0.7	
Special Structures • Small ¹ • Medium ² • Large ³	0.8 1.3 1.9		0.8 1.3 1.9		0.8 1.3 2.0	

1. 10 ft. x 22 ft. x 10 ft.
2. 10 ft. x 34 ft. x 10 ft.
3. 22 ft. x 46 ft. x 10 ft.

**Table B-12. Retrofit Cost Increases for Loading Docks
25 kg TNT Explosive**

Building Type	Low Level of Protection		Medium Level of Protection		High Level of Protection	
	% Cost Increase	Construction	% Cost Increase	Construction	% Cost Increase	Construction
Dining Facility • Small ¹ • Medium ² • Large ³	1.7 2.8 4.2	See Table C-7	1.8 2.9 4.4	See Table C-7	1.9 3.0 4.7	See Table C-7
Administration Building • Small ¹ • Medium ² • Large ³	1.7 2.7 4.2		1.8 2.9 4.4		1.9 3.0 4.7	
Medical Clinic • Small ¹ • Medium ² • Large ³	0.9 1.5 2.3		1.0 1.6 2.4		1.0 1.6 2.6	
Barracks with Exterior Entrances • Small ¹ • Medium ² • Large ³	0.4 0.6 1.0		0.4 0.7 1.0		0.5 0.7 1.1	
Barracks with Interior Entrances • Small ¹ • Medium ² • Large ³	0.4 0.7 1.0		0.5 0.7 1.1		0.5 0.7 1.2	
Special Structures • Small ¹ • Medium ² • Large ³	1.2 1.9 2.9		1.3 2.0 3.0		1.3 2.1 3.2	

1. 10 ft. x 22 ft. x 10 ft.
2. 10 ft. x 34 ft. x 10 ft.
3. 22 ft. x 46 ft. x 10 ft.

Table B-13. Retrofit Cost Increases for Entry Areas 1 kg TNT Explosive						
Building Type	Low Level of Protection		Medium Level of Protection		High Level of Protection	
	% Cost Increase	Construction	% Cost Increase	Construction	% Cost Increase	Construction
Dining Facility • Small ¹ • Medium ² • Large ³	1.6 2.4 4.7	See Table C-6	1.7 2.4 4.7	See Table C-6	1.7 2.5 4.8	See Table C-6
Administration Building • Small ¹ • Medium ² • Large ³	1.6 2.3 4.7		1.6 2.4 4.7		1.7 2.4 4.7	
Medical Clinic • Small ¹ • Medium ² • Large ³	0.9 1.3 2.6		0.9 1.3 2.6		0.9 1.3 2.6	
Barracks with Exterior Entrances • Small ¹ • Medium ² • Large ³	0.4 0.6 1.1		0.4 0.6 1.1		0.4 0.6 1.1	
Barracks with Interior Entrances • Small ¹ • Medium ² • Large ³	0.4 0.6 1.2		0.4 0.6 1.2		0.4 0.6 1.2	
Special Structures • Small ¹ • Medium ² • Large ³	1.1 1.6 3.2		1.1 1.6 3.2		1.2 1.7 3.2	
1. 15 ft. x 30 ft. x 10 ft. 2. 20 ft. x 40 ft. x 10 ft. 3. 40 ft. x 50 ft. x 10 ft.						

Table B-14. Retrofit Cost Increases for Entry Areas 25 kg TNT Explosive						
Building Type	Low Level of Protection		Medium Level of Protection		High Level of Protection	
	% Cost Increase	Construction	% Cost Increase	Construction	% Cost Increase	Construction
Dining Facility • Small ¹ • Medium ² • Large ³	2.3 3.3 6.8	See Table C-7	2.3 3.5 7.3	See Table C-7	2.5 3.6 7.6	See Table C-7
Administration Building • Small ¹ • Medium ² • Large ³	2.2 3.2 6.8		2.3 3.4 7.2		2.5 3.6 7.6	
Medical Clinic • Small ¹ • Medium ² • Large ³	1.2 1.8 3.7		1.3 1.9 4.0		1.3 2.0 4.1	
Barracks with Exterior Entrances • Small ¹ • Medium ² • Large ³	0.5 0.8 1.6		0.5 0.8 1.7		0.6 0.8 1.8	
Barracks with Interior Entrances • Small ¹ • Medium ² • Large ³	0.6 0.8 1.7		0.6 0.9 1.8		0.6 0.9 1.9	
Special Structures • Small ¹ • Medium ² • Large ³	1.5 2.2 4.7		1.6 2.4 5.0		1.7 2.5 5.2	
1. 15 ft. x 30 ft. x 10 ft. 2. 20 ft. x 40 ft. x 10 ft. 3. 40 ft. x 50 ft. x 10 ft.						

**Table B-15. Retrofit Cost Increases for Indirect Fire Weapons
Low Threat Severity Level**

Building Type	Low LOP				Medium LOP				High LOP						
	% Increase	Walls	Windows	Doors	Roof	% Increase	Walls	Windows	Doors	Roof	% Increase	Walls	Windows	Doors	Roof
Dining Facility	1.3					1.3					1.3				
Administrative Facility	10.1					10.1					10.1				
Medical Clinic	1.8					1.8					1.8				
Barracks with Exterior Entrances	1.8	cc	A	cc	cc	1.8	cc	A	cc	cc	1.8	cc	A	cc	cc
Barracks with Interior Entrances	1.8					1.8					1.8				
Special Structure	1.8					1.8					1.8				

cc = conventional construction. The baseline construction for those components is adequate

**Table B-16. Retrofit Cost Increases for Indirect Fire Weapons
Medium Threat Severity Level**

Building Type	Low LOP							Medium LOP							High LOP						
	% Increase	Walls	Wall Extensions	Windows	Doors	Hardened Roof	Sacrificial Roof	% Increase	Walls	Wall Extensions	Windows	Doors	Hardened Roof	Sacrificial Roof	% Increase	Walls	Wall Extensions	Windows*	Doors	Hardened Roof	Sacrificial Roof
Dining Facility	14.0	A	A	A	A	2	2	22.2	E	A	A	A	3	2	<i>Designing retrofits to meet this level of protection for this threat is not practical for conventional buildings</i>						
Administrative Facility	22.3	A	A	A	A	2	2	33.4	E	A	A	A	3	2							
Medical Clinic	14.1	A	A	A	A	2	1	21.4	E	A	A	A	3	1							
Barracks with Exterior Entrances	16.3	B	B	A	A	2	2	16.6	B	B	A	A	3	2							
Barracks with Interior Entrances	9.4	B	B	A	A	2	2	9.7	B	B	A	A	3	2							
Special Structure	21.1	B	B	A	A	2	2	21.8	B	B	A	A	3	2							

Table B-17. Retrofit Cost Increases for Indirect Fire Weapons High Threat Severity Level																					
Building Type	Low LOP							Medium LOP							High LOP						
	% Increase	Walls	Wall Extensions	Windows	Doors	Hardened Roof	Sacrificial Roof	% Increase	Walls	Wall Extensions	Windows	Doors	Hardened Roof	Sacrificial Roof	% Increase	Walls	Wall Extensions	Windows*	Doors	Hardened Roof	Sacrificial Roof
Dining Facility	31.6	F	A	A	A	7	2	<i>Designing retrofits to meet this level of protection for this threat is not practical for conventional buildings</i>	<i>Designing retrofits to meet this level of protection for this threat is not practical for conventional buildings</i>	<i>Designing retrofits to meet this level of protection for this threat is not practical for conventional buildings</i>	<i>Designing retrofits to meet this level of protection for this threat is not practical for conventional buildings</i>	<i>Designing retrofits to meet this level of protection for this threat is not practical for conventional buildings</i>	<i>Designing retrofits to meet this level of protection for this threat is not practical for conventional buildings</i>	<i>Designing retrofits to meet this level of protection for this threat is not practical for conventional buildings</i>	<i>Designing retrofits to meet this level of protection for this threat is not practical for conventional buildings</i>	<i>Designing retrofits to meet this level of protection for this threat is not practical for conventional buildings</i>	<i>Designing retrofits to meet this level of protection for this threat is not practical for conventional buildings</i>	<i>Designing retrofits to meet this level of protection for this threat is not practical for conventional buildings</i>			
Administrative Facility	46.2	F	A	A	A	7	2														
Medical Clinic	29.5	F	A	A	A	7	1														
Barracks with Exterior Entrances	19.6	D	B	A	A	7	2														
Barracks with Interior Entrances	11.2	D	B	A	A	7	2														
Special Structure	23.4	D	B	A	A	7	2														

Table B-18. Retrofit Cost Increases for Direct Fire Weapons Low Threat Severity Level (Retrofit Construction)																
Building Type	Low LOP				High LOP											
	% Increase	Walls	Windows	Doors	Roof	% Increase¹	Walls	Windows	Doors	Roof²						
Dining Facility	0.3	A	A	A	A	5.8	B	B	B	A						
						14.1				B						
Administration Building	2.0											28.7				A
						34.7				B						
Medical Clinic	0.4											6.1				A
						13.6				B						
Barracks with Exterior Entrances	0.3											19.4				A
						23.6				B						
Barracks with Interior Entrances	0.3											12.0				A
						16.2				B						
Special Structures	0.5											9.3				A
						26.7				B						

Note: Costs are for entire building exterior. For smaller portions of buildings use a straight percentage of protected perimeter ÷ total perimeter

1. For roofs to which there is no sightline, use top number in each pair of values for % cost increase. Where there is a sightline to a roof, use bottom number in each pair of values for % cost increase.

2. For roofs to which there is no sightline, the top roof designation in each pair indicates the roof construction on which the cost increase is based. The bottom roof designation in each pair indicates the roof construction on which the cost increase is based where there is a sightline to the roof.

Table B-19. Retrofit Cost Increases for Direct Fire Weapons Medium Threat Severity Level (Retrofit Construction)																
Building Type	Low LOP				High LOP											
	% Increase	Walls	Windows	Doors	Roof	% Increase¹	Walls	Windows	Doors	Roof²						
Dining Facility	0.3	A	A	A	A	17.4	C	C	C	A						
						32.4				C						
Administration Building	2.0											46.4				A
						57.2				C						
Medical Clinic	0.4											14.6				A
						28.0				C						
Barracks with Exterior Entrances	0.3											26.6				A
						34.1				C						
Barracks with Interior Entrances	0.3											16.6				A
						24.1				C						
Special Structures	0.5											10.3				A
						41.6				C						

Note: Costs are for entire building exterior. For smaller portions of buildings use a straight percentage of protected perimeter ÷ total perimeter

1. For roofs to which there is no sightline, use top number in each pair of values for % cost increase. Where there is a sightline to a roof, use bottom number in each pair of values for % cost increase.

2. For roofs to which there is no sightline, the top roof designation in each pair indicates the roof construction on which the cost increase is based. The bottom roof designation in each pair indicates the roof construction on which the cost increase is based where there is a sightline to the roof.

Table B-20. Retrofit Cost Increases for Direct Fire Weapons High Threat Severity Level (Retrofit Construction)										
Building Type	Low LOP				High LOP					
	% Increase	Walls	Windows	Doors	Roof	% Increase	Walls	Windows	Doors	Roof *
Dining Facility	0.3					22.7				
Administration Building	2.0					60.1				
Medical Clinic	0.4					19.0				
Barracks with Exterior Entrances	0.3	A	A	A	A	32.2	C	C	C	A
Barracks with Interior Entrances	0.3					22.1				
Special Structures	0.5					12.2				

Note: Costs are for entire building exterior. For smaller portions of buildings use a straight percentage of protected perimeter ÷ total perimeter

* Designing retrofits to a conventionally constructed roof to meet the high level of threat is not practical in cases where there are sightlines to roofs.

**Table B-21. Retrofit Cost Increases for Direct Fire Weapons
Very High Threat Severity Level
(Retrofit Construction)**

Building Type	Low LOP				Medium LOP				High LOP						
	% Increase	Walls	Windows	Doors	Roof	% Increase	Walls	Windows	Doors	Roof	% Increase	Walls	Windows	Doors	Roof
Dining Facility	0.3	A	A	A	A	Designing retrofits to meet this level of protection for this threat is not practical for conventional buildings					Designing retrofits to meet this level of protection for this threat is not practical for conventional buildings				
Administrative Facility	2.0														
Medical Clinic	0.4														
Barracks with Exterior Entrances	0.3														
Barracks with Interior Entrances	0.3														
Special Structure	0.5														

Table B-22. Retrofit Cost Increases for Forced Entry Tactic Low Threat Severity Level																				
Building Type	Low LOP				Medium LOP				High LOP				Very High LOP							
	% Increase	Walls	Windows	Doors	Roof	% Increase	Walls	Windows	Doors	Roof	% Increase	Walls	Windows	Doors	Roof	% Increase	Walls	Windows	Doors	Roof
Administrative Facility	22.6					26.4					29.4					37.1				
Medical Clinic	5.3					10.9					13.2					19.9				
Barracks with Exterior Entrances	7.8					10.3					13.9					21.5				
Barracks with Interior Entrances	5.6	A	A	A	A	8.0	C	B	A	D	10.0	D	B	C	G	14.2	E	C	E	F
Dining Facility	5.6					9.2					12.0					17.9				
Special Structure	13.5					19.1					24.9					37.0				
Note: Retrofitting existing windows to meet this requirement is impractical. Replace windows with wall construction with maximum openings of 96 square-inches																				

Table B-23. Retrofit Cost Increases for Forced Entry Tactic Medium Threat Severity Level																				
Building Type	Low LOP				Medium LOP				High LOP				Very High LOP							
	% Increase	Walls	Windows	Doors	Roof	% Increase	Walls	Windows	Doors	Roof	% Increase	Walls	Windows	Doors	Roof	% Increase	Walls	Windows	Doors	Roof
Administrative Facility	22.6					26.4					25.0					35.3				
Medical Clinic	5.3					10.1					22.4					32.1				
Barracks with Exterior Entrances	7.8					10.3					23.6					30.0				
Barracks with Interior Entrances	5.6	A	A	A	A	8.0	D	B	C	D	14.8	F	No*	H	G	21.2	G	No*	F	I
Dining Facility	5.6					9.2					20.0					28.5				
Special Structure	13.5					19.1					42.6					60.6				
Note: Retrofitting existing windows to meet this requirement is impractical. Replace windows with wall construction with maximum openings of 96 square-inches																				

Table B-24. Retrofit Cost Increases for Forced Entry Tactic High Threat Severity Level																				
Building Type	Low LOP				Medium LOP				High LOP				Very High LOP							
	% Increase	Walls	Windows	Doors	Roof	% Increase	Walls	Windows	Doors	Roof	% Increase	Walls	Windows	Doors	Roof	% Increase	Walls	Windows	Doors	Roof
Administrative Facility	22.1					40.1					36.1					45.8				
Medical Clinic	5.2					24.2					34.1					42.4				
Barracks with Exterior Entrances	7.7					21.2					21.4					38.6				
Barracks with Interior Entrances	5.6	A	A	A	B	17.1	F	B	D	G	22.0	G	No*	I	I	27.9	H	No*	J	J
Dining Facility	5.6					21.5					29.9					37.4				
Special Structure	13.4					45.2					62.3					79.4				
Note: Retrofitting existing windows to meet this requirement is impractical. Replace windows with wall construction with maximum openings of 96 square-inches																				

**Table B-25. Retrofit Cost Increases for Forced Entry Tactic
Very High Threat Severity Level**

Building Type	Low LOP				Medium LOP				High LOP				Very High LOP								
	% Increase	Walls	Windows	Doors	Roof	% Increase	Walls	Windows	Doors	Roof	% Increase	Walls	Windows	Doors	Roof	% Increase	Walls	Windows	Doors	Roof	
Administrative Facility	8.1					27.8															
Medical Clinic	4.8					22.1															
Barracks with Exterior Entrances	9.4					19.1															
Barracks with Interior Entrances	3.8	B	No	B	C	15.0	F	No*	F	H	Retrofit for these levels of protection is impractical at this threat severity level. Retrofit cost would exceed the cost of building replacement.										
Dining Facility	4.9					19.6															
Special Structure	11.6					42.0															
Note: Retrofitting existing windows to meet this requirement is impractical. Replace windows with wall construction with maximum openings of 96 square-inches																					

**Table B-26. Interior Area Retrofit Cost Increases for Forced Entry Tactic
Low Threat Severity Level**

Building Type	Low LOP				Medium LOP				High LOP				Very High LOP							
	% Increase	Walls	Windows	Doors	Roof	% Increase	Walls	Windows	Doors	Roof	% Increase	Walls	Windows	Doors	Roof	% Increase	Walls	Windows	Doors	Roof
Administrative Facility <ul style="list-style-type: none"> • Small ¹ • Medium ² • Large ³ 	0.2					0.3					0.4					0.5				
	0.4					0.5					0.6					0.9				
	0.6					0.7					0.9					1.2				
Medical Clinic <ul style="list-style-type: none"> • Small ¹ • Medium ² • Large ³ 	0.1	A	None ⁴	A	A	0.2	C	None ⁴	A	D	0.2	D	None ⁴	E	G	0.3	E	None ⁴	E	F
	0.2					0.3					0.3					0.5				
	0.3					0.4					0.5					0.6				
Barracks with Exterior Entries <ul style="list-style-type: none"> • Small ¹ • Medium ² • Large ³ 	0.1					0.1					0.1					0.1				
	0.1					0.1					0.2					0.2				
	0.1					0.2					0.2					0.3				

Table B-26 - continued

Barracks with Interior Entries																				
• Small ¹	0.1					0.1				0.1										
• Medium ²	0.1					0.1				0.2										
• Large ³	0.2					0.2				0.2										
Dining Facility		A	None ⁴	A	A		C	None ⁴	A	D		D	None ⁴	H	G		E	None ⁴	E	F
• Small ¹	0.2					0.3				0.4										
• Medium ²	0.4					0.5				0.6										
• Large ³	0.6					0.7				0.9										
Special Structure																				
• Small ¹	0.2					0.2				0.2										
• Medium ²	0.3					0.4				0.4										
• Large ³	0.4					0.5				0.6										

Notes:

1. Room size: 12 ft. x 12 ft. x 10 ft. high
2. Room size: 12 ft. x 24 ft. x 10 ft. high
3. Room size: 18 ft. x 24 ft. x 10 ft. high
4. Windows are not included because areas are interior spaces.

B-34

Table B-27. Interior Area Retrofit Cost Increases for Forced Entry Tactic Medium Threat Severity Level																				
Building Type	Low LOP				Medium LOP				High LOP				Very High LOP							
	% Increase	Walls	Windows	Doors	Roof	% Increase	Walls	Windows	Doors	Roof	% Increase	Walls	Windows	Doors	Roof	% Increase	Walls	Windows	Doors	Roof
Administrative Facility • Small ¹ • Medium ² • Large ³	0.2	A	None ⁴	A	A	0.3	D	None ⁴	C	D	0.7	F	None ⁴	I	G	0.9	G	None ⁴	F	I
	0.4					0.5					1.1					1.4				
	0.6					0.7					1.4					1.8				
Medical Clinic • Small ¹ • Medium ² • Large ³	0.1	A	None ⁴	A	A	0.2	D	None ⁴	C	D	0.4	F	None ⁴	I	G	0.5	G	None ⁴	F	I
	0.2					0.3					0.6					0.8				
	0.3					0.4					0.8					1.0				
Barracks with Exterior Entries • Small ¹ • Medium ² • Large ³	0.1	A	None ⁴	A	A	0.1	D	None ⁴	C	D	0.2	F	None ⁴	I	G	0.2	G	None ⁴	F	I
	0.1					0.1					0.3					0.3				
	0.1					0.2					0.3					0.4				

Table B-27 - continued

Barracks with Interior Entries																				
• Small ¹	0.1					0.1					0.2					0.2				
• Medium ²	0.1					0.1					0.3					0.4				
• Large ³	0.2					0.2					0.4					0.5				
Dining Facility		A	None ⁴	A	A		D	None ⁴	C	D		F	None ⁴	H	G		G	None ⁴	F	I
• Small ¹	0.2					0.3					0.7					0.9				
• Medium ²	0.4					0.5					1.1					1.4				
• Large ³	0.6					0.7					1.4					1.9				
Special Structure																				
• Small ¹	0.2					0.6					0.5					0.6				
• Medium ²	0.3					1.0					0.7					1.0				
• Large ³	0.4					1.4					1.0					1.3				

Notes:

1. Room size: 12 ft. x 12 ft. x 10 ft. high
2. Room size: 12 ft. x 24 ft. x 10 ft. high
3. Room size: 18 ft. x 24 ft. x 10 ft. high
4. Windows are not included because areas are interior spaces.

**Table B-28. Interior Area Retrofit Cost Increases for Forced Entry Tactic
High Threat Severity Level**

Building Type	Low LOP				Medium LOP				High LOP				Very High LOP							
	% Increase	Walls	Windows	Doors	Roof	% Increase	Walls	Windows	Doors	Roof	% Increase	Walls	Windows	Doors	Roof	% Increase	Walls	Windows	Doors	Roof
Administrative Facility <ul style="list-style-type: none"> • Small ¹ • Medium ² • Large ³ 	0.2					0.6					0.9					1.1				
	0.4					1.0					1.4					1.8				
	0.6					1.4					1.9					2.3				
Medical Clinic <ul style="list-style-type: none"> • Small ¹ • Medium ² • Large ³ 	0.1	A	None ⁴	A	A	0.3	E	None ⁴	D	G	0.5	G	None ⁴	I	I	0.6	H	None ⁴	J	J
	0.2					0.6					0.8					1.0				
	0.3					0.7					1.0					1.3				
Barracks with Exterior Entries <ul style="list-style-type: none"> • Small ¹ • Medium ² • Large ³ 	0.1					0.1					0.2					0.3				
	0.1					0.2					0.3					0.4				
	0.1					0.3					0.4					0.5				

Table B-28 - continued

Barracks with Interior Entries • Small ¹ • Medium ² • Large ³	0.1	A	None ⁴	A	A	0.2	F	None ⁴	D	G	0.2	G	None ⁴	I	I	0.3	H	None ⁴	J	J
	0.1					0.3					0.4					0.5				
	0.2					0.3					0.5					0.6				
Dining Facility • Small ¹ • Medium ² • Large ³	0.2					0.6					0.9					1.1				
	0.4					1.0					1.5					1.8				
	0.6					1.4					1.9					2.3				
Special Structure • Small ¹ • Medium ² • Large ³	0.2					0.4					0.6					0.8				
	0.3					0.7					1.0					1.2				
	0.4					0.9					1.3					1.6				
Notes: 1. Room size: 12 ft. x 12 ft. x 10 ft. high 2. Room size: 12 ft. x 24 ft. x 10 ft. high 3. Room size: 18 ft. x 24 ft. x 10 ft. high 4. Windows are not included because areas are interior spaces.																				

B-38

Table B-29. Retrofit Cost Increases for Covert Entry Tactic <i>Low Threat Severity Level</i>								
Building Type	Low Level of Protection		Medium Level of Protection		High Level of Protection		Very High Level of Protection	
	% Cost Increase	Equip. Set	% Cost Increase	Equip. Set	% Cost Increase	Equip. Set	% Cost Increase	Equip. Set
Dining Facility	0.11	B	0.74	C	1.25	D	1.95	E
Admin. Building	0.08	B	0.15	C	0.97	D	1.51	E
Medical Clinic	0.03	B	0.23	C	0.39	D	0.61	E
Barracks with Exterior Entrances	.02	B and A	.015	C and A	.026	D and A	0.40	E and A
Barracks with Interior Entrances	0.02	B and A	0.14	C and A	0.23	D and A	0.36	E and A
Special Structures	0.08	B	0.54	C	0.91	D	1.42	E

Table B-30 Retrofit Cost Increases for Covert Entry Tactic Medium Threat Severity Level								
Building Type	Low Level of Protection		Medium Level of Protection		High Level of Protection		Very High Level of Protection	
	% Cost Increase	Equip. Set	% Cost Increase	Equip. Set	% Cost Increase	Equip. Set	% Cost Increase	Equip. Set
Dining Facility	0.67	F	0.83	G	1.33	H	1.95	I
Admin. Building	0.52	F	0.64	G	1.03	H	1.51	I
Medical Clinic	0.21	F	0.26	G	0.42	H	0.61	I
Barracks with Exterior Entrances	0.14	F and A	0.17	G and A	0.28	H and A	0.40	I and A
Barracks with Interior Entrances	0.12	F and A	0.15	G and A	0.24	H and A	0.36	I and A
Special Structures	0.46	F	0.61	G	0.97	H	1.42	I

Table B-31 Retrofit Cost Increases for Covert Entry Tactic High Threat Severity Level								
Building Type	Low Level of Protection		Medium Level of Protection		High Level of Protection		Very High Level of Protection	
	% Cost Increase	Equip. Set	% Cost Increase	Equip. Set	% Cost Increase	Equip. Set	% Cost Increase	Equip. Set
Dining Facility	1.0	J	1.16	K	5.08	L	5.85	M
Admin. Building	0.77	J	0.9	K	3.93	L	4.52	M
Medical Clinic	0.31	J	0.36	K	1.59	L	1.83	M
Barracks with Exterior Entrances	0.21	J and A	0.24	K and A	1.05	L and A	1.21	M and A
Barracks with Interior Entrances	0.18	J and A	0.21	K and A	0.93	L and A	1.07	M and A
Special Structures	0.73	J	0.85	K	3.70	L	4.27	M

Table B-32 Retrofit Cost Increases for Covert Entry Tactic Very High Threat Severity Level								
Building Type	Low Level of Protection		Medium Level of Protection		High Level of Protection		Very High Level of Protection	
	% Cost Increase	Equip. Set	% Cost Increase	Equip. Set	% Cost Increase	Equip. Set	% Cost Increase	Equip. Set
Dining Facility	1.0	J	1.16	K	5.08	L	5.85	M
Admin. Building	0.77	J	0.9	K	3.93	L	4.52	M
Medical Clinic	0.31	J	0.36	K	1.59	L	1.83	M
Barracks with Exterior Entrances	0.21	J and A	0.24	K and A	1.05	L and A	1.21	M and A
Barracks with Interior Entrances	0.18	J and A	0.21	K and A	0.93	L and A	1.07	M and A
Special Structures	0.73	J	0.85	K	3.70	L	4.27	M

Table B-33. Building Retrofit Cost Multipliers for Acoustics Eavesdropping Tactic

Building Type	Low LOP				Medium LOP				High LOP				Very High LOP							
	% Increase	Walls	Windows	Doors	Roof	% Increase	Walls	Windows	Doors	Roof	% Increase	Walls	Windows	Doors	Roof	% Increase	Walls	Windows	Doors	Roof
Dining Facility	0					0.9					1.5					2.6				
Administrative Facility	0.9					3.1					4.4					8.0				
Medical Clinic	0.3					1.0					1.6					2.7				
Barracks with Exterior Entries	0.4	A	A	A	A	6.2	A	B	B	A	8.3	A	C	C	A	11.8	A	D	D	A
Barracks with Interior Entrances	0.2					0.8					1.1					1.8				
Special Structure	0.3					1.0					1.6					2.7				

B-41

Table B-34. Interior Area Retrofit Cost Increases for Acoustics Eavesdropping Tactic																								
Building Type	Low LOP (STC 30)				Medium LOP (STC 40)				High LOP (STC 45)				Very High LOP (STC 50)											
	% Increase	Walls	Windows	Doors	Ceiling	% Increase	Walls	Windows	Doors	Ceiling	% Increase	Walls	Windows	Doors	Ceiling	% Increase	Walls	Windows	Doors	Ceiling				
1 story building • Small ¹ • Medium ² • Large ³	0.05	A	None	A	B	0.25 0.30 0.34	A	None	B	F	0.35 0.41 0.46	B	None	C	D	0.46 0.54 0.61	C	None	D	G				
	0.09				A					A					A						A	A	A	A
	0.13				A					A					A						A	A	A	A
Multi-story building • Small ¹ • Medium ² • Large ³	0.01	A	None	A	A	0.21 0.21 0.21	A	None	B	A	0.30 0.32 0.29	B	None	C	A	0.41 0.43 0.44	C	None	D	A				
	0.01				A					A					A						A	A	A	A
	0.01				A					A					A						A	A	A	A

Notes:
1. Room size: 12 ft. x 12 ft. x 10 ft. high
2. Room size: 12 ft. x 24 ft. x 10 ft. high
3. Room size: 18 ft. x 24 ft. x 10 ft. high
4. Windows are not included because areas are interior spaces.

Table B-35. Building Retrofit Cost Increases for Electronic Emanations Eavesdropping Tactic						
Building Type	% Increase	Walls	Windows	Doors	Ceiling / Roof	
Building Exterior Shielded	Dining Facility	32.4	TEMPEST shielding in walls	Specially manufactured TEMPEST windows	Specially manufactured TEMPEST doors	TEMPEST shielding in rook or ceiling
	Administrative Facility	58.8				
	Medical Clinic	40.3				
	Barracks with Exterior Entries	50.6				
	Barracks with Interior Entries	21.3				
	Special Structure	40.3				
Interior Room Shielded	1 story building • Small ¹ • Medium ² • Large ³	1.53 1.85 2.05	None	None	Specially manufactured TEMPEST doors	TEMPEST shielding in rook or ceiling
	Multi-story building • Small ¹ • Medium ² • Large ³	1.42 1.67 1.83				
1. Room size: 12 ft. x 12 ft. x 10 ft. high 2. Room size: 12 ft. x 24 ft. x 10 ft. high 3. Room size: 18 ft. x 24 ft. x 10 ft. high						

Table B-36. Surveillance Tactic Cost Increases		
Building Type	% Cost Increase	Construction
Dining Facility	0.3%	0.10 mm (4-mil) reflective fragment retention film on windows
Administration Building	1.4%	
Medical Clinic	0.2%	
Barracks with Exterior Entrances	0.2%	
Barracks with Interior Entrances	0.2%	
Special Structures	0.3%	

Table B-37. Building Cost Increases for Airborne Contamination Mitigation (All Threat Severity Levels and Levels of Protection)						
Building Type	Low LOP		Medium LOP		High LOP	
	% Increase	HVAC Requirements	% Increase	HVAC Requirements	% Increase	HVAC Requirements
Dining Facility	1.6	See Table C-12	27.5	See Table C-12	44.7	See Table C-12
Administrative Facility	0.6		10.1		22.2	
Medical Clinic	1.1		18.9		29.6	
Barracks with Exterior Entrances	0.6		17.8		22.2	
Barracks with Interior Entrances	0.2		10.7		12.5	
Special Structure	1.6		52.8		74.2	

Table B-38. Costs to Mitigate Waterborne Contamination (All Building Types, Threat Severity Levels and Levels of Protection)						
Building Type	Level of Protection					
	Low LOP		Medium LOP		High LOP	
	%	O & M / year	%	O & M / year	%	O & M / year
Administrative Facility	0.4	0	6.1	\$30,000	10.5	\$30,000
Medical Clinic	0.1	0	2.5	\$30,000	4.3	\$30,000
Barracks with Exterior Entries	0.1	0	1.6	\$30,000	2.8	\$30,000
Barracks with Interior Entries	0.1	0	1.4	\$30,000	2.5	\$30,000
Dining Facility	0.5	0	7.9	\$30,000	13.6	\$30,000
Special Structure	0.3	0	5.7	\$30,000	9.9	\$30,000

Table B-39. Sitework Retrofit Cost Multipliers				
Tactic	Barrier Type	Threat Severity Level	Cost Multiplier¹	Construction
Moving Vehicle Bomb	Passive Perimeter	Minimum	1.2	B
		Low	1.3	C
		Medium	1.4	D
		High	5.0	E
		Very High	7.5	F
		Special Case	8.5	G
	Active	Minimum	1.0	I
		Low	5.6	J
		Medium	7.4	K
		High	7.4	L
		Very High	11.1	M
Stationary Vehicle Bomb	Passive Perimeter	All	1.0	A
	Active	All	1.0	H
Direct Fire Weapons	Screen	Very High ²	2.3	O
		Very High ³	10	P

1. Cost multipliers based on Standard 8-foot chain link fence with outrigger for perimeter barriers and motorized 8-foot high x 12 feet wide chain link gate
2. Predetonation screen only (anti-tank weapon only).
3. Energy absorption screen (anti-tank weapon and 12.7 mm ballistics).

This page intentionally left blank

APPENDIX C

CONSOLIDATED CONSTRUCTION COMPONENT TABLES

C-1 **INTRODUCTION.** The purpose of this appendix is to identify the construction components that were the basis for the cost tables in Appendices A and B. The baseline construction for the six common building types is also identified in this appendix. Table C-1 provides a guide to the construction component tables organized by tactic for all tactics except the hand delivered device tactic. For that tactic, the entries are organized by explosive weight and whether the threat is applied to the exterior or the interior of buildings.

C-2 **BASELINE CONSTRUCTION.** Table C-2 contains the baseline construction for the six common building types identified in Chapters 3 and 6 and for which the cost tables are tabulated in Appendices A and B. The building elements in Table C-2 are common to the building types identified in the tables and are representative of the construction upon which the baseline costs in the *DoD Facilities Pricing Guide (UFC 4-701-05)* are based. They may not be representative of how such buildings are built in all parts of the country or the world, but they represent very common construction. If common construction in your area is significantly different from a cost standpoint than that in Table C-2, the cost tables in Appendices A and B may not work for you or you may have to do some interpolating or extrapolating. Table C-2 also includes the percentages of the entire building cost represented by the major building components that are affected by security and antiterrorism (walls, doors, windows, and roofs). Those percentages may also be used to evaluate costs where local construction practices are different than the baseline construction in Table C-2.

C-3 **ENHANCED BUILDING CONSTRUCTION.** The building construction identified in tables C-3 through C-17 in this appendix is representative of construction that will mitigate the effects of the various threats identified. They do not represent the only possible selections. They only represent selections that reflect a representative minimum cost for providing the required protection using common construction practice. Issues specific to each of the tables in this appendix follow. They include both new construction and retrofit construction. For retrofit construction, all retrofit costs include the costs of removing existing building materials and providing new finished surfaces where applicable.

C-3.1 **Blast Resistant Exterior Construction.** Blast resistant exterior construction is described separately for new construction and retrofits to existing construction.

C3.1.1 **New Construction.** Table C-3 contains the walls, windows, doors, and roofs that were used in establishing the cost factors in Appendix A for vehicle bombs and hand delivered devices of 25 kg (55 lbs) or more. Additional costs for other building components are not included because necessary modifications to them generally do not have a significant impact on cost.

C-3.1.1.1 **Walls.** The walls are either reinforced concrete masonry using US standard concrete blocks or reinforced concrete. Reinforcement is based on the following ratios:

- Reinforced concrete
 - Heavy reinforcement: 0.50%
 - Moderate reinforcement: 0.25%
 - Light reinforcement: 0.15% (generally minimum reinforcement)
- Reinforced masonry
 - Heavy reinforcement: 0.30%
 - Moderate reinforcement: 0.15%
 - Light reinforcement: 0.05% (generally minimum reinforcement)

C-3.1.1.2 **Windows.** Windows are either laminated annealed glass or polycarbonate. The minimum window glazing in the table is the window required by the *DoD Minimum Antiterrorism Standards for Buildings (UFC 4-010-01)*.

C-3.1.1.3 **Doors.** Doors are either conventional hollow metal doors in steel frames or blast resistant doors designed to resist specific blast pressures (in pounds per square inch). The table also includes an option for providing backing walls constructed behind a conventional hollow metal door to intercept the door if it flies into the building in response to a blast or for providing conventional doors in foyers to serve a similar function.

C-3.1.1.4 **Roofs.** Roof construction includes both reinforced concrete flat slabs and steel deck on top of bar joists. The bar joists are built to US standards, so foreign made joists may not directly match.

C-3.1.2 **Retrofit Construction.** Table C-4 contains the walls, windows, doors, and roofs that were used in establishing the cost factors in Appendix B for vehicle bombs and hand delivered devices of 25 kg (55 lbs) or more. Additional costs for other building components are not included because necessary modifications to them generally do not have a significant impact on cost.

C-3.1.2.1 **Walls.** Wall retrofits are of two major types; those that may be used on masonry walls and those that can be used on lightweight construction. They also differ in that some may be used for load-bearing walls and others can only be used for non-load-bearing walls. The following retrofits are included:

C-3.1.2.1.1 **Steel Stud Retrofit.** This is a retrofit that can be applied to steel stud walls. It involves adding an additional steel stud wall in the interior of the building. That wall has back-to-back steel studs with special connections to steel channels. It also has light gage sheet steel on one side and polycarbonate reinforced gypsum wall board with sheet metal reinforcing strips on the other.

C-3.1.2.1.2 **Reinforced Concrete Backer Walls.** This retrofit can be applied behind masonry walls to minimize the debris from the masonry wall when it fails. They can be either bonded to the masonry or unbonded.

C-3.1.2.1.3. **High Capacity Wall Catcher System.** This retrofit uses foam block behind the existing wall and light gage sheet steel behind the foam blocks. The system is bolted to the floor and ceiling. It is designed to catch hazardous debris.

C-3.1.2.1.4 **Geotextile Fabric Retrofits.** This retrofit uses common geotextiles fastened to floors and ceilings behind existing masonry walls to minimize debris from the masonry wall when it fails.

C-3.1.2.2 **Windows.** Because retrofits applied in this UFC are assumed to be used as elements of major renovations, all window retrofits involve removing the existing windows and replacing them with new, blast resistant window assemblies.

C-3.1.2.3 **Doors.** Door retrofits in this UFC are limited to building foyers incorporating the existing doors to ensure that when they fail in response to a blast they will be caught by the foyer wall and not become hazardous flying debris.

C-3.1.2.4 **Roofs.** The most economical roof retrofits involve removing the old roofs and replacing them with the roofs specified for new construction.

C-3.2 **Construction Resistant to Hand Delivered Devices.** Table C-5 includes the walls, doors, windows, and roofs that are necessary to meet the requirements for small hand delivered devices delivered external to buildings. Tables C-6 and C-7 include construction to resist internal explosions in mail rooms, loading docks, and entry areas of multiple sizes.

C-3.2.1 **Walls.** Walls to resist externally delivered hand delivered devices of 1 kg (2.2 lbs) or less are either conventional construction of any sort, conventional masonry construction that is reinforced to the minimum requirements of the *DoD Minimum Antiterrorism Standards for Buildings (UFC 4-010-01)*, or lightly reinforced concrete. Walls to resist internal explosions are reinforced concrete with reinforcement ratios as discussed above. They are tabulated according to the purpose of the interior space (mail rooms, loading dock, or entry area), the size of the space, the explosive weight, and the level of protection. Exterior retrofits are similar to those described for other blast resistant construction. Interior retrofits assume it is more economical to remove existing interior walls and replace them with the same construction that would be used for new construction.

C-3.2.2 **Windows.** Windows to resist externally delivered devices of 1 kg (2.2 lbs) or less either have the minimum laminated glass required by the *DoD Minimum Antiterrorism Standards for Buildings (UFC 4-010-01)* or polycarbonate glazing. The latter is sized to resist fragments. There are no windows provided for internal explosions except those on the exterior walls of those areas. The exterior windows are laminated glass intended to fail quickly to allow the blast pressures to vent out of the

internal areas. As for other blast resistant construction, all window retrofits involve replacing the existing windows with appropriate new window assemblies.

C-3.2.3 **Doors.** Doors to resist externally delivered devices of 1 kg (2.2 lbs) or less are conventional hollow steel for all cases, except they are incorporated into entry foyers for higher levels of protection as described in Chapter 4. Doors for internal explosions are blast resistant doors, but their costs are not currently included in the tables in this appendix. Retrofitted doors similarly use foyers to back them up.

C-3.2.4 **Roofs.** Roofs to resist externally delivered devices of 1 kg (2.2 lbs) or less are either conventional construction or lightly reinforced concrete. Ceilings of rooms subject to internal explosions will be reinforced concrete reinforced according the reinforcement ratios described above. The basis for tabulating ceilings is the same as for walls. Retrofits to existing construction involve removing existing roofs and ceilings where necessary and replacing them with the same construction as is specified for new buildings.

C-3.3 **Construction to Resist Indirect Fire Weapons.** Construction to resist indirect fire weapons is in Table C-8 for new construction and Table C-9 for existing construction. In both cases construction must resist both the effects of blast pressures from the exploding rounds and the effects of the fragmentation of the warhead. It depends, therefore, significantly on mass. Considerations are similar for new construction and retrofits, but they will still be described separately here.

C-3.3.1 **New Construction.**

C-3.3.1.1 **Walls.** Walls must provide blast resistance similar to those described for blast resistant exterior construction, but they must also have sufficient mass to stop or significantly reduce the effects of the warhead fragments. For the lower threat severity level weapons and lower levels of protection, that can be done by slightly enhancing the baseline construction such as by spacing studs closer together for lightweight construction or lightly reinforcing masonry walls for the masonry construction. For all building types the exterior is assumed to have at least a clay brick face, which is sufficient to stop the fragments at those levels. At higher threat severity levels and levels of protection, walls become increasingly heavier reinforced concrete and reinforced concrete masonry.

C-3.3.1.2 **Windows.** While windows can be designed to resist the blast pressure effects of the exploding rounds, they cannot be economically designed to resist the fragment effects as well. Because of that, the approach in this UFC is to replace windows with window assemblies that are resistant to the blast pressure effects, and that are narrow so they minimize exposure to fragments instead of resisting them. Windows cannot be made economically to provide a high level of protection to any but the low threat severity level. In those cases, for the purposes of this UFC, the windows are eliminated and replaced by the same material as is used for the buildings' walls.

C-3.3.1.3 **Doors.** Building doors to resist both blast and fragments is very expensive and the resulting doors would not be easy to operate. Because of that, all doors for this tactic are backed up by foyers to both catch the failing door and to intercept the fragments. The foyer walls and roofs are of the same construction as the rest of the building.

C-3.3.1.4 **Roofs.** Conventional roofs are sufficient to resist the indirect fire weapons effects for only the low threat severity level. For all other threat severity levels, roof construction is based on a sacrificial roof of conventional construction at either 2 meters (6 feet) or 4 meters (12 feet) above reinforced concrete slab construction of increasing thickness. The sacrificial roof in each case uses the roof construction in the baseline construction as tabulated in Table C-2. Where the baseline construction is standing seam metal roof, the sacrificial roof needs to be hardened slightly using rigid foam insulation and corrugated steel deck.

C-3.3.1.5 **Wall Extensions.** The sacrificial roofs are held up by extended walls to ensure that rounds do not detonate beneath the sacrificial roofs. The wall extensions are of construction similar to that used for the hardened construction, but they are not as heavily reinforced and they may not be as thick.

C-3.3.2 **Existing Construction.**

C-3.3.2.1 **Walls.** Designing wall retrofits to resist the blast pressure and fragmentation effects is only economical at the lower levels of protection and lower threat severity levels. In those cases, walls retrofits are mostly those that were described above for blast resistant exterior construction. They also include adding steel plate to stop the fragment, however. Retrofits to higher threat severity levels and levels of protection are not included at all due to their impracticality.

C-3.3.2.2 **Windows.** Window retrofits involve replacing existing windows with new window assemblies. As for new construction, they only resist the blast pressure effects from the exploding rounds, and not the fragmentation. For buildings with masonry or concrete exteriors, the retrofits include concrete in-fill to minimize the size of the window opening so narrow windows can be installed.

C-3.3.2.3 **Doors.** Doors for retrofits use the same foyers as those for new construction.

C-3.3.2.4 **Roofs.** Roofs for retrofits involve removing the existing roofs and installing new roofs like those for new construction.

C-3.3.2.5 **Wall Extensions.** The wall extensions that support the sacrificial roofs use similar construction to that used for the hardened wall construction, but the wall extensions are not as heavily reinforced, may not be as thick, or may not include the retrofit that is applied to the hardened walls. The wall extensions only need to keep rounds from penetrating and detonating under the sacrificial roof.

C-3.4 **Construction to Resist Direct Fire Weapons.** Construction to mitigate the effects of direct fire weapons is in Table C-10 (new construction) and C-11 (retrofit construction). In both cases, the construction either obscures sightlines to assets (low level of protection) or provides resistance to the effects of the weapons (other levels of protection).

C-3.4.1 **Walls.** Other than the conventional construction to provide obscuration, the walls required to resist the weapons effects are either masonry or reinforced concrete for new construction. For retrofit construction, the walls have steel plate of varying thicknesses added.

C-3.4.2 **Windows.** Windows will be reflective (using fragment retention film or factory applied coatings) for the low level of protection. For the higher levels of protection they are provided only for bullet resistance and include varying thicknesses of laminated glass. The same windows are used for new and retrofit construction, assuming that windows will be replaced during major renovations. There will not be windows at the higher levels of protection for antitank weapons.

C-3.4.3 **Doors.** Doors at the low level of protection will be opaque to obscure sightlines. For the high level of protection for the threat severity levels that are limited to small arms, the doors will be bullet resistant assemblies for new construction and they will be retrofitted with steel plate for retrofit construction. For the higher levels of protection for the larger caliber bullets and the anti-tank weapons, doors are impractical, so conventional doors will be installed in shielded entry foyers.

C-3.4.4 **Roofs.** Roofs in this table are conventional construction based on the assumption that there are no direct fire sightlines to roofs. If there are such sightlines, additional cost will need to be added to account for using reinforced concrete for new construction or adding steel for retrofit construction.

C-3.5 **Construction to Mitigate Airborne Contamination.** The building elements associated with construction to mitigate airborne contamination are limited to enhancements to heating, ventilating, and air conditioning systems. They include increases in system air handling capacity and the addition of filters. Those elements are shown in Table C-12

C-3.6 **Construction to Mitigate Waterborne Contaminants.** Enhancements for waterborne contaminants are limited to water treatment and distribution system elements that are reflected in Table C-13.

C-3.7 **Construction to Mitigate Waterfront Attacks.** The construction enhancements for this tactic are addressed under blast resistant exterior construction and construction to resist direct fire weapons as applicable.

C-3.8 **Forced Entry Resistant Construction.** Construction to resist forced entry is tabulated in Tables C-14 and C-15. The construction includes materials and

assemblies that have been tested to provide forced entry resistance for specific time periods against a range of tools.

C-3.8.1 **Walls.** For new construction, walls are reinforced masonry or concrete with varying amounts of reinforcing steel or with the addition of expanded metal mesh. In the case of the varying reinforcement, the reinforcement is both vertical and horizontal and often consists of staggered meshes. For retrofitted walls, various combinations of steel and plywood are added to the existing walls.

C-3.8.2 **Windows.** Windows to resist forced entry, where possible, are laminated glass of varying thicknesses. The same windows are used for new and retrofit construction, assuming that windows will be replaced during major renovations.

C-3.8.3 **Doors.** Doors to resist forced entry have thick steel plate and may be filled with concrete or may include expanded metal meshes. Retrofit doors are similar, assuming doors can be replaced relatively easily during major retrofits.

C-3.8.4 **Roofs.** For new construction, roofs are reinforced concrete with varying levels of reinforcement and expanded metal as described for walls. For retrofit construction, similar additions are made to the roofs as are made to the walls.

C-3.9 **Covert Entry Construction.** There are no significant requirements for construction for mitigating covert entry. The requirements are limited to employing access control equipment and procedures with varying levels of sophistication. The specific equipment reflected in Table C-16 is described in detail in the *DoD Security Engineering Design Manual (UFC 4-011-02)*.

C-3.10 **Construction for Mitigating Acoustics Eavesdropping.** Construction to mitigate acoustics eavesdropping is tabulated in Table C-17. It includes considerations for the four major building components as follows:

C-3.10.1 **Walls.** Generally, conventionally constructed interior walls provide adequate attenuation of sound transmission to meet the requirements of all levels of protection. Common interior construction may require the installation of additional layers of gypsum wall board and emplacing insulation in the voids between studs. Retrofit construction effectively is only a consideration for interior walls. It involves removing gypsum wall board from one side of the existing wall, emplacing insulation inside the wall, and replacing the gypsum wall board.

C-3.10.2 **Doors.** Doors to provide sound transmission attenuation can either be conventional solid core wood doors with gaskets around them, which only apply to the low level of protection, or specially manufactured door assemblies designed to provide the applicable STC rating. For retrofits, the existing doors will have to be replaced with the same doors as are used for new construction.

C-3.10.3 **Windows.** Windows used in this manual for attenuating sound transmission are laminated glass of varying thicknesses and configurations insulating

glass with differing air space dimensions. For retrofit construction, the existing windows are removed and replaced with windows like those specified for new construction.

C-3.10.4 **Roofs.** Roofs are commonly adequate to attenuate sound transmission without modification. Ceilings are either varying thicknesses of reinforced concrete slab or combinations of gypsum wall board and insulation. One of the tabulated ceilings refers to channels on which the gypsum wall board is mounted. Those channels are light gage steel channels that are common to sound attenuating construction.

C-2.11 **Construction to Mitigate Electronic Emanations Eavesdropping.**

Construction to attenuate electronic emanations is very specialized. It involves installing steel sheets in walls, roofs, and ceilings and providing specially manufactured TEMPEST rated doors and windows. For retrofit construction, the doors and windows must be replaced with doors and windows like those used for new construction. Walls, roofs, and ceilings can have the steel sheets added to them, but the interior finish may have to be removed and replaced. There is no table in this appendix for building components associated with this tactic because the costs are too complex and site specific.

C-3.6 **Sitework Element Construction.** Barriers in Table C-18 are perimeter barriers, active barriers, or screens to either provide predetonation of antitank rounds or to shield assets from those weapons. The passive perimeter barriers are either chain link fence or concrete filled pipe bollards. In the case of the chain link fence, it is reinforced with cable except for in the case of the stationary vehicle bomb tactic where the only requirement is to ensure there is an obstacle to easy passage through the perimeter. In that case, the basic chain link fence is adequate for cost estimating purposes. For the active barriers the chain link gate is for the stationary vehicle bomb tactic. The others are tested to resist moving vehicle penetration. Specific models of active barriers were included in the table. They were chosen because they were representative of what is available on the market, and the selections include products from multiple manufacturers. Most manufacturers can provide a model of barrier to meet each requirement, and procurement should be through guide specifications. In the case of the screens, both are free standing and constructed adequately to withstand wind loads. The wood slat fence has posts in concrete footings and the wall has a foundation that extends to frost depth (at least 1 meter for cost estimating purposes.)

Table C-1. Guide to Construction Component Tables				
Tactic		New or Retrofit	Table	Page
None : Baseline Construction		Both	C-2	C-10
Blast Resistant Building Exterior Construction (25 kg explosives and higher)		New	C-3	C-11
		Retrofit	C-4	C-14
Hand Delivered Devices	Building exterior (IID, ≤ 1 kg explosives & hand grenades)	Both	C-5	C-15
	Building interior (IID, ≤ 1 kg explosives & hand grenades)	Both	C-6	C-16
	Building interior ≥ 25 kg explosives	Both	C-7	C-17
Indirect Fire Weapons		New	C-8	C-18
		Retrofit	C-9	C-20
Direct Fire Weapons		New	C-10	C-22
		Retrofit	C-11	C-23
Airborne Contamination		New	C-12	C-24
Waterborne Contamination		New	C-13	C-24
Forced Entry		New	C-14	C-25
		Retrofit	C-15	C-28
Covert Entry		Both	C-16	C-31
Visual Surveillance		Construction requirements are limited to installation of window treatments to block sight lines through windows.		
Acoustics Eavesdropping		Both	C-17	C-32
Electronic Emanations Eavesdropping		Requires TEMPEST shielded construction. Not covered in a table in this appendix due to specialized and sensitive nature of the technology.		
Sitework Elements		Both	C-18	C-33

Table C-2. Baseline Construction for Common Building Types				
Building Category	Building Component Construction			
	Walls	Doors	Windows	Roofs
288 Person Barracks (exterior entrances) (3 stories) (102,000 gross sf)	Concrete masonry unit (3.41%)*	3' X 7' Hollow metal and 6' X 7' glazed pairs (0.26%)*	Aluminum frame / sliding (0.86%)*	Standing seam metal (1.11%)*
288 Person Barracks (interior entrances) (3 stories) (115,000 gross sf)	Concrete masonry unit (3.44%)*	3' X 7' Hollow metal and 6' X 7' glazed pairs (2.12%)*	Aluminum frame / sliding (0.86%)*	Standing seam metal (1.19%)*
Dining Facility (1 story) (14,000 gross sf)	Brick veneer / metal stud (0.36%)*	Hollow metal and glazed, 3' X 7' & 6' X 7' pairs (0.84%)*	Aluminum frame / fixed (1.19%)*	Standing seam metal (2.00%)*
Administrative Facility (2 stories) (26,000 gross sf)	Brick veneer / metal stud (0.53%)*	Hollow metal and glazed, 3' X 7' & 6' X 7' pairs (0.74%)*	Aluminum frame / fixed, projected, & storefront (5.40%)*	Standing seam metal (1.73%)*
Medical Clinic (1 story) (40,000 gross sf)	Brick veneer / metal stud (0.25%)*	Hollow metal and glazed, 3' X 7' & 6' X 7' pairs (1.08%)*	Aluminum frame / fixed (0.81%)*	Built-up roofing (1.11%)*
Special Structures	Concrete masonry unit (0.25%)*	Hollow metal and glazed, 6' X 7' pairs (1.08%)*	Aluminum frame / fixed (0.81%)*	Standing seam metal (1.11%)*

* Note: Percentages shown are the percentages of baseline total building cost represented by each of the building components for conventional construction

Table C-3. Blast Resistant Building New Construction (for 25 kg TNT explosives and higher)		
Building Component	Construction Description	Construction Type
Walls	450 mm (18 in) heavily reinforced concrete	W
	450 mm (18 in) moderately reinforced concrete	V
	450 mm (18 in) lightly reinforced concrete	U
	300 mm (12 in) heavily reinforced concrete	T
	300 mm (12 in) moderately reinforced concrete	S
	300 mm (12 in) lightly reinforced concrete	R
	300 (12 in) mm heavily reinforced CMU	Q
	200 mm (8 in) heavily reinforced concrete	P
	250 mm (10 in) heavily reinforced CMU	O
	200 mm (8 in) moderately reinforced concrete	N
	200 mm (8 in) lightly reinforced concrete	M
	300 mm (12 in) moderately reinforced CMU	L
	150 mm (6 in) heavily reinforced concrete	K
	150 mm (6 in) moderately reinforced concrete	J
	150 mm (6 in) lightly reinforced concrete	I
	100 mm (4 in) heavily reinforced concrete	H
	100 mm (4 in) moderately reinforced concrete	G
	100 mm (4 in) lightly reinforced concrete	F
	250 mm (10 in) moderately reinforced CMU	E
	200 mm (8 in) heavily reinforced CMU	D
	300 mm (12 in) lightly reinforced CMU	C
	200 mm (8 in) moderately reinforced CMU	B
	200 mm (8 in) lightly reinforced CMU	A
Conventional construction	-	
Windows	2" (50 mm) Polycarbonate	J
	1.5" (38 mm) Polycarbonate	I
	1" (25 mm) Polycarbonate	H
	¾" (19 mm) Polycarbonate	G
	¼" (6 mm) + 7 x 1/8 in (3 mm) glass + 6 x 0.045 in (1mm) PVB	F
	¼" (6 mm) + 5 x 1/8 in (3 mm) glass + 4 x 0.045 in (1mm) PVB	E
	¼" (6 mm) + 4 x 5/32 in (4 mm) glass + 3 x 0.045 in (1mm) PVB	D
	¼" (6 mm) + 2 x 3/16 in (5 mm) glass + 0.060 in (1.5 mm) PVB	C
	¼" (6 mm) + 2 x 5/32 in (4 mm) glass + 0.060 in (1.5 mm) PVB	B
	¼" (6 mm) + 2 x 1/8 in (3 mm) glass + 0.030 in (0.75 mm) PVB	A
Doors	100 PSI (690 kPa) blast door	I
	50 PSI (345 kPa) blast door	H
	25 PSI (172kPa) blast door	G
	12 PSI (83 kPa) blast door	F
	10 PSI (69 kPa) blast door	E
	7 PSI (48 kPa)blast door	D
	4 PSI (28 kPa) blast door	C
	Hollow metal door with backing wall	B
	Hollow metal door	A

Table C-3 (continued)

Roofs		
	300 mm (12 in) heavily reinforced concrete	72
	300 mm (12 in) moderately reinforced concrete	71
	300 mm (12 in) lightly reinforced concrete	70
	225 mm (9 in) heavily reinforced concrete	69
	225 mm (9 in) moderately reinforced concrete	68
	225 mm (9 in) lightly reinforced concrete	67
	150 mm (6 in) heavily reinforced concrete	66
	150 mm (6 in) moderately reinforced concrete	65
	150 mm (6 in) lightly reinforced concrete	64
	100 mm (4 in) heavily reinforced concrete	63
	100 mm (4 in) heavily reinforced concrete	62
	100 mm (4 in) heavily reinforced concrete	61
	36LH15 L=60' (18.2 m) ;B=8' (2.4 m) with metal deck and 5.5" (150 mm) concrete	60
	32LH12 L=60' (18.2 m) ;B=6' (1.8 m) with metal deck and 4.5" (115 mm) concrete	59
	32LH09 L=60' (18.2 m) ;B=4' (1.2 m) with metal deck and 3.5" concrete	58
	30K12 L=60' (18.2 m);B=4' (1.2 m) with metal deck and 3.5" concrete	57
	30K12 L=60' (18.2 m);B=8' (2.4 m) with metal deck and 5.5" (150 mm) concrete	56
	30K12 L=60' (18.2 m);B=6' (1.8 m) with metal deck and 4.5" (115 mm) concrete	55
	32LH06 L=60' (18.2 m);B=4' (1.2 m) with metal deck	54
	30K9 L=60' (18.2 m);B=4' (1.2 m) with metal deck	53
	32LH07 L=60' (18.2 m);B=6' (1.8 m) with metal deck	52
	32LH09 L=60' (18.2 m);B=8' (2.4 m) with metal deck	51
	30K12 L=60' (18.2 m);B=6' (1.8 m) with metal deck	50
	30K12 L=60' (18.2 m);B=8' (2.4 m) with metal deck	49
	300 mm (12 in) heavily reinforced concrete	48
	300 mm (12 in) moderately reinforced concrete	47
	300 mm (12 in) lightly reinforced concrete	46
	225 mm (9 in) heavily reinforced concrete	45
	225 mm (9 in) moderately reinforced concrete	44
	225 mm (9 in) lightly reinforced concrete	43
	150 mm (6 in) heavily reinforced concrete	42
	150 mm (6 in) moderately reinforced concrete	41
	150 mm (6 in) lightly reinforced concrete	40
	100 mm (4 in) heavily reinforced concrete	39
	100 mm (4 in) moderately reinforced concrete	38
	100 mm (4 in) lightly reinforced concrete	37
	24LH11 L=40' (12.2 m);B=8' (2.4 m) with metal deck and 5.5" (150 mm) concrete	36
	20LH09 L=40' (12.2 m);B=6' (1.8 m) with metal deck and 4.5" (115 mm) concrete	35
	20LH05 L=40' (12.2 m);B=4' (1.2 m) with metal deck and 3.5" (90 mm) concrete	34
	30K12 L=40' (12.2 m);B=8' (2.4 m) with metal deck and 5.5" (150 mm) concrete	33
	30K12 L=40' (12.2 m);B=6' (1.8 m) with metal deck and 4.5" (115 mm) concrete	32

Table C-3 (continued)

Roofs (continued)	20K10 L=40' (12.2 m);B=4' (1.2 m) with metal deck and 3.5" (90 mm) concrete	31
	20LH02 L=40' (12.2 m);B=4' (1.2 m) with metal deck	30
	20LH04 L=40' (12.2 m);B=6' (1.8 m) with metal deck	29
	20K5 L=40' (12.2 m);B=4' (1.2 m) with metal deck	28
	20LH06 L=40' (12.2 m);B=8' (2.4 m) with metal deck	27
	20K10 L=40' (12.2 m);B=6' (1.8 m) with metal deck	26
	22K10 L=40' (12.2 m);B=8' (2.4 m) with metal deck	25
	300 mm (12 in) heavily reinforced concrete	24
	300 mm (12 in) moderately reinforced concrete	23
	300 mm (12 in) lightly reinforced concrete	22
	225 mm (9 in) heavily reinforced concrete	21
	225 mm (9 in) moderately reinforced concrete	20
	225 mm (9in) lightly reinforced concrete	19
	150 mm (6 in) heavily reinforced concrete	18
	150 mm (6 in) moderately reinforced concrete	17
	150 mm (6 in) lightly reinforced concrete	16
	100 mm (4 in) heavily reinforced concrete	15
	100 mm (4 in) heavily reinforced concrete	14
	100 mm (4 in) heavily reinforced concrete	13
	18LH08 L=30' (9.1 m);B=8' (2.4 m) with metal deck and 5.5" (150 mm) concrete	12
	18LH05 L=30' (9.1 m);B=6' (1.8 m) with metal deck and 4.5" (115 mm) concrete	11
	18LH02 L=30' (9.1 m);B=4' (1.2 m) with metal deck and 3.5" (90 mm) concrete	10
	30K12 L=30' (9.1 m);B=8' (2.4 m) with metal deck and 5.5" (150 mm) concrete	9
	16K7 L=30' (9.1 m);B=4' (1.2 m) with metal deck and 3.5" (90 mm) concrete	8
	20K10 L=30' (9.1 m);B=6' (1.8 m) with metal deck and 4.5" (115 mm) concrete	7
	18LH02 L=30' (9.1 m);B=4' (1.2 m) with metal deck	6
	18LH02 L=30' (9.1 m);B=6' (1.8 m) with metal deck	5
	16K2 L=30' (9.1 m);B=4' (1.2 m) with metal deck	4
	18LH02 L=30' (9.1 m);B=8' (2.4 m) with metal deck	3
	16K5 L=30' (9.1 m);B=6' (1.8 m) with metal deck	2
	16K9 L=30' (9.1 m);B=8' (2.4 m) with metal deck	1
	Conventional Construction	-

Table C-4. Blast Resistant Building Retrofit Construction (for 25 kg TNT explosives and higher)		
Building Component	Construction Description	Construction Type
Walls	Steel Stud Wall Retrofit	K
	150 mm (6 in) Bonded Reinforced Concrete Backer Wall (#3 reinforcing bars @ 150 mm (6 in))	J
	150 mm (6 in) Bonded Reinforced Concrete Backer Wall (#3 reinforcing bars @ 250 mm (10 in))	I
	150 mm (6 in) Unbonded Reinforced Concrete Backer Wall (#3 reinforcing bars @ 150 mm (6 in))	H
	100 mm (4 in) Bonded Reinforced Concrete Backer Wall (#3 reinforcing bars @ 300 mm (12 in))	G
	150 mm (6 in) Unbonded Reinforced Concrete Backer Wall (#3 reinforcing bars @ 250 mm (10 in))	F
	100 mm (4in) Unbonded Reinforced Concrete Backer Wall (#3 reinforcing bars @ 300 mm (12 in))	E
	High Capacity Wall Catcher System	D
	Geotextile fabric catcher system (Comtrac R 500)	C
	Geotextile fabric catcher system (HS 1715)	B
	Geotextile fabric catcher system (HS 800)	A
	Conventional construction	-
	Windows	2" (50 mm) Polycarbonate
1.5" (38 mm) Polycarbonate		G
¼" (6 mm) + 7 x 1/8 in (3 mm) glass + 6 x 0.045 in (1mm) PVB		F
¼" (6 mm) + 5 x 1/8 in (3 mm) glass + 4 x 0.045 in (1mm) PVB		E
¼" (6 mm) + 4 x 5/32 in (4 mm) glass + 3 x 0.045 in (1mm) PVB		D
¼" (6 mm) + 2 x 3/16 in (5 mm) glass + 0.060 in (1.5 mm) PVB		C
¼" (6 mm) + 2 x 5/32 in (4 mm) glass + 0.060 in (1.5 mm) PVB		B
¼" (6 mm) + 2 x 1/8 in (3 mm) glass + 0.030 in (0.75 mm) PVB		A
Doors	Metal Door Retrofit	B
	Hollow Metal Door	A
Roofs	225 mm (9 in) heavily reinforced concrete slab	18
	225 mm (9 in) moderately reinforced concrete slab	17
	225 mm (9 in) lightly reinforced concrete slab	16
	24LH11 L=40' (12.2 m); B=8' (2.4 m) with metal deck and 5.5" (140 mm) concrete	15
	20LH09 L=40' (12.2 m); B=6' (1.8 m) with metal deck and 4.5" (115 mm) concrete	14
	20LH05 L=40' (12.2 m); B=4' (1.2 m) with metal deck and 3.5" (90 mm) concrete	13
	20K10 L=40' (12.2 m); B=4' (1.2 m) with metal deck and 3.5" (90 mm) concrete	12
	20LH02 L=40' (12.2 m); B=4' (1.2 m) with metal deck	11
	20K10 L=40' (12.2 m); B=6' (1.8 m) with metal deck	10
	22K10 L=40' (12.2 m); B=8' (2.4 m) with metal deck	9
	225 mm (9 in) heavily reinforced concrete slab	8
	225 mm (9 in) moderately reinforced concrete slab	7

Table C-4 (continued)

Roofs (continued)	18LH08 L=30' (9.1 m); B=8' (2.4 m) with metal deck and 5.5" (140 mm) concrete	6
	20K10 L=30' (9.1 m); B=6' (1.8 m) with metal deck and 4.5" (115 mm) concrete	5
	18LH02 L=30' (9.1 m); B=4' (1.2 m) with metal deck	4
	18LH02 L=30' (9.1 m); B=6' (1.8 m)	3
	18LH02 L=30' (9.1 m); B=8' (2.4 m)	2
	16K9 L=30' (9.1 m); B=8' (2.4 m)	1
	Conventional Construction	-

Table C-5. Hand Delivered Device Resistant Building Exterior Construction (for IID, hand grenades, and 1 kg TNT IID) New and Existing Construction		
Building Component	Construction Description	Construction Type
Walls	Conventional construction (no special requirements)	A
	High capacity wall catcher system retrofit	B
	100 mm (6-inch) lightly reinforced concrete	C
	100 mm (6-inch) concrete backing wall retrofit (#3 @ 300 mm (12 in))	D
Windows	¼ -inch (6 mm) laminated glass in accordance with minimum standards	A
	¾ -inch (19 mm) polycarbonate glazing	B
Doors	Conventional hollow metal doors	A
	Conventional hollow steel doors in 6-inch (150 mm) reinforced concrete entry foyers	B
Roofs	Conventional roof	A
	100 mm (6 - inch) lightly reinforced concrete	B

**Table C-6. Construction for Interior Spaces Subject to Explosions
Medium Threat Severity Level (1 kg)
New and Existing Construction**

Type of Space	Low LOP						Medium LOP						High LOP					
	Walls			Ceilings			Walls			Ceilings			Walls			Ceilings		
	Thickness (inches)	Horizontal Reinforcement	Vertical Reinforcement	Thickness (inches)	Horizontal Reinforcement	Vertical Reinforcement	Thickness (inches)	Horizontal Reinforcement	Vertical Reinforcement	Thickness (inches)	Horizontal Reinforcement	Vertical Reinforcement	Thickness (inches)	Horizontal Reinforcement	Vertical Reinforcement	Thickness (inches)	Horizontal Reinforcement	Vertical Reinforcement
Small Mail Rooms (10' x 20' x 10' High)	6	H	H	8	H	H	8	M	H	9	H	H	10	M	H	12	H	H
Medium Mail Rooms (16' x 25' x 10' High)	6	M	M	8	H	H	6	M	M	10	H	H	8	M	M	14	H	H
Large Mail Room (22' x 32' x 10' High)	6	M	M	8	H	H	6	M	H	10	H	H	6	H	H	14	H	M
Small Loading Dock (10' x 22' x 10' High)	6	M	M	8	H	H	6	M	H	8	H	H	8	H	H	12	M	M
Medium Loading Dock (10' x 34' x 10' High)	6	M	M	6	H	H	6	M	H	8	H	H	6	H	H	12	M	M
Large Loading Dock (22' x 46' x 10' High)	6	M	M	6	M	M	6	M	M	8	M	M	6	H	H	10	H	H
Small Entry Area (15' x 30' x 10' High)	6	M	M	6	H	H	6	M	M	8	H	H	6	M	H	12	M	M
Medium Entry Area (20' x 40' x 10' High)	6	M	M	6	M	M	6	M	M	8	H	H	6	M	H	12	H	H
Large Entry Area (40' x 50' x 10' High)	6	M	M	6	M	M	6	M	M	6	M	M	6	M	M	6	M	M

M = Moderate reinforcement ratio (0.25%)
H = Heavy reinforcement ratio (0.5%)

C-16

**Table C-7. Construction for Interior Spaces Subject to Explosions
High Threat Severity Level (25kg)
New and Existing Construction**

Type of Space	Low LOP						Medium LOP						High LOP					
	Walls			Ceilings			Walls			Ceilings			Walls			Ceilings		
	Thickness (inches)	Horizontal Reinforcement	Vertical Reinforcement	Thickness (inches)	Horizontal Reinforcement	Vertical Reinforcement	Thickness (inches)	Horizontal Reinforcement	Vertical Reinforcement	Thickness (inches)	Horizontal Reinforcement	Vertical Reinforcement	Thickness (inches)	Horizontal Reinforcement	Vertical Reinforcement	Thickness (inches)	Horizontal Reinforcement	Vertical Reinforcement
Small Mail Room (10' x 20' x 10' High)	Maximum explosive applied to mail rooms is 1 kg. See Table C-6																	
Medium Mail Room (16' x 25' x 10' High)																		
Large Mail Room (22' x 32' x 10' High)																		
Small Loading Dock (10' x 22' x 10' High)	24	M	M	26	H	H	28	M	M	32	H	H	32	M	M	39	H	H
Medium Loading Dock (10' x 34' x 10' High)	20	M	H	22	H	H	24	M	H	27	H	H	30	M	M	36	H	H
Large Loading Dock (22' x 46' x 10' High)	16	H	H	20	H	H	20	M	H	26	H	H	24	M	H	36	H	H
Small Entry Area (15' x 30' x 10' High)	14	M	M	14	H	H	16	M	H	20	H	H	22	M	M	26	H	H
Medium Entry Area (20' x 40' x 10' High)	14	M	H	18	H	H	16	H	H	22	H	H	22	M	H	32	H	H
Large Entry Area (40' x 50' x 10' High)	10	H	H	20	H	H	12	H	H	26	H	H	15	M	H	36	H	H
M = Moderate reinforcement ratio (0.25%) H = Heavy reinforcement ratio (0.5%)																		

C-17

Table C-8. Indirect Fire Weapons Resistant Building Construction (New Construction)		
Building Component	Construction Description	Construction Type
Walls	150 mm (6 in) steel stud wall at 300 mm (12 in.) o.c. with brick veneer	A
	200 mm (8 in) lightly reinforced CMU	B
	200 mm (8 in) moderately reinforced CMU	C
	100 mm (4 in) lightly reinforced concrete	D
	300 mm (12 in) lightly reinforced concrete	E
	600 mm (24 in) lightly reinforced concrete	F
	450 mm (18 in) heavily reinforced concrete	G
	1400 mm (56 in) moderately reinforced concrete	H
Wall Extensions	150 mm (6 in) steel stud wall at 300 mm (12 in.) o.c. with brick veneer	A
	200 mm (8 in) lightly reinforced CMU	B
	100 mm (4 in) lightly reinforced concrete	C
Windows	6 mm (1/4 in) + 2 x 3 mm (1/8 in) glass with 0.75 mm (0.030 in) PVB in narrow window	A
	6 mm (1/4 in) + 4 x 3 mm (1/8 in) glass with 3 x 1 mm (0.045 in) PVB in narrow window	B
	No window – use wall material as in fill	C
Doors	Doors in entry foyer using same construction as rest of building (walls, wall extensions, hardened roof, sacrificial roof)	A
Hardened Roofs	Standing seam metal roof + 50 mm (2 in) extruded polystyrene insulation + 50 mm (2 in) corrugated steel deck	1
	150 mm (6 in) moderately reinforced concrete (1.5 m / 5 ft span – 2 m / 6 ft high)	2
	225 mm (9 in) lightly reinforced concrete (1.5 m / 5 ft. span)	3
	225 mm (9 in) lightly reinforced concrete (3.8 m / 12.5 ft. span)	4
	225 mm (9 in) lightly reinforced concrete (6 m / 20 ft. span)	5
	225 mm (9 in) moderately reinforced concrete (1.5 m / 5 ft. span)	6
	225 mm (9 in) moderately reinforced concrete (3.8 m / 12.5 ft. span)	7
	225 mm (9 in) moderately reinforced concrete (6 m / 20 ft. span)	8

Table C-8 (continued)

Hardened Roofs (continued)	225 mm (9 in) heavily reinforced concrete (6 m / 20 ft. span)	9
	300 mm (12 in) moderately reinforced concrete (6 m / 20 ft. span)	10
	300 mm (12 in) heavily reinforced concrete (6 m / 20 ft. span)	11
Sacrificial Roofs	Conventional built up roofing at 2 m (6 ft)	1
	Conventional built up roofing at 4 m (12 ft)	2
	Standing seam metal roof + 50 mm (2 in) extruded polystyrene insulation + 50 mm (2 in) corrugated steel deck at 2 m (6 ft)	3
	Standing seam metal roof + 50 mm (2 in) extruded polystyrene insulation + 50 mm (2 in) corrugated steel deck at 4 m (12 ft)	4

Table C-9. Indirect Fire Weapons Resistant Building Construction (Existing Construction)		
Building Component	Construction Description	Construction Type
Walls	Add steel studs between existing studs in existing steel stud wall (with brick veneer)	A
	100 mm (4 in) unbonded lightly reinforced concrete backing wall	B
	150 mm (6 in) unbonded lightly reinforced concrete backing wall	C
	150 mm (6 in) unbonded moderately reinforced concrete backing wall	D
	Steel stud wall retrofit	E
	Steel stud wall retrofit with 50 mm (2 in) steel plate	F
Wall Extensions	150 mm (6 in) steel stud wall at 300 mm (12 in.) o.c. with brick veneer	A
	200 mm (8 in) lightly reinforced CMU	B
Windows	1/4" (6 mm) + 2 x 1/8 in (3 mm) glass + 0.030 in (0.75 mm) PVB narrow window with wall in fill	A
Doors	Doors in entry foyer using same construction as rest of building (walls, wall extensions, hardened roof, sacrificial roof)	A
Hardened Roofs	Standing seam metal roof + 50 mm (2 in) extruded polystyrene insulation + 50 mm (2 in) corrugated steel deck	1
	150 mm (6 in) moderately reinforced concrete (1.5 m / 5 ft span - 2 m / 6 ft high)	2
	225 mm (9 in) lightly reinforced concrete (1.5 m / 5 ft. span)	3
	225 mm (9 in) lightly reinforced concrete (3.8 m / 12.5 ft. span)	4
	225 mm (9 in) lightly reinforced concrete (6 m / 20 ft. span)	5
	225 mm (9 in) moderately reinforced concrete (1.5 m / 5 ft. span)	6
	225 mm (9 in) moderately reinforced concrete (3.8 m / 12.5 ft. span)	7
	225 mm (9 in) moderately reinforced concrete (6 m / 20 ft. span)	8
	225 mm (9 in) heavily reinforced concrete (6 m / 20 ft. span)	9
	300 mm (12 in) moderately reinforced concrete (6 m / 20 ft. span)	10

Table C-9 (continued)

Hardened Roofs (continued)	300 mm (12 in) heavily reinforced concrete (6 m / 20 ft. span)	11
Sacrificial Roofs	Conventional built up roofing at 2 m (6 ft)	1
	Standing seam metal roof + 50 mm (2 in) extruded polystyrene insulation + 50 mm (2 in) corrugated steel deck at 2 m (6 ft)	2

Table C-10. Direct Fire Weapons Resistant Building Construction (New Construction)		
Building Component	Construction Description	Construction Type
Walls	No special construction (opaque)	A
	4-inch fully grouted concrete masonry unit or 4-inch clay brick	B
	6-inch fully grouted concrete masonry unit	C
	8-inch fully grouted concrete masonry unit	D
	24-inch thick reinforced concrete	E
Windows	4-mil reflective fragment retention film	A
	1/4 inch laminated glass in accordance with DoD minimum antiterrorism standards	B
	1/2 inch laminated tempered glass, 1/4 inch air gap and 3/4 inch glass clad polycarbonate (1/2 inch polycarbonate with 1/4 inch tempered glass on inside face)	C
	3/4 inch laminated tempered glass, 1/4 inch air gap and 1-3/16 inch glass clad polycarbonate (15/16 inch polycarbonate with 1/4 inch tempered glass on inside face)	D
	1-5/8 inch laminated annealed glass and 1/4 inch polycarbonate (1/4 inch polycarbonate with 1/4 inch tempered glass on inside face)	E
Doors	Standard hollow metal door	A
	Industrial door (3 foot by 7 foot) with interior 1/4 inch thick steel armor plate	B
	Industrial door (3 foot by 7 foot) with interior 7/16 inch thick steel armor plate	C
	Industrial door (3 foot by 7 foot) with interior 11/16 inch thick steel armor plate	D
	Doors shielded with 24-inch reinforced concrete walls	E
Roofs	No special roof construction (opaque)	A
	20K10 L=30' (9.1 m);B=6' (1.8 m) with metal deck and 4.5" (115 mm) concrete	B
	30K12 L=40' (12.2 m);B=6' (1.8 m) with metal deck and 4.5" (115 mm) concrete	C
	30K12 L=60' (18.2 m);B=6' (1.8 m) with metal deck and 4.5" (115 mm) concrete	D
	225 mm (9in) lightly reinforced concrete	E
	600 mm (24 in) lightly reinforced concrete	F

Table C-11. Direct Fire Weapons Resistant Building Construction (Retrofit Construction)		
Building Component	Construction Description	Construction Type
Walls	No special construction (opaque)	A
	5/16 mild steel plate	B
	9/16 mild steel plate	C
	13/16 mild steel plate	D
Windows	4-mil reflective fragment retention film	A
	1/2 inch laminated tempered glass, 1/4 inch air gap and 3/4 inch glass clad polycarbonate (1/2 inch polycarbonate with 1/4 inch tempered glass on inside face)	B
	3/4 inch laminated tempered glass, 1/4 inch air gap and 1-3/16 inch glass clad polycarbonate (15/16 inch polycarbonate with 1/4 inch tempered glass on inside face)	C
	1-5/8 inch laminated annealed glass and 1/4 inch polycarbonate (1/4 inch polycarbonate with 1/4 inch tempered glass on inside face)	D
Doors	Standard hollow metal door	A
	Industrial door (3 foot by 7 foot) with interior 1/4 inch thick steel armor plate	B
	Industrial door (3 foot by 7 foot) with interior 7/16 inch thick steel armor plate	C
	Industrial door (3 foot by 7 foot) with interior 11/16 inch thick steel armor plate	D
Roofs	No special roof construction (opaque)	A
	UL Level 3 ballistics rated fiberglass	B
	UL Level 5 ballistics rated fiberglass	C

Table C-12. HVAC Requirements for Airborne Contamination				
Level of Protection	HEPA filtration	HEPA and carbon filtration for outside air	HEPA and carbon filtration for all supply air	Overpressurization
Low	X			
Medium		X		X
High			X	X
Note: Overpressurization based on 0.25 cfm /ft ² plus exhaust				

Table C-13. Water Treatment Requirements for Waterborne Contamination					
Level of Protection	Superchlorination	Micro-filtration	Carbon filtration	Chlorination	Reverse Osmosis
Low	X				
Medium		X	X	X	
High		X	X	X	X

Table C-14. Forced Entry Resistant Building Construction (New Construction)		
Building Component	Construction Description	Construction Type
Walls	4-inch, solid-core, filled and reinforced masonry construction with interior wall system	A
	8-inch, solid-core, filled concrete masonry with #3 bars at 8 inches on center each way	B
	8-inch, solid-core, filled concrete masonry with #5 bars at 8 inches on center each way	C
	8-inch, mortar-filled concrete block with #6 bars at 8 inches on center each way	D
	8-inch, reinforced concrete with # 4 bars at 6 inches on center each way	E
	12-inch, mortar-filled, concrete block with #6 bars at 8 inches on center each way	F
	8-inch, solid-core, filled concrete masonry with #6 bars at 4 inches on center vertically and 8 inches on center horizontally	G
	12-inch, reinforced concrete with # 5 bars at 6 inches on center each way	H
	12-inch, reinforced concrete with 2 layers of #5 bars at 6 inches on center each way	I
	12-inch, reinforced concrete with 2 layers of # 7 bars at 4 inches on center each way	J
	12-inch, reinforced concrete with 5/16 expanded metal 2½ inches on center (4 layers)	K
	12-inch, reinforced concrete with 5/16-inch, expanded, metal mesh at 2½ inches on center and a ¼-inch backing plate	L
	18-inch-thick reinforced concrete with 5/16-inch expanded metal at 2½ inches on center and a ¼-inch backing plate	M
Windows	11/16-inch, glass-clad with 3/8-inch polycarbonate core	A
	13/16-inch, glass-clad with ½-inch polycarbonate core	B
	15/16-inch, glass-clad with 3/4-inch polycarbonate core	C

Table C-14 (continued)

Doors	Standard 16-gage, hollow, metal door (3 feet by 7 feet) with hinge-side protection, anti-pry strip, and drill-resistant dead bolt lock	A
	12-gage, hollow, metal door (3 feet by 7 feet) with hinge-side protection, anti-pry strip, and drill-resistant dead bolt lock	B
	12-gage, hollow, metal door with hinge-side protection, anti-pry strip, drill-resistant dead bolt lock, and filled with lightweight fireproofing	C
	12-gage, hollow, metal door filled with lightweight concrete (3 feet by 7 feet) with hinge-side protection, anti-pry strip, and drill-resistant dead bolt lock	D
	12-gage, hollow, metal door (3 feet by 7 feet) with hinge-side protection, anti-pry strip, drill-resistant dead bolt lock, and multipoint (3) locking	E
	Swinging door (6 inches thick) with ½-inch plate inside and out, lightweight concrete fill, and an internal locking system	F
	Sliding door (6 inches thick) filled with lightweight concrete that has been reinforced with expanded metal mesh with a ¾-inch steel front plate, ¼-inch back plate, and an internal locking system	G
	Swinging door (10 inches thick) with ½-inch plate inside and out	H
	Swinging door (10 inches thick) with ½-inch plate inside and out, lightweight concrete fill, and an internal locking system	I
	Swinging door (10 inches thick) with ½-inch plate inside and out, lightweight concrete fill reinforced with expanded metal mesh, and an internal locking system	J
	Swinging door (10 inches thick) with ½-inch plate inside and out, lightweight concrete fill reinforced with expanded metal mesh, and an internal locking system with a welded C-steel grating vestibule around the door for standoff protection	K

Table C-14 (continued)

Roofs	Built-up roof with gravel and rigid insulation on steel decking	A
	Built-up roof with gravel and rigid insulation and 2.5-inch lightweight concrete on steel decking	B
	Built-up roof with gravel and rigid insulation and 4-inch lightweight concrete with #5 bars at 8 inches on center each way on steel decking	C
	6-inch, reinforced concrete with #4 bars at 8 inches on center each way on steel decking and with built-up roofing	D
	6-inch, reinforced concrete with # 4 bars at 6 inches on center each way on steel decking and with a built-up roofing system	E
	8-inch, reinforced concrete with #4 bars at 8 inches on center each way on steel decking and with built-up roofing	F
	4-inch, reinforced concrete with 6 by 6 welded wire mesh, 10-gage reinforcing on steel decking and a built-up roofing system	G
	6-inch, reinforced concrete with 6 by 6 welded wire mesh, 10-gage reinforcing on steel decking and a built-up roofing system	H
	10-inch, reinforced concrete with # 5 bars at 6 inches on center each way on steel decking and with a built-up roof	I
	10-inch, reinforced concrete with 2 layers of #5 bars at 6 inches on center each way on steel decking and with a built-up roofing system	J
	10-inch, reinforced concrete with 5/16 expanded metal 2½ inches on center on steel decking with a built-up roofing system	K
	12-inch, reinforced concrete with 2 layers of # 7 bars at 4 inches on center each way on steel decking and built-up roofing	L
	10-inch, reinforced concrete with 5/16-inch, expanded, metal mesh at 2½ inches on center with ¼-inch decking and a built up roofing system	M
	12-inch-thick, reinforced concrete with 5/16-inch expanded metal at 2½ inches on center, ¼-inch steel decking, and built-up roofing	N

Table C-15. Forced Entry Resistant Building Construction (Retrofit Construction)		
Building Component	Construction Description	Construction Type
Walls	Add ¾-inch plywood to the inside face	A
	Add #5 bars at 8 inches on center reinforcing or grating to the inside face between exterior and interior walls.	B
	Add 9-gage, expanded, metal mesh between existing exterior and interior wall systems	C
	Add 9-gage sheet metal between existing exterior and interior wall systems	D
	Add ¼-inch steel plate between existing exterior and interior wall systems	E
	Add 3-layer (10-gage steel/ ¾-inch plywood/10-gage steel), steel-plywood system between existing exterior and interior wall systems	F
	Add 5-layer (10-gage steel/ ¾-inch plywood/10-gage steel/ ¾-inch plywood/10-gage steel) steel-plywood system between existing interior and exterior wall systems.	G
	Add 7-layer (10-gage steel/ ¾-inch plywood/10-gage steel/ ¾-inch plywood/10-gage steel/ ¾-inch plywood/10-gage steel) steel-plywood system between existing interior and exterior wall systems	H
Windows	11/16-inch, glass-clad with 3/8-inch polycarbonate core	A
	13/16-inch, glass-clad with ½-inch polycarbonate core	B
	15/16-inch, glass-clad with ¾-inch polycarbonate core	C
Doors	Standard 16-gage, hollow, metal door (3 feet by 7 feet) with hinge-side protection, anti-pry strip, and drill-resistant dead bolt lock	A
	A vestibule outside entrance door, designed to resist explosive effects, must be provided to force two explosive attempts	B
	12-gage, hollow, metal door (3 feet by 7 feet) with hinge-side protection, anti-pry strip, and drill-resistant dead bolt lock	C

Table C-15 (continued)

Doors (continued)	12-gage, hollow, metal door (3 feet by 7 feet) with hinge-side protection, anti-pry strip, and drill-resistant dead bolt lock and filled with lightweight fireproofing	D
	Steel door with ¼-inch inner and outer face (3 feet x 7 feet) with hinge-side protection, anti-pry strip, drill-resistant dead bolt lock, and multipoint (3) locking	E
	Sliding door (6 inches thick) filled with lightweight concrete that has been reinforced with expanded metal mesh with a ¾-inch steel front plate, ¼-inch back plate, and an internal locking system	F
	Swinging door (6 inches thick) with ½-inch plate inside and out, lightweight concrete fill, and an internal locking system	G
	Swinging door (10 inches thick) with ½-inch plate inside and out	H
	Swinging door (10 inches thick) with ½-inch plate inside and out, lightweight concrete fill, and an internal locking system	I
	Swinging door (10 inches thick) with ½-inch plate inside and out, lightweight concrete fill reinforced with expanded metal mesh, and an internal locking system	J
	Roofs	Built-up roof with gravel and rigid insulation on steel decking
Add ¾-inch plywood and built-up roofing on top of existing metal seam construction		B
Install #5 bar 8 inches on center square grid under existing roof construction.		C
Add 9-gage, expanded, metal mesh on top of existing roof system, then resurface		D
Add 9-gage, steel sheet on top of existing roofing system, then resurface		E
Install ¼-inch steel plate on top of existing roofing system, and then resurface.		F
Add 3-layer (10-gage steel/ ¾-inch plywood/10-gage steel), steel-plywood system under the existing roof system		G
Add 3-layer (10-gage steel/ ¾-inch plywood/10-gage steel), steel-plywood system on top of existing roof system, then resurface		H

Table C-15 (continued)

Roofs (continued)	Add 5-layer (10-gage steel/ 3/4-inch plywood/10-gage steel/ 3/4-inch plywood/10-gage steel), steel-plywood system on top of existing roof, and then resurface.	I
	Add 7-layer (10-gage steel/ 3/4-inch plywood/10-gage steel/ 3/4-inch plywood/10-gage steel/ 3/4-inch plywood/10-gage steel) steel-plywood system on top of existing roof, and then resurface	J

Table C-16. Access Control Equipment for Covert Entry Tactic

Threat Severity Level	Equipment Set	Level of Protection	Equipment												
			Electric Strike Lock	Mag. Lock	Card Reader	PIN Reader	Shielded PIN Reader	Biometric Device	Portal Counter Turnstile	Person-trap	IDS on Operable Openings	Motion Sensor in Information	CCTV	Metal Detector	
Very High	P	Very High						X			X	X	X	X	X
	O	High					X			X		X	X	X	X
	N	Medium		X			X		X			X			
	M	Low		X			X		X						
High	L	Very High						X			X	X	X	X	X
	K	High					X			X		X	X	X	X
	J	Medium		X			X		X			X			
	I	Low		X			X		X						
Medium	H	Very High		X				X				X	X	X	
	G	High		X			X					X	X	X	
	F	Medium		X			X					X			
	E	Low		X			X								
Low	D	Very High		X	X	X		X				X	X	X	
	C	High		X	X							X	X	X	
	B	Medium		X		X						X			
	A	Low	X												

Note: No special construction is required for this tactic
 NR = Not required

C-31

11 September 2008

UFG 4-020-01

**Table C-17. Construction for Acoustics Eavesdropping Tactic
(New and Existing Construction)**

Building Component	Construction Description	Construction Type
Walls	Conventional construction	A
	Steel studs with gypsum wallboard both sides and insulation in cavity	B
	Steel studs with 2 layers of gypsum wallboard on one side and one on the other with insulation in cavity	C
Windows	6 mm (1/4 inch) laminated glass	A
	Insulated glass window with 10 mm (3/8 inch) laminated glass inside, 6 mm (1/4 inch) laminated glass outside, 12 mm (1/2 inch) airspace	B
	Insulated glass window with 6 mm (1/4 inch) laminated glass inside, 6 mm (1/4 inch) laminated glass outside, 50 mm (2 inch) airspace	C
	Insulated glass window with 12 mm (1/2 inch) laminated glass inside, 5 mm (3/16 inch) laminated glass outside, 100 mm (4 inch) airspace	D
Doors	Conventional solid core wood or insulated steel door with gaskets	A
	Specially manufactured STC 40 rated door	B
	Specially manufactured STC 45 rated door	C
	Specially manufactured STC 50 rated door	D
Ceilings / Roofs	Conventional construction	A
	Wood joists with 2 layers of plywood subfloor gypsum wallboard underneath	B
	100 mm (4 inch) reinforced concrete	C
	Wood joists with 2 layers of plywood subfloor gypsum wallboard suspended on channels underneath	D
	150 mm (6 in) (6 inch) reinforced concrete	E
	Wood or steel joists with gypsum wall board and insulation in cavities	F
	Wood or steel joists with 2 layers of gypsum wallboard and insulation in cavities	G

Table C-18. Sitework Element Construction

Barrier Category	Barrier Construction	Construction Type
Passive Perimeter	Standard 8-foot high, (7-foot fabric) 9 gage steel chain link fence with outrigger	A
	Standard chain link fence with a single ¾-inch cable anchored every 200 feet; allows 20- to 40-foot penetration into site	B
	Standard chain link fence with two ¾-inch cables anchored every 200 feet; allows 20- to 40-foot penetration into site	C
	Standard chain link fence with three ¾-inch cables anchored every 200 feet; allows 20- to 40-foot penetration into site	D
	8-inch diameter, concrete-filled bollards at 3 feet on center; penetration into site 0 to 3 feet	E
	8-inch diameter, concrete-filled bollards at 2 feet on center; penetration into site 0 to 3 feet	F
	8-inch diameter, concrete-filled bollards at 2 feet on center with 12-inch channel rail; penetration into site 3 to 20 feet	G
Active	Standard chain link gate	H
	Barriers similar to the ARMR Model 712 cable crash beam barrier or the Delta Scientific Model TT212 crash tested and shown to stop 40 K foot-pounds of kinetic energy	I
	Barriers similar to the Nasatka Model XI or the Delta Scientific Model TT203 crash tested and shown to stop 350 K foot-pounds of kinetic energy	J
	Barriers similar to the Nasatka Model VII or the Delta Scientific Model TT210 have been crash tested and shown to stop 450 K foot-pounds of kinetic energy	K
	Barriers similar to the Nasatka Model IIIb or the Delta Scientific Model TT207 crash tested and shown to stop 1.2 M foot-pounds of kinetic energy	L
	Barriers similar to the Nasatka Model V or Delta Scientific Model TT207 (S) have been crash tested and shown to stop 1.2 M foot-pounds of kinetic energy	M
	No commercial active barriers available that have been tested at this level of impact; however, basic construction of standard vehicles makes them vulnerable to barrier systems recommended for the very high threat severity level. Penetration of the disabled vehicle into the site could exceed requirements at this level	N
Screen	¾ -inch wood slat fence predetonation screen x 8 feet high	O
	2-foot thick reinforced concrete shielding wall x 8 feet high	P
Note: All active vehicle barriers may allow vehicle penetration of 3 to 20 feet.		

This page intentionally left blank

APPENDIX D

EXPEDITIONARY CONSTRUCTION COSTS

D-1 **INTRODUCTION.** The purpose of the table in this appendix is to provide planning level estimates of costs to incorporate countermeasures for security and antiterrorism into expeditionary and temporary construction.

D-2 **FORMULATION.** While the tables in Appendices A and B tabulate cost increases over the cost of new construction, that approach is not realistic for expeditionary construction due to the fact that there is no DoD-wide data base of expeditionary construction the way there is for permanent new construction. Expeditionary construction is not done as commonly as permanent new construction and the nature of expeditionary construction is that its cost varies significantly depending on who is building it and where it is being built. Because of the wide variability of this construction, the costs are tabulated here as actual costs of labor, materials, and equipment. In addition, the number of man-hours necessary to do the construction is tabulated. These costs can be used on a relative basis by comparing them to known costs of labor, materials, and equipment in the location where cost is being estimated or by using area cost factors as tabulated in the *DoD Facilities Pricing Guide (UFC 4-701-05)*.

D-3 **USING THE TABLE.** To use Table D-1, determine the countermeasure that is needed to mitigate a threat and the quantity of that component that is required. The costs shown for materials, labor, and equipment are in dollars per man-hour of installation time. The installation time is shown in man-hours per unit of measure. To determine the total cost of installing a given countermeasure, sum the applicable material, labor, and equipment costs per unit of measure and multiply that sum by the quantity of units required. The costs tabulated are for an area cost factor of one. They will need to be adjusted to reflect differences in costs of construction in other areas using either the area cost factors in the *DoD Facilities Pricing Guide (UFC 4-701-05)* or known costs for materials, labor, and equipment in the area. The installation time requirements are in man-hours per unit. To calculate the amount of time required for installation in terms of man-hours, multiply the number of units required by the installation number.

The cost and installation time would be calculated as follows:

- Cost = Units x (Materials + Labor + Equipment)
- Installation Time = Units x Installation

D-4 **EXAMPLE.** A base camp needs to be surrounded by one mile (5280 feet) of triple standard concertina fence and a counter mobility berm. There also need to be four entry lanes with motorized gates. The costs and installation times would be as follow:

- Triple Standard Concertina Fence:
Cost = 5280 lf x (\$9.00/lf + \$0.95/lf + \$0.00/lf) = \$52,536
Installation Time = 5280 lf x 0.03 mh/lf = 158.4 man-hours

- Freestanding Soil Berm (6 ft High):
Cost = 5280 lf x (\$0.00/lf + \$11.00/lf + \$17.60/lf) = \$151,008
Installation Time = 5280 lf x 0.3 mh/lf = 1584 man-hours
- Fence Gate (12 ft, One Lane):
Cost = 4 lanes x (\$530.00/lane + \$630.00/lane + \$310.00/lane) = \$5,880
Installation Time = 4 lanes x 20.4 mh/lane = 81.6 man-hours
- Mechanical Fence Gate Operator (12 ft, One Lane):
Cost = 4 lanes x (\$1,560.00/lane + \$520.00/lane + \$240.00/lane) = \$9,280
Installation Time = 4 lanes x 17 mh/lane = 68 man-hours
- Total Cost: \$ 218,704

D-5 **RECORDING THE COST.** How costs are recorded for expeditionary construction is widely variable depending on the operation and the funds source. Follow guidance established for the applicable operation.

Table D-1. Expeditionary Costs

Expedient Passive Defense Measure	Unit	Installation (M.H/Unit)	Materials (\$/Unit)	Labor (\$/Unit)	Equipment (\$/Unit)
Signage					
Warning Signs	Ea	0.20 mh	\$26.00	\$6.00	\$5.00
Physical Barriers					
Traffic Barricades	Ea	0.10 mh	\$87.00	\$4.00	\$0.00
Plastic Safety Fence	Lf	0.03 mh/lf	\$1.44	\$0.40	\$0.00
Ornamental Steel Fence	Lf	0.16 mh/lf	\$24.00	\$5.00	\$2.30
Ornamental Wood Fence	Lf	0.15 mh/lf	\$13.10	\$4.60	\$0.00
Triple Standard Concertina Fence	Lf	0.03 mh/lf	\$9.00	\$0.95	\$0.00
Barbed Tape Concertina Double Coil	Lf	0.05 mh/lf	\$3.40	\$0.95	\$0.00
Barbed Wire Fence	Lf	0.025 mh/lf	\$0.40	\$0.75	\$0.00
Chain Link Fence	Lf	0.17 mh/lf	\$9.10	\$5.25	\$2.70
Chain Link Fence (Sensor Ready)	Lf	0.18 mh/lf	\$8.75	\$5.55	\$2.70
Fence Gate (Personnel)	Ea	3.7 mh	\$145.00	\$110.00	\$75.00
Fence Gate (12-Ft One Lane)	Ea	20.4 mh	\$530.00	\$630.00	\$310.00
Fence Gate (20-Ft Two Lane)	Ea	25.6 mh	\$675.00	\$790.00	\$385.00
Mechanical Fence Gate Operator (12-Ft One Lane)	Ea	17mh	\$1,560.00	\$520.00	\$240.00
Mechanical Fence Gate Operator (20-Ft Two Lane)	Ea	17mh	\$2,800.00	\$520.00	\$240.00
Obscuration And Predetonation Screens					
Fence Obscuration	Lf	0.18 mh/lf	\$3.40	\$4.60	\$0.00
Camouflage Netting	Lf				
Plywood Obscuration Panel (12 Ft Tall)	Lf	0.4 mh/lf	\$17.60/lf	\$13.15/lf	0.80/lf
Wood Pole And Plank Wall (20 Ft Tall)	Lf	1 mh/lf	\$50.00	\$31.00	\$3.25
10-In CMU Wall (14 Ft Tall)	Lf	2.5 mh/lf	\$99.00	\$82.00	\$27.50
10-In Cast-In-Place Concrete Wall (16-Ft Tall)	Lf	3.4 mh/lf	\$54.30	\$133.50	\$6.80
Precast Concrete Panels With Steel Columns (15 Ft Tall)	Lf	2.25 mh/lf	\$209.00	\$99.00	\$32.00
Shipping Containers (20 Ft By 8 Ft By 8 Ft)	Ea	0.5 mh	\$0.00	\$15.40	\$154/mo
Parked Semi-Trailers With Plywood Skirt	Ea	1.4 mh	\$360.00	\$43.20	\$1980/mo
Revetments					
Sandbag Wall (4 Ft High)	Lf	1.5 mh/lf	\$39.00	\$45.30	\$1.00
Plywood Predetonation Screen (12 Ft Tall)	Lf	0.4 mh/lf	\$17.60/lf	\$13.15/lf	\$0.80/lf
Freestanding Soil Berm (6 Ft High)	Lf	0.3 mh/lf	\$0.00	\$11/lf	\$17.60/lf
Fabric-Reinforced Soil Berm (6 Ft High)	Lf	0.32 mh/lf	\$4.60/lf	\$11.60/lf	\$17.60/lf
Sand Grid Wall (6 Ft High)	Lf	0.4 mh/lf	\$56.50/lf	\$13.85/lf	\$4.90/lf
Hesco-Bastion Concertainer Wall					
Plywood Parallel Walls Soil-Bin Revetment (11 Ft High)	Lf	1.53 mh/lf	\$299.90/lf	\$55.80/lf	\$14.75/lf
Counter mobility Measures					
Triangular Ditch (5 Ft Deep)	Lf	0.049 mh/lf	\$0.00	\$1.43/lf	\$2.28/lf
Sidehill Cut Ditch (7.5 Ft Deep)	Lf	0.0208 mh/lf	\$0.00	\$0.56/lf	\$1.73/lf
Trapezoidal Ditch (6 Ft Deep)	Lf	0.102 mh/lf	\$0.00	\$3.00/lf	\$4.80/lf
Precast Concrete Median Barrier	Lf	0.66 mh	\$275.00	\$21.00	\$21.00
Cable Reinforced Existing Chain Link (200 Ft Segment)	Ea	12 mh	\$1,646.00	\$381.00	\$134.00
Post And Cable Barrier (200 Ft Segment)	Ea	32 mh	\$2,000.00	\$1.10	\$360.00
Cable And Drum Vehicle Barrier (200 Ft Segment)	Ea	15 mh	\$2,090.00	\$580.00	\$165.00

Table D-1 (continued)

Concrete Filled Pipe Bollard	Ea	2 mh	\$165.00	\$63.80	\$22.60
Removable Pipe Bollard	Ea	4 mh	\$288.00	\$127.55	\$45.25
Precast Concrete Pipe	Ea	1.5 mh	\$113.00	\$49.40	\$66.90
Earth-Filled Barrier	Ea	0.15 mh	\$41.00	\$475.00	\$7.00
Water Filled Barrier:	Ea	0.25 mh	\$300.00	\$3.50	\$0.00
Steel Hedgehog	Ea	3 mh	\$130.00	\$134.00	\$36.00
Log Hurdles (Set Of Four 8-Ft Long Hurdles)	Ea	4 mh	\$453.00	\$128.00	\$224.00
Post And Cable Gate	Ea	4 mh	\$445.00	\$128.00	\$44.00
Guardrail (Corrugated Steel)	Ea	0.038 mh	\$11.00	\$0.95	\$0.55
Guardrail (Cable Guide)	Ea	0.033 mh	\$8.25	\$0.75	\$0.50
Guardrail (Corrugated Steel)	Ea	0.036 mh	\$10.30	\$0.80	\$0.50
Cantilevered Crash Gate (12 Foot One Lane)	Ea	32 mh	\$15,600.00	\$1,120.00	\$740.00
Cantilevered Crash Gate (20 Foot Two Lane)	Ea	32 mh	\$23,900.00	\$1,120.00	\$740.00

APPENDIX E
BLANK WORKSHEETS

DESIGN CRITERIA SUMMARY WORKSHEET

Project or Building			Analyst												Date															
Assets	Asset Category	Asset Value Rating	Tactics																											
			Explosive and Incendiary Devices						Standoff Weapons						Entry Tactics				Surveillance and Eavesdropping						Contamination Tactics					
			Moving Vehicle Devices		Stationary Vehicle Devices		Hand Delivered Devices		Indirect Fire Weapons		Direct fire weapons		Forced Entry		Covert Entry		Visual Surveillance		Acoustic Eavesdropping		Electronic Emanations Eavesdropping		Airborne Contamination		Waterborne Contamination		Waterfront Attack			
			DBT	LOP	DBT	LOP	DBT	LOP	DBT	LOP	DBT	LOP	DBT	LOP	DBT	LOP	DBT	LOP	DBT	LOP	DBT	LOP	DBT	LOP	DBT	LOP	DBT	LOP		

DBT = Design Basis Threat severity level

LOP = Level of Protection

ASSET VALUE/AGGRESSOR LIKELIHOOD WORKSHEET

Project or Building					Asset										Analyst											
					Asset Category										Date											
Value Rating Factors					Sum of Value Factors	Value Rating ²	Potential Aggressors	Aggressor Goal ³	Aggressors	Likelihood Rating Factors											Sum of Likelihood Factors	Likelihood Ratings ⁷				
Criticality to User / Population Type ¹	Impact on National Defense	Replaceability	Political Sensitivity	Relative Value to User						Installation Location ⁴	Publicity Profile ⁴	Accessibility ⁴	Availability ⁴	Dynamics ⁴	Recognizability	Relative Value to Aggressor	Law Enforcement ⁴	Aggressors' Perception of Success	Threat Level	History ⁵ / Intentions ⁶			Operational Capability ⁶	Operating Environment ⁶	Activity ⁶	
General Population																										
								Unsophisticated Criminals																		
Critical Infrastructure and Operations and Activities									Sophisticated Criminals																	
								Organized Criminal Groups																		
Sensitive Information									Vandals																	
All Other Assets									Extremist Protesters																	
								Domestic Terrorists																		
Notes:									International Terrorists																	
											State Sponsored Terrorists															
											Saboteurs															
								Foreign Intelligence Services																		

1. Population Type applies to General Population only
2. Sum of Value Ratings ÷ 10 for Sensitive Information 15 for General Population; 20 for Critical Infrastructure and Operations and Activities; 25 for all other assets
3. G for mission related goal, P for publicity related goal, M for monetary related goal

4. Factors that should be same for all aggressors for given asset
5. Applies to all aggressors other than terrorists
6. Applies to Terrorists only
7. Sum of Likelihood Ratings ÷ 180

BUILDING COST AND RISK EVALUATION WORKSHEET

Project or Building	Asset	Analyst
	Baseline Building Category (<i>Table 3-1</i>)	Date

Tactic		Initial						Revised						Analysis		
		Design Basis Threat ²	LOP ^{3,4} or P ₁	Risk ^{4,7} Level	Standoff, Rm. Size, Stories, %	Cost ⁸ Increase (%)	Cost Incr. Sum	Threat Severity Level	LOP ^{3,4} or P ₁	Risk ^{4,7} Level	Standoff, Rm. Size, Stories, %	Cost ⁸ Increase (%)	Cost Incr. Sum	Change ¹¹ in Cost (%)	Change ¹² in Risk (%)	Ratio ¹³
Explosives and Incendiaries	Moving Vehicle Bomb ¹															
	Stationary Vehicle Bomb ¹															
	Hand Delivered Devices															
	• Exterior ¹															
	• Mail Room ⁹															
	• Loading Dock ⁹															
	• Entry Area ⁹															
Standoff Weapons	Indirect Fire Weapons															
	Direct Fire Weapons ¹⁰															
Entry Tactics	Forced Entry															
	• Exterior															
	• Interior ⁹															
	Covert Entry															
Surveillance and Eavesdropping	Visual Surveillance															
	Acoustic Eavesdropping															
	• Exterior															
	• Interior ⁹															
	Electronic Emanations Eavesdropping															
	• Exterior															
	• Interior ⁹															
Contam-ination	Airborne Contamination															
	Waterborne Contamination															
	Waterfront Attack															
Sum ¹⁴ (%)							Sum ¹⁴ (%)									

- | | | |
|---|---|---|
| <p>1. Use highest cost among these tactics 2. From Tactic, Threat Severity and LOP Worksheet</p> <p>3. Level of Protection or Initial Protection Level</p> <p>4. From Risk Level Calculation Worksheet</p> <p>5. One risk level for each tactic group</p> | <p>6. Risk level for aggressor whose threat severity level controls DBT (Tactic, Threat Severity, and LOP Wksht)</p> <p>7. Indicate which aggressor controls 8. From Appendix A or B or from other cost estimate</p> <p>9. Enter small, medium, or large room</p> | <p>10. Enter percentage of building perimeter protected</p> <p>11. (Revised cost sum – initial cost sum) ÷ initial cost sum</p> <p>12. (Revised risk level – initial risk level) ÷ initial risk level</p> <p>13. Change in risk ÷ change in cost</p> <p>14. Total building cost increase (w/o progressive collapse)</p> |
|---|---|---|

